

HR-*i* series

INSTRUCTION MANUAL

Analytical Balance

HR-300*i*

HR-202*i*

AND

A&D Company, Limited

© 2008 A&D Company Ltd. All rights reserved.

No part of this publication may be reproduced, transmitted, transcribed, or translated into any language in any form by any means without the written permission of A&D Company Ltd.

The contents of this manual and the specifications of the instrument covered by this manual are subject to change for improvement without notice.

Windows, Word and Excel are registered trademarks of the Microsoft Corporation.

Contents

Basic Operation

1.	Introduction	3
1.1.	About This Manual	3
1.2.	Features.....	3
1.3.	Compliance.....	4
2.	Unpacking the Balance	6
2.1.	Installing the Balance	7
3.	Precautions.....	7
3.1.	Before Use.....	7
3.2.	During Use.....	8
3.3.	After Use	9
3.4.	Power Supply	9
4.	Display Symbols and Key Operation.....	10
5.	Weighing Units	11
5.1.	Units	11
5.2.	Changing the Units.....	12
6.	Weighing	14
6.1.	Basic Operation (Gram Mode).....	14
6.2.	Dual ange	15
6.3.	Counting Mode (PCS).....	16
6.4.	Percent Mode (%)	18

Adapting To The Environment

7.	Response Adjustment	19
8.	Calibration.....	20
8.1.	Calibration Group	20
8.2.	Calibration Using an External Weight.....	21
8.3.	Calibration Test Using an External Weight	22

Selecting Functions

9.	Function Switch and Initialization	23
9.1.	Permit or Inhibit.....	23
9.2.	Initializing the Balance.....	24
10.	Function Table.....	25
10.1.	Setting the Function Table.....	28
10.2.	Details of the Function Table	28
10.3.	Description of the Class "Environment, Display"	30
10.4.	Description of the Item "Data Output Mode"	31
10.5.	Description of the Item "Data Format"	32
10.6.	Data Format Examples	34
11.	ID Number and GLP Report.....	36
11.1.	Setting the ID Number.....	36
11.2.	GLP Report.....	37
12.	Underhook	40

Interface And Communication

13.	Standard Input and Output Interface	41
13.1.	RS-232C Interface.....	41
13.2.	Connection to Peripheral Equipment.....	42
13.3.	Commands	44

Maintenance

14.	Maintenance	50
14.1.	Treatment of the Balance.....	50
14.2.	Error Codes	50
14.3.	Checking the Balance Performance and Environment.....	52
14.4.	Asking for Repair	52
15.	Specifications	53
15.1.	External Dimensions	54
15.2.	Options and Peripheral Instruments	55
16.	Terms/Index	58
16.1.	Terms	58
16.2.	Index	59

1. Introduction

This manual describes how the balances of HR-*i* series work and how to get the most out of them in terms of performance. Read this manual thoroughly before using the balance and keep it at hand for future reference.

1.1. About This Manual

This manual consists of the following five parts:

- Basic operationDescribes precautions, the balance's construction and basic operation.
- Adapting to the environment.....Describes response (and stability) adjustment to adapt to the environment where there is vibration or drafts, the way to maintain weighing precision in a variation of ambient temperature, calibration and calibration test.
- Selecting functionsDescribes functions of the balance.
- Interface and communicationDescribes the serial interface used for communicating with a computer that requests weighing data and controls the balance, and for use with a printer.
- MaintenanceDescribes maintenance, error codes, troubleshooting, specifications and options.

1.2. Features

- Response adjustment adapting to drafts and/or vibration.
- The data adapting to GLP, GMP and ISO can be output using the RS-232C serial interface.
- Underhook, for measuring density and weighing magnetic materials.
- Multiple weighing units with most of the common units used around the world.
- Standard RS-232C serial interface to communicate with a computer. Windows communication tools software (WinCT) to allow easy communication with a computer using Windows.

1.3. Compliance

1.3.1. Compliance With FCC Rules

Please note that this equipment generates, uses and can radiate radio frequency energy. This equipment has been tested and has been found to comply with the limits of a Class A computing device pursuant to Subpart J of Part 15 of FCC rules. These rules are designed to provide reasonable protection against interference when equipment is operated in a commercial environment. If this unit is operated in a residential area, it may cause some interference and under these circumstances the user would be required to take, at his own expense, whatever measures are necessary to eliminate the interference.
(FCC = Federal Communications Commission in the U.S.A.)

1.3.2. Compliance With EMC Directives

CE This device features radio interference suppression and safety regulation in compliance with the following Council Directives

Council directive 89/336/EEC EN61326 EMC directive

Council directive 73/23/EEC EN60950 Safety of Information Technology Equipment

- The CE mark is an official mandatory European marking.

Please note that any electronic product must comply with local laws and regulations when sold or used anywhere outside Europe.



A&D Instruments Ltd.
 111, Park Road, Aylesbury,
 Bucks, HP21 3JF, UK
 Tel: +44 (0)1295 242424
 Fax: +44 (0)1295 242425
 Email: info@ad-instruments.com
www.ad-instruments.com



A & D Instruments Ltd. hereby declare that the following weighing products conform to the requirements of the council directives on ...

Electromagnetic Compatibility (EMC) 89/336/EEC
 and
Low Voltage Equipment (LVD) 73/23/EEC amended by 93/68/EEC

provided that they bear the CE mark of conformity as shown above.

GH and HR-i Series

Standards applicable :

EN 61326 1997 +A1: 1998, +A2: 2001 Class B Electrical equipment for measurement, control and laboratory use - EMC requirements for emission and minimum requirements for immunity.

EN 60335-1:1991 Specification for safety of household and similar electrical appliances. LVD General requirements

EN 60950 Safety of Information Technology Equipment.

CE Mark first applied October 2004

Warning

These may be class A products. In a domestic environment these products may cause radio interference in which case the user may be required to take adequate measures.

Signed for A&D Instruments in Oxford England October 2005

Takeo Goto
Managing Director

...Clearly a Better Value



2. Unpacking the Balance

Unpack the balance carefully. Keep the packing material to be used for transporting the balance in the future. See the illustrations to confirm that everything is contained.

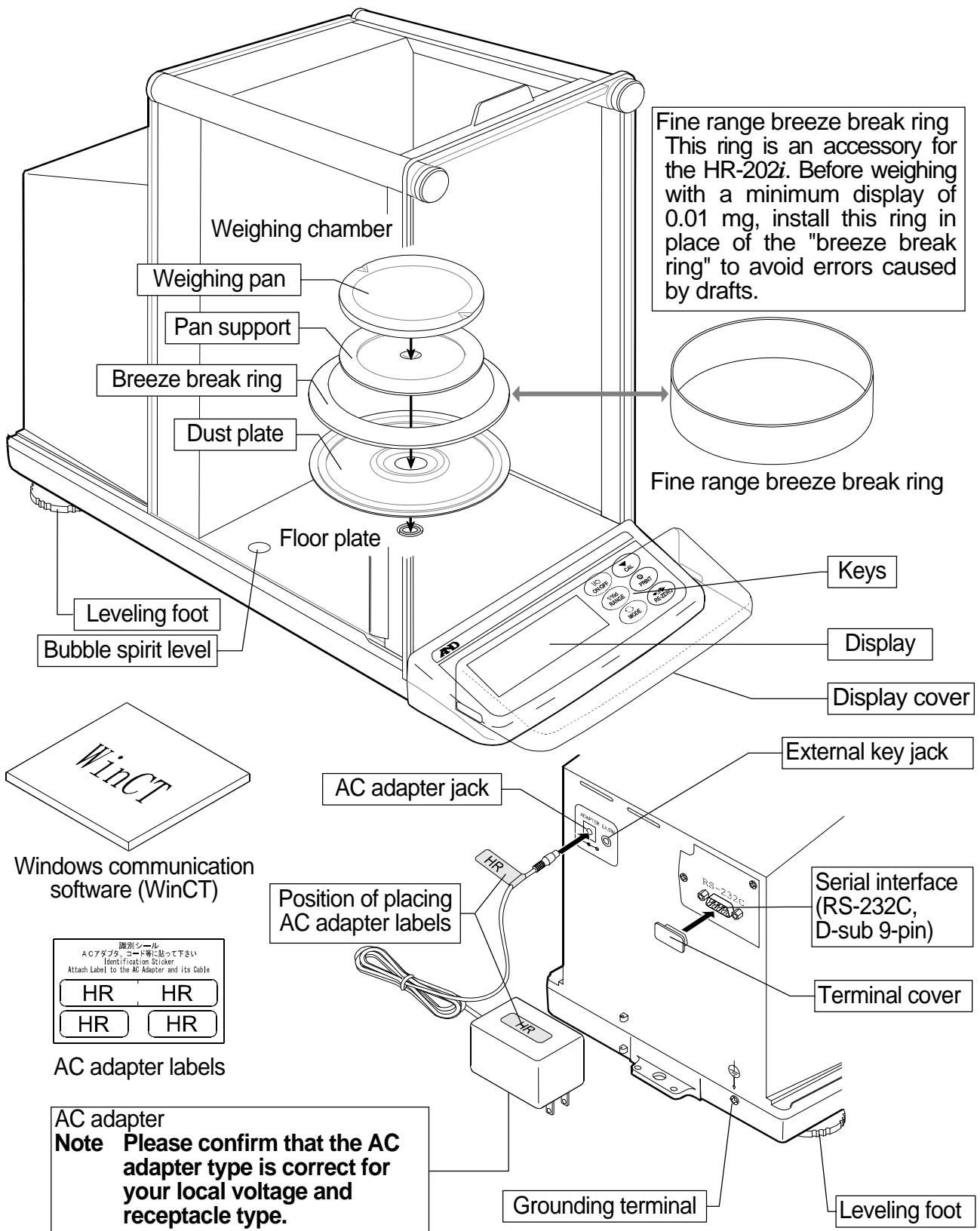

2.1. Installing the Balance

Install the balance as follows:

- 1 Consider section "3. Precautions " for installing your balance. Place the balance on a solid weighing table.
- 2 Assemble the "Dust Plate", "Breeze Break Ring" and "Weighing Pan" on your balance. There is a reference illustration on the previous page.
- 3 Adjust the level of the balance using the leveling feet. Ground the balance chassis for discharging static electricity if you have a static problem.
- 4 Please confirm that the adapter type is correct for your local voltage and power receptacle type.
- 5 Connect the AC adapter to the balance.
- 6 Calibrate the balance before use. Refer to "8. Calibration".

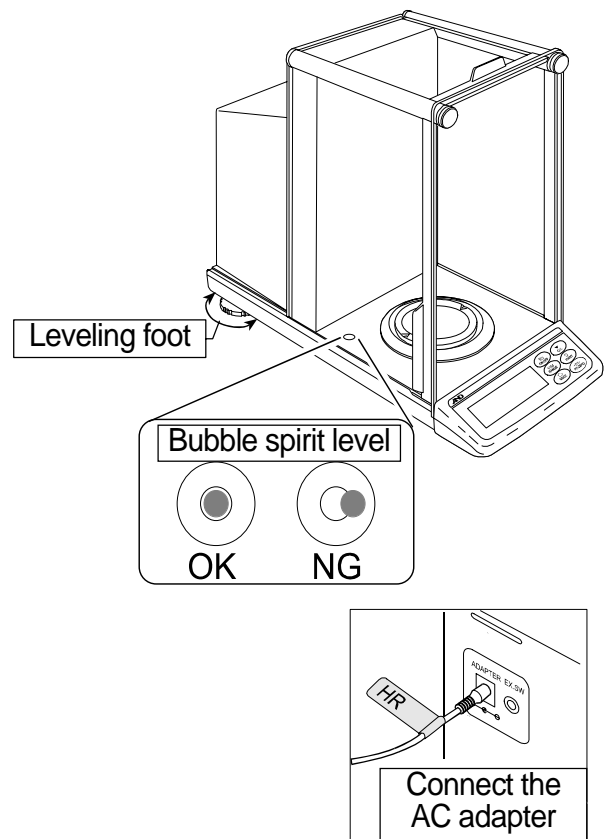

3. Precautions

3.1. Before Use

To ensure that you get the most from your balance, please try to follow these conditions as closely as possible.

- Please confirm that the AC adapter type is correct for your local voltage and receptacle type.
- Ensure a stable power source when using the AC adapter.
- The best operating temperature is about 20°C / 68°F at about 50% Relative Humidity.
- The weighing room should be free of dust.
- The weighing table should be solid and free from vibration, drafts (such as frequently opening doors or windows) and as level as possible.
- Corners of rooms are best as they are less prone to vibration.
- Do not install the balance near a heater or air conditioner.
- Do not install the balance in direct sunlight.
- Do not use the balance near other equipment which produces magnetic fields.
- Keep the balance level by using the bubble spirit level.
- Please warm-up the balance for at least one hour. Plug in the AC adapter as usual.
- Calibrate the balance before using and after moving it to another location.

⚠ Do not place or use the balance where there is flammable or corrosive gas present.

3.2. During Use

Note the following items to get accurate weighing data.

- Discharge static electricity from the weighing material.
When a weighing sample (plastics, insulator, etc.) could have a static charge, the weight value is influenced. Ground the balance, and
 - Eliminate the static electricity using the optional AD-1683.
 - Try to keep the ambient humidity above 45%RH.
 - Use a metal shield case.
 - Wipe a charged plastic sample with a damp cloth.

- This balance uses a strong magnet as part of the balance assembly, so please use caution when weighing magnetic materials. If there is a problem, use the underhook (on the bottom of the balance) to suspend the material away from the influence of the magnet.

- Eliminate the temperature difference between the weighed sample and the environment. When a sample is warmer (cooler) than the ambient temperature, the sample will lighter (heavier) than true mass. This error is due to the rising (falling) draft around the sample.

- Make each weighing gently and quickly to avoid errors due to changes in the environmental conditions.

- Before weighing with a minimum display of 0.01 mg for the HR-202i, the "fine range breeze break ring" can be installed in place of the "breeze break ring" to avoid errors caused by drafts.

- Do not drop things upon the weighing pan, or place a weight beyond the range of the balance on the weighing pan.

- Do not use a sharp instrument (such as a pencil or ball point pen) to press the keys, use your finger only.

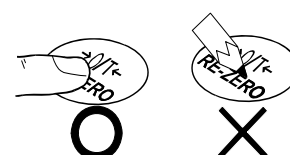
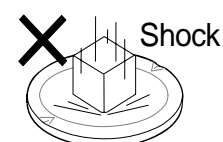
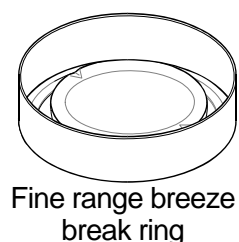
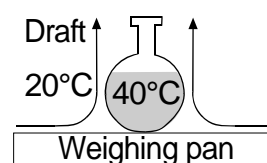
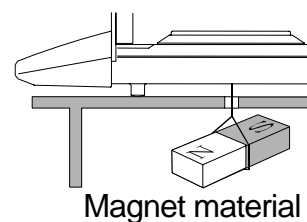
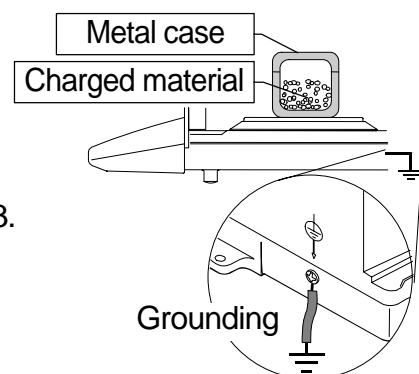

- Press the **RE-ZERO** key before each weighing to prevent possible errors.
- Calibrate the balance periodically so as to eliminate possible errors.
- Take into consideration the affect of air buoyancy on a sample when more accuracy is required.
- Avoid foreign matter (dust, liquid or metal fragments) that could get inside the balance.
- Operate your balance gently. Shorten the operation time as much as possible (Opening and closing door, placing and removing a sample). Use a pair of tweezers to avoid temperature changes due to heat from inserting your hand into the weighing chamber.

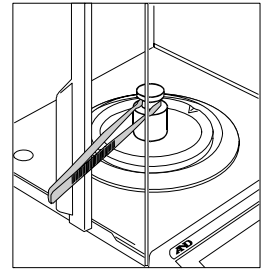

3.3. After Use

- Avoid mechanical shock to your balance.
- Do not disassemble the balance. Contact the local A&D dealer if your balance needs service or repair.
- Do not use solvents to clean the balance. For best cleaning, wipe with a dry lint free cloth or a lint free cloth that is moistened with warm water and a mild detergent.
- Avoid foreign matter (dust, liquid or metal fragments) that could get inside the balance.

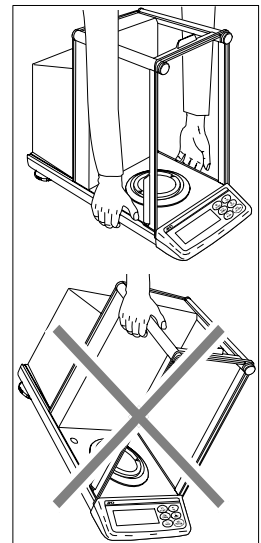

3.4. Power Supply

- When the AC adapter is connected, the balance is in the standby mode if the standby indicator is on. This is a normal state and does not harm the balance. For accurate weighing, we recommend that the AC adapter always be connected.

4. Display Symbols and Key Operation



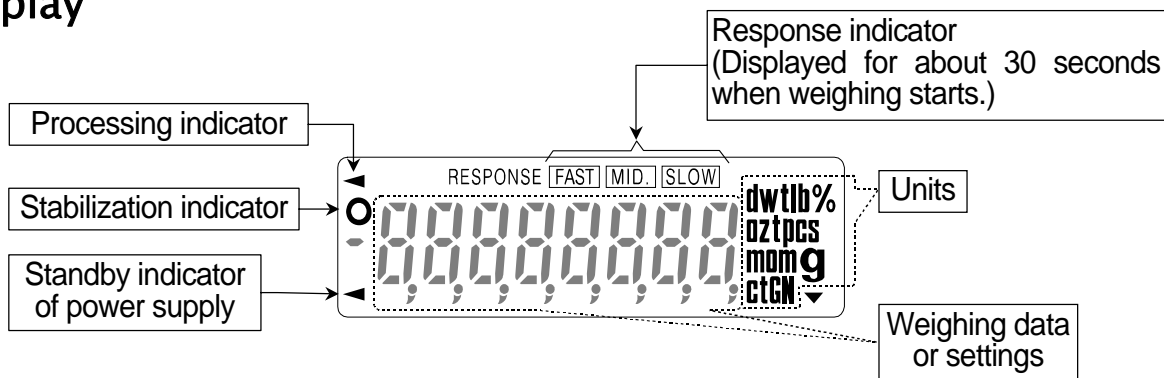



Display

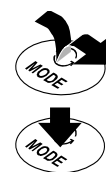

Key operation

- Press and release the key immediately" or "Click the key"
- Press and hold the key



Key	When pressed and released	When pressed and held
	The key to turn the display ON and OFF. <ul style="list-style-type: none"> □ The standby indicator is displayed when the display is turned off. □ The weighing mode is enabled when the display is turned on. □ This key is available anytime. □ Pressing the key during operation will interrupt the operation and turn the display OFF. 	
	In the weighing mode, the key to turn the minimum weighing value ON and OFF.	The key to enter the function table mode. Refer to "10. Function Table".
	The key to switch the preset weighing units stored in the function table. Refer to "5. Weighing Units".	The key to perform response adjustment.
	No function.	The key to display other items of the calibration menu.
	The key to output the stable weighing data. (factory setting)	<ul style="list-style-type: none"> □ No function. (factory setting) □ By changing the function table: "Title block" and "End block" for GLP report are output.
	The key to set the display to zero.	

5. Weighing Units

5.1. Units

- All weighing units and weighing modes are as follows:

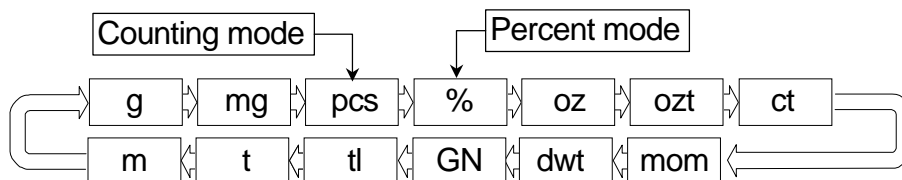

- A unit or mode can be selected and stored in the function table as described in "5.2. Changing the Units".
- If the law in your area permits, you may use all of the units. You can disable the units that you don't regularly use. And you are able to turn them back on.
- If a weighing mode (or unit of mass) has been turned off, that mode or unit will be missing in the sequence. Tael has four varieties, one of which can be selected and installed at the factory.
- To select a unit or mode for weighing, press the **MODE** key.
- For details about the units and modes, see the table below:

Name (unit, mode)	Abbreviation	Display unit	Conversion factor
Gram	g	g	1 g
Milligram	mg	mg	0.001 g
Counting mode	pcs	pcs	-
Percent mode	%	%	-
Ounce (Avoir)	oz	oz	28.349523125 g
Troy Ounce	ozt	ozt	31.1034768 g
Metric Carat	ct	ct	0.2 g
Momme	mom	mom	3.75 g
Pennyweight	dwt	dwt	1.55517384 g
Grain (UK)	GN	GN	0.06479891 g
Tael (HK general, Singapore)	tl	tl	37.7994 g
Tael (HK jewelry)			37.429 g
Tael (Taiwan)			37.5 g
Tael (China)			31.25 g
Tola (India)	t	t	11.6638038 g
Messghal	m	m	4.6875 g

5.2. Changing the Units

- The units or modes can be selected and stored in the function table. The sequence of displaying these can be arranged to fit the frequency of use. The units stored are maintained in non-volatile memory, even if the AC adapter is removed.

1 Press and hold the **[RANGE]** key until **bASFnC** of the function table is displayed in the weighing mode, then release the key.

2 Press the **[RANGE]** key several times to display **Unit**.

3 Press the **[PRINT]** key to enter the unit selection mode.

4 Specify a unit or mode in the order to be displayed using the following keys.

[RANGE] key To display the units sequentially.

[RE-ZERO] key To specify a unit or mode.

The stabilization indicator **○** appears when the displayed unit or mode is specified.

Examples

Unit		Display
Gram	g	○ Unit g
Milligram	mg	○ Unit mg
Counting mode	pcs	○ Unit pcs
Percent mode	%	○ Unit %

5 Press the **[PRINT]** key to store the units or modes. The balance displays **End** and then displays the next menu item of the function table.

6 Press the **[CAL]** key to exit the function table. Then the balance returns to the weighing mode with the selected unit.

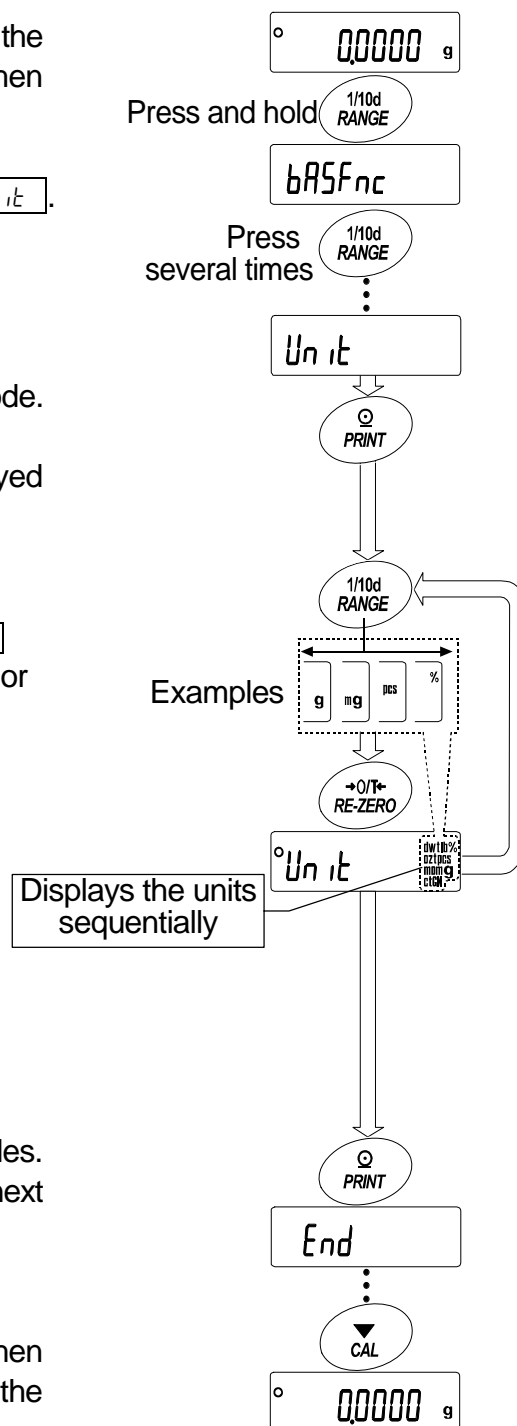

5.2.1. Unit setting example

The example below sets the units in the order with g (gram) as the first unit followed by pcs (counting mode).

- 1 Press and hold the **RANGE** key until **bASFnC** of the function table is displayed in the weighing mode, then release the key.
- 2 Press the **RANGE** key several times to display **Unit**.
- 3 Press the **PRINT** key to enter the unit selection mode.
- 4 Press the **RE-ZERO** key to specify the unit of g. The stabilization indicator **○** appears when the unit is specified.
- 5 Press the **RANGE** key several times to display **Unit pcs**.
- 6 Press the **RE-ZERO** key to specify the unit of pcs. The stabilization indicator **○** appears when the unit is specified.
- 7 Press the **PRINT** key to store the units. The balance displays **End** and then displays the next menu item of the function table.
- 8 Press the **CAL** key to exit the function table. Then the balance returns to the weighing mode with g, the unit selected first.
- 9 Press the **MODE** key to switch between g and pcs (g→pcs).

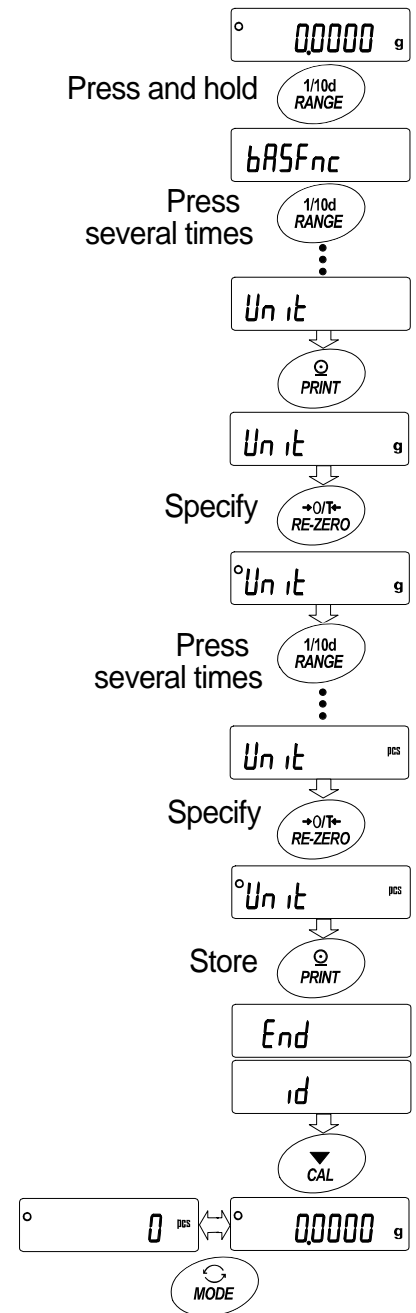

6. Weighing

Precautions for the weighing operation

- Press the **RE-ZERO** key each time, before placing a sample on the weighing pan, to prevent possible errors.
- Place a sample in the center of the weighing pan gently.
- Temperature changes during measurement may cause a weighing error.
- Shorten the operation time as much as possible. (Opening and closing door, placing and removing a sample)
- Use a pair of tweezers to avoid a temperature change due to having your hand in the weighing chamber.
- Material with an electrostatic charge or that is magnetic may cause a weighing error.
- Do not press keys with a sharp instrument (such as a pencil or ball point pen).
- Do not drop things on the pan, or place a weight on the pan that is beyond the weighing range of the balance.
- Calibrate your balance periodically to maintain weighing accuracy. Refer to section "8. Calibration".
- Keep the area clean and dry.
- Consider section "3. Precautions" for the weighing operation.
- For precision weighing, keep the AC adapter connected to the balance.

6.1. Basic Operation (Gram Mode)

Read section "4. Display symbols and Key operation" before operation.

Note When turning on the balance with a container placed on the pan, the tare function sets the display to zero automatically.

- 1 Turn on the balance using the **ON:OFF** key.
- 2 Select a preset unit (g or mg) using the **MODE** key.
- 3 Place the container on the weighing pan, if necessary.
Press the **RE-ZERO** key to cancel the weight (tare). Then zero is displayed.
Container : A vessel placed on the pan, but not to be included in the weighing data.
- 4 Place a sample on the pan or in the container.
- 5 Wait for the stabilization indicator **○** to be displayed, then read the value.
- 6 Remove the sample and container from the pan.

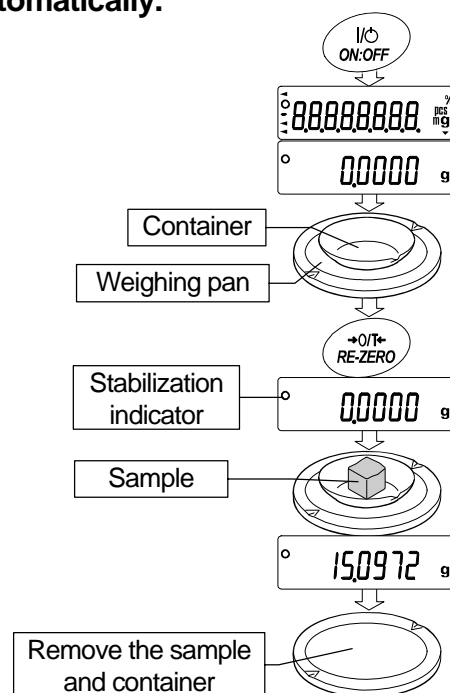

6.2. Dual Range

	HR-202i			
	Weighing range	Available minimum display		
Precision range	0 g to 51 g	0.01 mg	0.1 mg	1 mg
Standard range	51 g to 220 g	0.1 mg		1 mg

The HR-202i is equipped with two ranges, "precision range" and "standard range".

- When weighing is started by pressing the **ON:OFF** key, the minimum display will be 0.1 mg.
- Pressing the **RANGE** key will switch these ranges alternately.

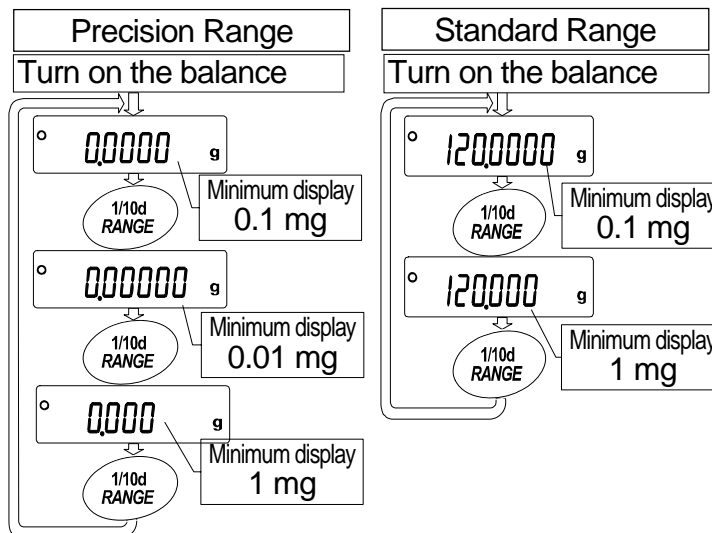

- When a sample is weighed using the precision range with a minimum display of 0.01 mg and the weight value exceeds the precision range value, the minimum display changes to 0.1 mg of the standard range. When removing the sample, the minimum display changes to 0.01 mg of the precision range automatically.

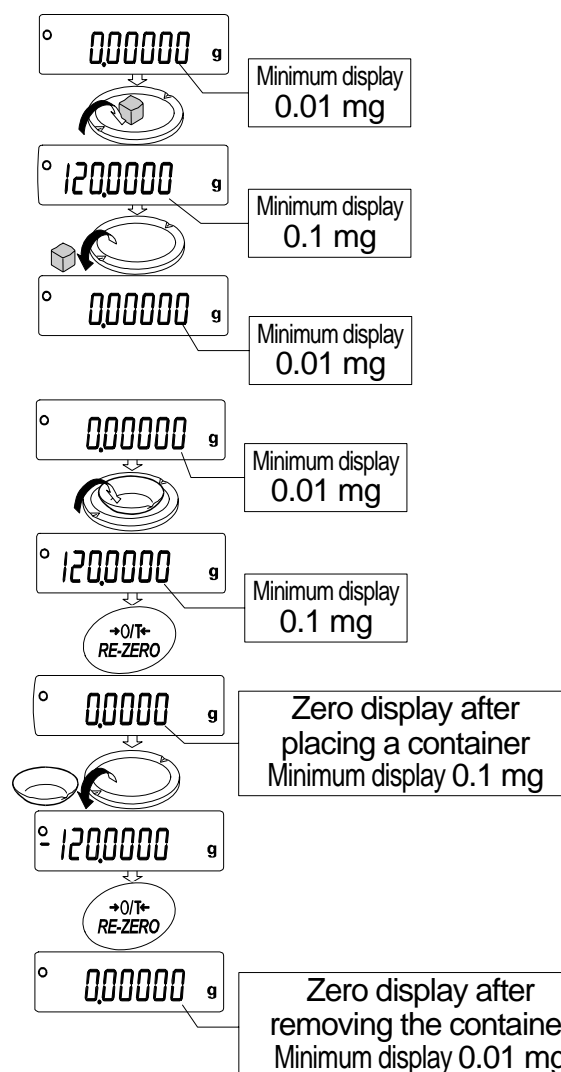

- When a tare weight (container mass value) exceeds the precision range value, even if the sample is within the precision range value, 0.01 mg of the precision range can not be selected for the minimum display. In order to select 0.01 mg of the precision range, remove the tare weight and press the **RE-ZERO** key to cancel it.
- When a minimum display of 0.1 mg or 1 mg is selected by the **RANGE** key, the minimum display is maintained even if the range is changed during weighing.

6.3. Counting Mode (PCS)

- This is the mode to determine the number of objects in a sample based on the standard sample unit mass. The unit mass means an average mass of the samples. The smaller the variation in the samples, the more accurate the count will be. The balance is equipped with the Automatic Counting Accuracy Improvement (ACAI) function to improve the counting accuracy.

Notes

- Use samples with a unit mass of 1 mg or more for counting.
- If the sample unit mass variable is too large, it may cause a counting error.
- To improve the counting performance, use the ACAI function frequently or divide the samples into several groups and count each group.

Selecting the counting mode

- 1 Press the **MODE** key to select the unit **pcs** (counting mode).

Storing a sample unit mass (Weighing input mode)

- 2 Press the **RANGE** key to enter the sample unit mass storing mode.

- 3 Select the number of samples using the **RANGE** key.

It may be set to 10, 25, 50 or 100.

Advise A greater number of samples will yield more accurate counting result.

- 4 Place a container on the weighing pan, if necessary. Press the **RE-ZERO** key to cancel the weight (tare). The number specified in step 3 appears.

Example: **25 0** pcs is displayed if 25 is selected in step 3.

- 5 Place the number of samples specified on the pan.

In this example, 25 pieces.

- 6 Wait for the stabilization indicator to be displayed .

Press the **PRINT** key to calculate and store the unit mass. Then the balance displays **25 pcs** and is set to count samples with this unit mass. (The sample unit mass is stored in non-volatile memory, and is maintained even if the AC adapter is removed.) To improve the accuracy of the unit mass, proceed to step 8.

Notes

- If the balance judges that the mass of the samples is too light (under 0.1 mg) and can not be stored as the unit mass, it displays **Lo**.
- If the balance judges that the mass of the samples is too light to acquire accurate weighing, it displays an error requiring the addition of more samples to the specified number.
Example: **50 - pcs** appears, requiring 25 more samples. Add 25 samples and press the **PRINT** key. When the unit mass is stored correctly, the balance proceeds to the counting mode.

Counting operation

- 7 Place the samples to be counted on the pan.

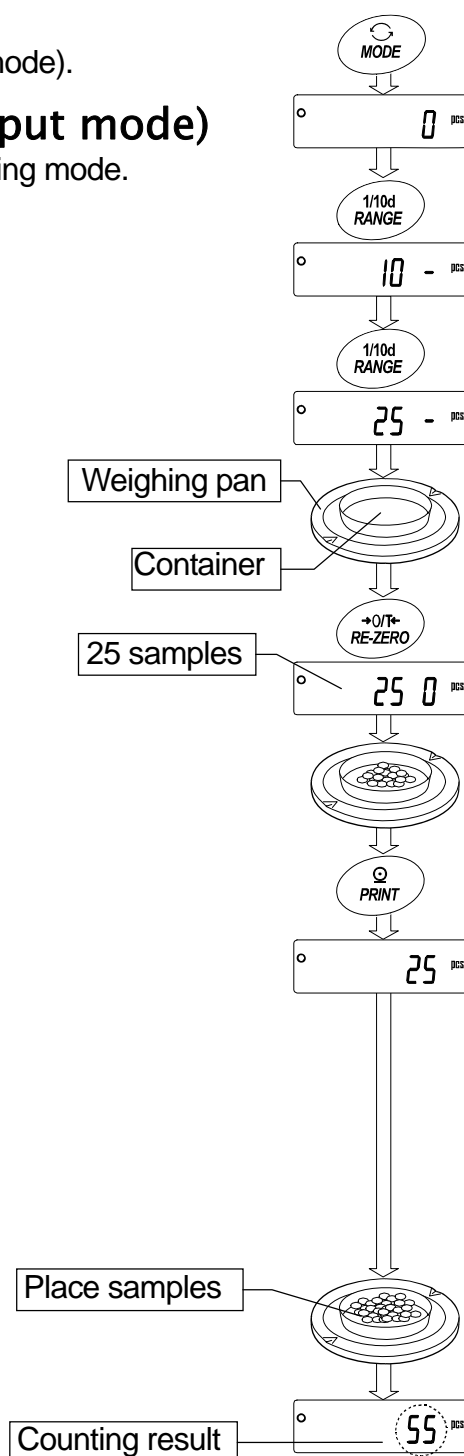

Counting mode using the ACAI function

The ACAI is a function that improves the accuracy of the unit mass automatically by increasing the number of samples as the counting process proceeds.

ACAI: Automatic Counting Accuracy Improvement

- 8 If a few more samples are added, the processing indicator turns on. To prevent an error, add three or more. The processing indicator does not turn on if overloaded. Add the same number of samples as displayed.
- 9 The balance re-calculates the unit mass while the processing indicator is blinking. Do not touch the balance or samples on the pan until the processing indicator turns off.
- 10 Counting accuracy is improved when the processing indicator turns off.
Each time the above operation is performed, a more accurate unit mass will be obtained. There is no definite upper limit to the ACAI range for the number of samples exceeding 100. Try to add the same number of samples as displayed.
- 11 Remove all the samples used in ACAI and proceed with the counting operation using the improved unit mass.

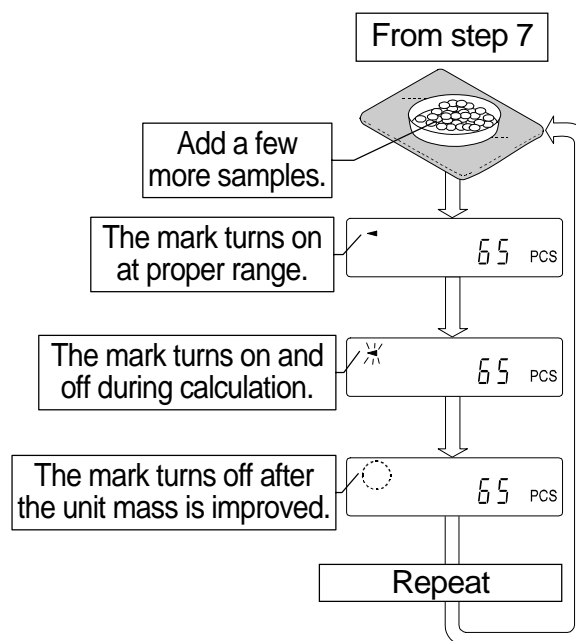

Note ACAI will not function on the unit mass entered using the keys, or digital input mode.

6.4. Percent Mode (%)

The percent mode displays the weight value in percentage compared to a 100% reference mass and is used for target weighing or checking the sample variance.

Selecting the percent mode

- 1 Press the **MODE** key to select the unit **%** (Percent mode).
If the percent mode can not be selected, refer to "5. Weighing Units".

Storing the 100% reference mass

- 2 Press the **RANGE** key to enter the 100% reference mass storing mode.
Even in the storing mode, pressing the **MODE** key will switch to the next mode.
- 3 Place a container on the weighing pan, if necessary. Press the **RE-ZERO** key to cancel the weight (tare). The balance displays **100 0 %**.
- 4 Place the sample to be set as the 100% reference mass on the pan or in the container.
- 5 Press the **PRINT** key to store the reference mass. The balance displays **100.00 %**. (The decimal point position depends on the reference value. The reference mass is stored in non-volatile memory, and is maintained even if the AC adapter is removed.)

Note

- The decimal point position depends on the 100% reference mass.

100% mass	Minimum display
0.0100g to 0.0999g	1%
0.1000g to 0.9999g	0.1%
1.0000g to weighing capacity	0.01%

- If the balance judges that the mass of the sample is too light (under 0.01g) to be used as a reference, it displays **Lo**.
- A 100% reference mass can be stored in the non-volatile memory and is maintained even if the AC adapter is removed.

- 6 Remove the sample.

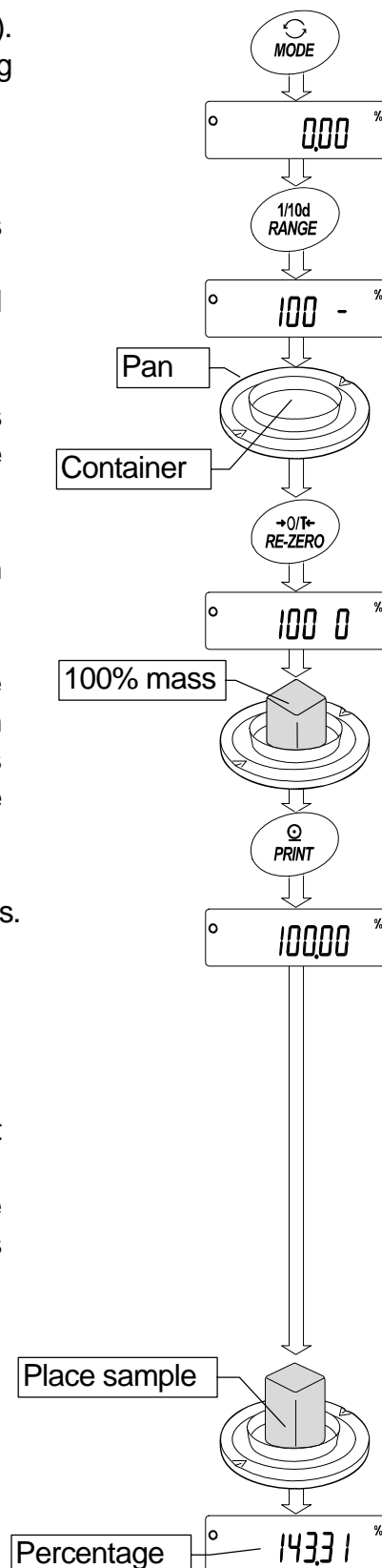

Reading the percentage

- 7 Place a sample to be compared to the reference mass on the pan. The displayed percentage is based on the 100% reference mass.



7. Response Adjustment

This function adjusts the response of the balance and reduces the influence of drafts and/or vibration at the place where the balance is installed. The function has three stages as follows :

Indicator	Parameter	Response	Stability
FAST	[Cond 0]	Fast response,  Sensitive value	Stable value 
MID.	[Cond 1]		
SLOW	[Cond 2]	Slow response, Stable value	

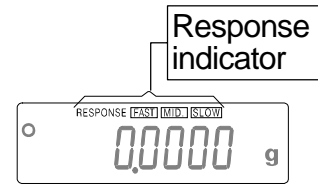

- 1 Press and hold the [MODE] key until [RESPONSE] is displayed, then release the key. Press the [MODE] key again quickly.
- 2 Select a stage of the response adjustment using the [MODE] key. Either [FAST], [MID.] or [SLOW] can be selected.
- 3 The balance automatically returns to the weighing mode and displays the updated response indicator for about thirty seconds.

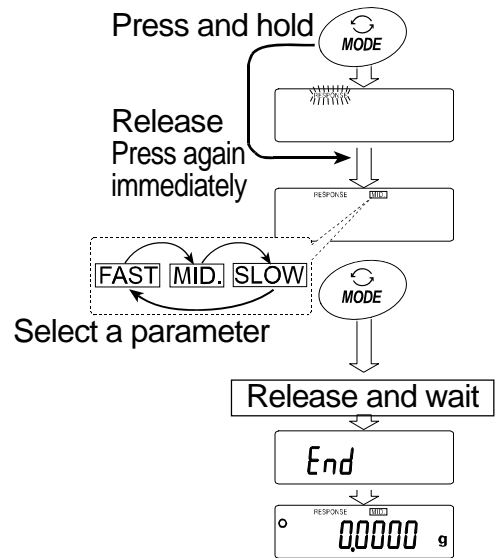

Advise

If the automatic response adjustment is not helpful, specify a parameter for "Condition ([Cond])" of "Environment, Display (bRSFnc)" with key operation.

8. Calibration

8.1. Calibration Group

Calibration

Calibration using a weight that you have

Calibration test

Calibration test using a target mass

Caution

- Do not allow vibration or drafts to affect the balance during calibration.
- Calibration test does not perform calibration.
- To output the data for GLP using the RS-232C interface, set "GLP output (*info*)" of "Data output (*dout*)". Refer to "10. Function Table".
- Calibration test is available only when "GLP output (*info*)" of "Data output (*dout*)" is set .

Caution on using an external weight

- The accuracy of an external weight can influence the accuracy of weighing.
- Select a mass for calibration and calibration test from the following table.

Model	Usable calibration mass	Adjustable range
HR-300 <i>i</i>	100g, 200g* , 300g	-15.0 mg to +15.9 mg
HR-202 <i>i</i>	20g, 50g, 100g, 200g*	-15.00 mg to +15.99 mg

The calibration mass in **bold type**: factory setting

The calibration mass value can be adjusted within the range above.

Display

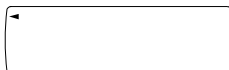

This indicator means "In process of measuring calibration data".

Do not allow vibration or drafts to affect the balance while the indicator is displayed.

8.2. Calibration Using an External Weight

This function calibrates the balance using an external weight.

- 1 Connect the AC adapter and warm up the balance for at least one hour with nothing on the weighing pan.
- 2 Press and hold the **[CAL]** key until **[CALout]** is displayed, then release the key.
- 3 The balance displays **[CAL 0]**.
 - If you want to change the calibration mass, press the **[RANGE]** key and proceed to step 4.
 - If you use the calibration mass value stored in the balance, proceed to step 5.
- 4 Specify the calibration mass value as follows:
 - [RANGE]** key..... The key to switch blinking figures.
 - [RE-ZERO](+)**key ... The keys to select the calibration mass or adjust the mass value. Refer to page 20.
 - [MODE](-)**key
 - [PRINT]** key..... The key to store the new mass value. Even if the AC adapter is removed, the data is maintained in non-volatile memory.
 - [CAL]** key..... The key to cancel the operation and return to **[CAL 0]**.
- 5 Confirm that there is nothing on the pan and press the **[PRINT]** key. The balance measures the zero point. Do not allow vibration or drafts to affect the balance. The balance displays the calibration mass value.
- 6 Place the displayed calibration weight on the pan and press the **[PRINT]** key. The balance measures the calibration mass. Do not allow vibration or drafts to affect the balance.
- 7 The balance displays **[End]**. Remove the weight from the pan.
- 8 If the "GLP output (*info*)" of the function table is set to 1 or 2, the balance displays **[GLP]** and outputs "Calibration Report". Refer to "11.2. GLP Report" for details.
- 9 The balance will automatically return to the weighing mode.
- 10 Place the calibration weight on the pan and confirm that the value displayed is correct. If it is not within the range, check the ambient conditions such as breeze and vibration also check the weighing pan. Then, repeat steps 1 to 10.

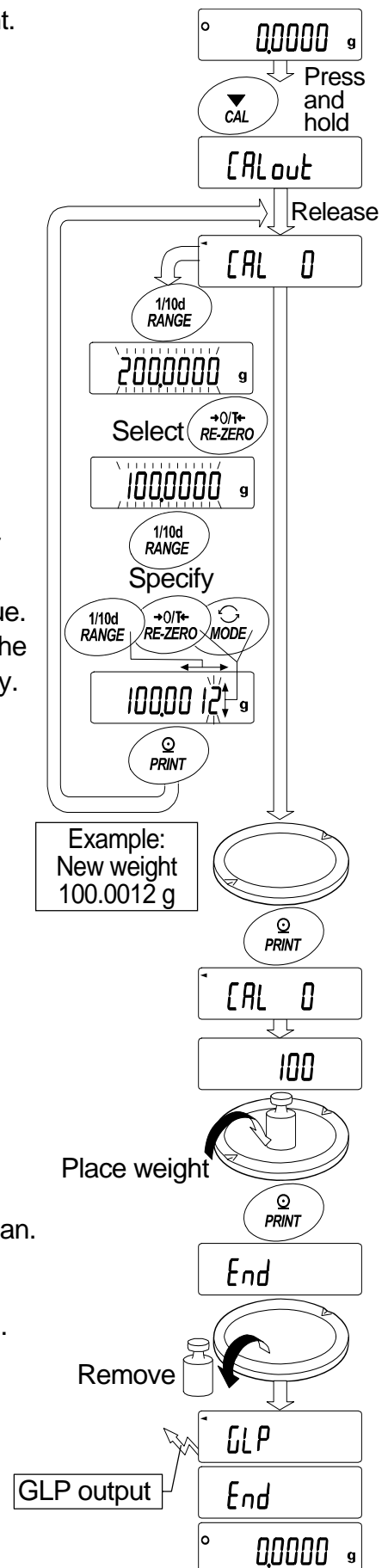

8.3. Calibration Test Using an External Weight

This function tests the weighing accuracy using an external weight. Calibration test report can be output with "GLP output (INF)" (Calibration test does not perform calibration).

- 1 Connect the AC adapter and warm up the balance for at least one hour with nothing on the weighing pan.
- 2 Press and hold the **CAL** key until **[[out** is displayed, then release the key.
- 3 The balance displays **[[0**.
 - If the target mass is changed, press the **RANGE** key and proceed to step 4. A list of usable weights is on page 20.
 - If the current target mass value is used, proceed to step 5.
- 4 Specify the target mass value as follows:
 - RANGE** key.....The key to switch blinking figures.
 - RE-ZERO**(+)**key**.....The keys to select the target mass or adjust the mass value. Refer to page 20. Even if the AC adapter is removed, the data is maintained in non-volatile memory.
 - MODE**(-)**key**
 - PRINT** key.....The key to store the new mass value.
 - CAL** key.....The key to cancel the operation and return to **[[0**.
- 5 Confirm that there is nothing on the pan and press the **PRINT** key. The balance measures the zero point and displays the measured value. Do not allow vibration or drafts to affect the balance. The balance displays the target mass value.
- 6 Place the displayed target mass on the pan and press the **PRINT** key. The balance measures the target mass and displays the measured value. Do not allow vibration or drafts to affect the balance.
- 7 The balance displays **End**.
Remove the weight from the pan.
- 8 The balance displays **GLP** and outputs "calibration test report. Refer to "11.2. GLP Report" of the function table for details.
- 9 The balance will automatically return to the weighing mode.

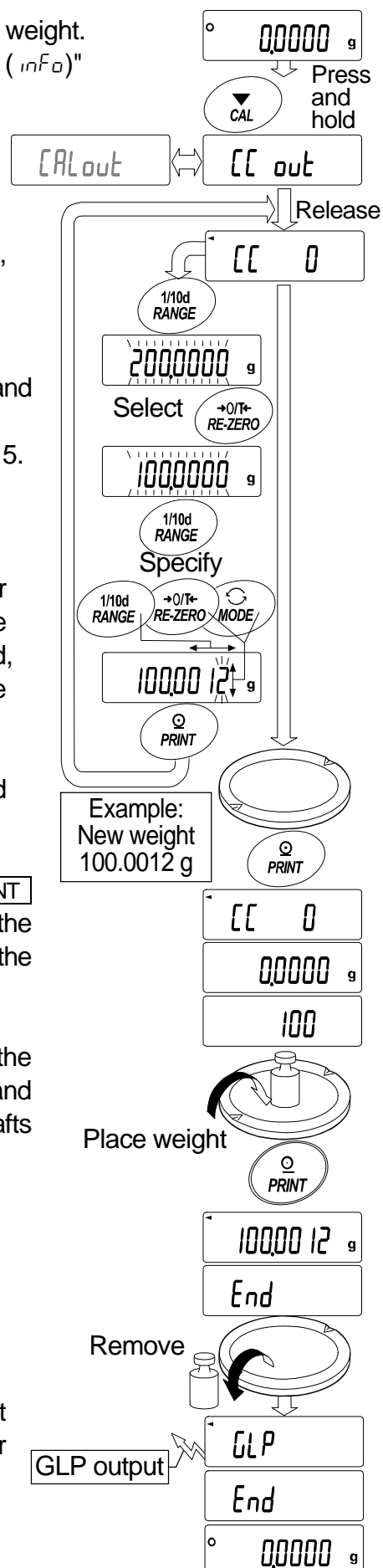

9. Function Switch and Initialization

9.1. Permit or Inhibit

The balance stores parameters that must not be changed unintentionally (Example: Calibration data for accurate weighing, Data for adapting to the operating environment, Control data for the RS-232C interface). There are two switches for the purpose of protecting parameters. Each switch can select either "permit" or "inhibit". "Inhibit" protects parameters against unintentional operations.

- 1 Press the **ON:OFF** key to turn off the display.
- 2 While pressing and holding the **PRINT** key and the **RANGE** key, press the **ON:OFF** key to display **P5** .
- 3 Press the **PRINT** key. Then the balance displays the function switches.
- 4 Specify the switches using the following keys.
 - RANGE** keyThe key to select blinking digit.
 - RE-ZERO** key.....The key to change the parameter for the selected switch.
 - To inhibit changes. (Can not be used.)
 - |** To permit changes. (Can be used.)
 - PRINT** keyThe key to store the new parameter and return to the weighing mode.
 - CAL** key.....The key to cancel the current operation and return to the weighing mode.

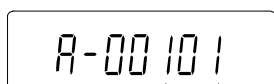

Function table

- To inhibit changes to the function table.
- |** To permit changes to the function table.

Calibration using the external weight

- To inhibit calibration using the external weight.
- |** To permit calibration using the external weight.

9.2. Initializing the Balance

This function returns the following parameters to factory settings.

- Calibration data
- Function table
- The sample unit mass value (counting mode),
100% reference mass value (percent mode)
- External calibration weight and target mass value
- Function switch settings ("9.1. Permit or Inhibit")

Note Be sure to calibrate the balance after initialization.

- 1 Press the **ON:OFF** key to turn off the display.
- 2 While pressing and holding the **PRINT** key and the **RANGE** key, press the **ON:OFF** key to display **P5**.
- 3 Press the **RANGE** key to display **[Lr**.
- 4 Press the **PRINT** key.
To cancel this operation, press the **CAL** key.
- 5 Press the **RE-ZERO** key to display **[Lr 00**.
- 6 Press the **PRINT** key to initialize the balance.
The balance will automatically return to the weighing mode.

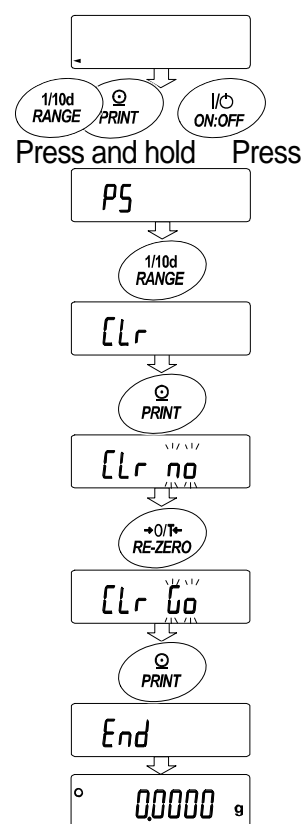





10. Function Table

The function table reads or rewrites the parameters that are stored in the balance. These parameters are maintained in non-volatile memory, even if the AC adapter is removed.

The function table menu consists of two layers. The first layer is the "Class" and the second layer is the "Item".

10.1. Setting the Function Table

Display symbol and keys

	The symbol "O" shows effective parameter.
	When pressing and holding the key in the weighing mode, the mode enters the function table mode. The key to select the class or item in the function table mode.
	The key to change the parameter.
	When displaying a class, the key enters an item in the class. When displaying an item, the key stores the new parameter and displays the next class.
	When displaying an item, the key cancels the new parameter and displays the next class. When displaying a class, the key exits the function table mode and returns to the weighing mode.

Setting procedure

- 1 Press and hold the **RANGE** key until **bASFnC** of the function table is displayed in the weighing mode, then release the key
- 2 Press the **RANGE** key to select a class.
- 3 Press the **PRINT** key to enter the class
- 4 Press the **RANGE** key to select an item.
- 5 Press the **RE-ZERO** key to select a parameter for the selected item.
- 6 If storing parameters of the selected class, press the **PRINT** key.
Then the next class is displayed.
If canceling the current operation, press the **CAL** key. Then the next class is displayed.
- 7 When specifying parameters for another class, proceed to step 2.
When finishing the setting, press the **CAL** key to return to the weighing mode.

Setting example

This example sets "CR" for "Terminator" and "Output" for "AK, Error code".

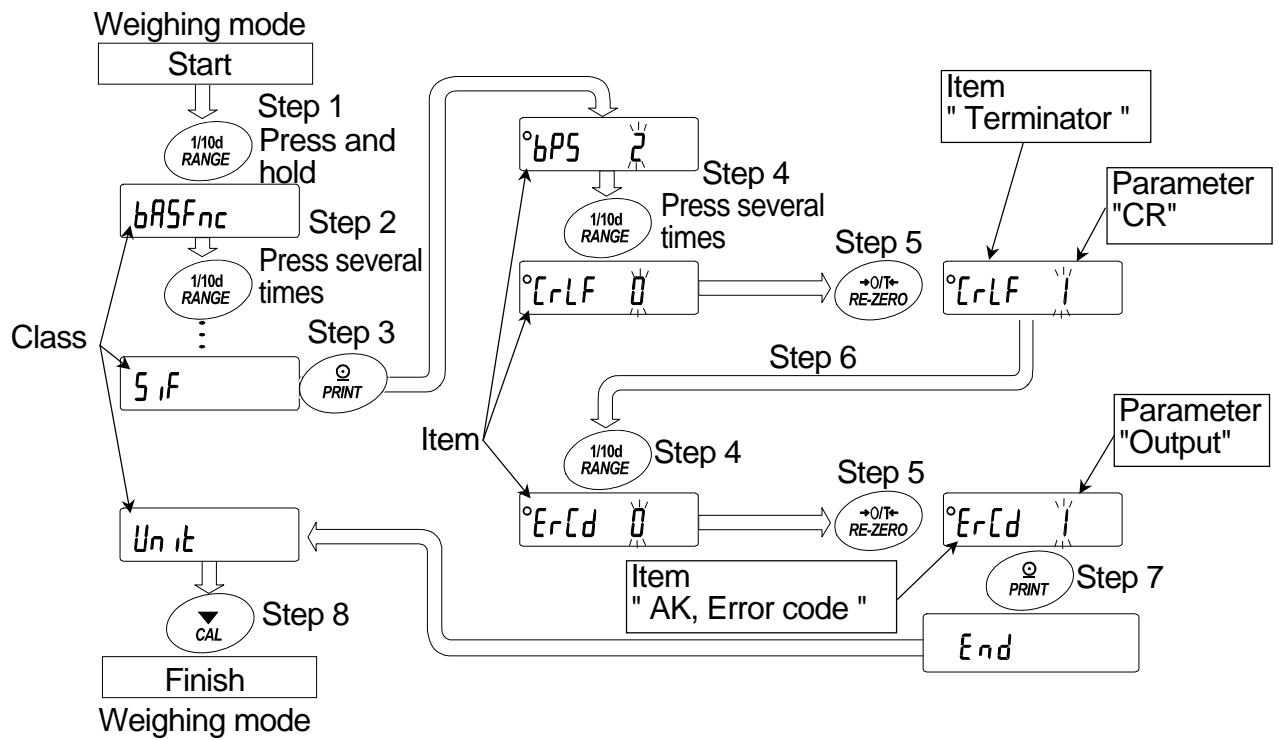

10.2. Details of the Function Table

Class	Item and Parameter	Description	
bRSFnc Environment Display	Cond Condition	0	Fast response, sensitive value FAST
		1	MID
	2	Slow response, stable value SLOW	
	St-b Stability band width	0	Stable range is ± 1 digit
		1	#1
	2	Stable range is ± 3 digits	
	Zrc Zero tracking	0	OFF
1		Normal	
2		Strong	
3	Very strong		
SPd Display refresh rate	0	5 times/second	
	1	10 times/second	
Pnt Decimal point	0	Point (.)	
	1	Comma (,)	
P-on Auto display-ON	0	OFF	
	1	ON	
dout Data output	Prt Data output mode	0	Key mode
		1	Auto print mode A (Reference = zero)
		2	Auto print mode B (Reference = last stable value)
	3	Stream mode	
	AP-P Auto print polarity	0	Plus only
		1	Minus only
		2	Both
	AP-b Auto print difference	0	10 digits
		1	100 digits
		2	1000 digits
	S-id ID number output	0	No output
		1	Output
PUSE Data output pause	0	No pause	
	1	Pause (1.6 seconds)	
Ae-F Auto feed	0	Not used	
	1	Used	
inFo GLP output	0	No output	
	1	AD-8121 format	
	2	General data format	
Ar-d Zero after output	0	Not used	
	1	Used	

▪ : Factory settings.

#1 The unit of minimum display is digit. Example: If 1 mg display is selected using the RANGE key for the HR-300i, 1 mg is one digit.

#2 Usable minimum display of the balance is one digit. Example: In gram display, one digit is 0.1 mg for the HR-300i, and 0.01 mg for the HR-202i.

Class	Item and Parameter	Description		
5 iF Serial interface	bPS Baud rate	0	600 bps	
		1	1200 bps	
		▪ 2	2400 bps	
		3	4800 bps	
		4	9600 bps	
		5	19200 bps	
	btPr Data bit, parity bit	▪ 0	7 bits, even	
		1	7 bits, odd	
		2	8 bits, none	
	CrLF Terminator	▪ 0	CR LF	CR: ASCII code 0Dh LF: ASCII code 0Ah
		1	CR	
	tYPE Data format	▪ 0	A&D standard format	Refer to "10.5. Description of Item "Data Format".
		1	DP format	
		2	KF format	
3		MT format		
4		NU format		
5		CSV format		
t-UP Timeout	0	No limit	Selects the wait time to receive a command.	
	▪ 1	1 second		
ErCd AK, Error code	▪ 0	No output	AK: ASCII code 06h	
	1	Output		
tTS CTS, RTS control	▪ 0	Not used	Controls CTS and RTS.	
	1	Used		
Unit Unit	Refer to "5. Weighing Units".			
id ID number setting	Refer to "11. ID Number And GLP Report".			

▪ : Factory settings. Digit is a unit of minimum weighing value.

Caution

The balance may not transmit the data completely at the specified refresh rate, depending on the baud rate or data added to the weighing data such as ID number. .

10.3. Description of the Class "Environment, Display"

Condition ($Cond$)

$Cond \ 0$ This parameter is for sensitive response to the fluctuation of a mass value. Used for powder target weighing, weighing a very light sample or when quick response weighing is required. After setting, the balance displays **FAST**.



$Cond \ 2$ This parameter is for stable weighing with slow response. Used to prevent a mass value from drifting due to vibration or drafts. After setting, the balance displays **SLOW**.

Stability band width ($St-b$)

This item controls the width to regard a mass value as a stable value. When the fluctuation per second is less than the parameter, the balance displays the stabilization indicator and outputs the data. The parameter influences the "Auto print mode"

$St-b \ 0$ This parameter is used for sensitive response of the stabilization indicator. Used for exact weighing.



$St-b \ 2$ This parameter ignores slight fluctuations of a mass value. Used to prevent a mass value from drifting due to vibration or drafts.

Zero tracking (Trc)

This function tracks zero point drift caused by changes in the environment and stabilizes the zero point. When the weighing data is only a few digits, turn the function off for accurate weighing.

$Trc \ 0$ The tracking function is not used. Used for weighing a very light sample.

$Trc \ 1$ The normal tracking function is used.

$Trc \ 2$ The strong tracking function is used.

$Trc \ 3$ The very strong tracking function is used. Used for stable zero display.

Display refresh rate (SPd)

The period to refresh the display. This parameter influences "Baud rate", "Data output pause" and "Stream mode".

Decimal point (Pnt)

The decimal point format can be selected.

Auto display-ON ($P-on$)

When the AC adapter is plugged in, the display is automatically turned on without the **ON:OFF** key operation, to display the weighing mode. Used when the balance is built into an automated system. one hour warm up is necessary for accurate weighing.

10.4. Description of the Item "Data Output Mode"

The parameter setting of "Data output mode (*Prt*)" applies to the performance when the data is transmitted using the RS-232C interface.

Key mode

When the **PRINT** key is pressed with the stabilization indicator turned on, the balance outputs the weighing data and the display blinks one time.

Required setting *dout* *Prt* 0 Key mode

Auto print modes A and B

When the displayed value is stable and the conditions of "Auto print polarity", "Auto print difference" and reference value are met, the balance outputs the weighing data.

When the **PRINT** key is pressed with the stabilization indicator turned on, the balance outputs the data and the display blinks one time.

Auto print modes A

Example For weighing each time a sample is placed and removed, with "*Pr-d*" set to "1" (to adjust zero after the data is output).

Required setting *dout* *Prt* 1 Auto print mode A (reference = zero)
dout *AP-P* Auto print polarity
dout *AP-b* Auto print difference
dout *Pr-d* 1 Zero after output

Auto print modes B

Example For weighing while a sample is added.

Required setting *dout* *Prt* 2 Auto print mode B (reference = last stable value)
dout *AP-P* Auto print polarity
dout *AP-b* Auto print difference

Stream mode

The balance outputs the weighing data continuously regardless of the display condition.

When the display refresh rate is set to 5 times/second (*SPd* 0), the data output rate is also set to the same 5 times/second. The display does not blink in this mode.

Example For monitoring data on a computer.

Required setting *dout* *Prt* 3 Stream mode
bRSFnc *SPd* Display refresh rate
SIF *bPS* Baud rate

Caution The balance may not transmit the data completely at the specified refresh rate, depending on the baud rate or data added to the weighing data such as ID number. .

10.5. Description of the Item "Data Format"

A&D standard format

S I F T Y P E 0

This format is used when the peripheral equipment can receive the A&D format.

If an AD-8121B is used, set the printer to MODE 1 or 2.

- This format consists of fifteen characters excluding the terminator.
- A header of two characters indicates the balance condition.
- The polarity sign is placed before the data with the leading zeros. If the data is zero, the plus sign is applied.
- The unit, consisting of three characters, follows the data.

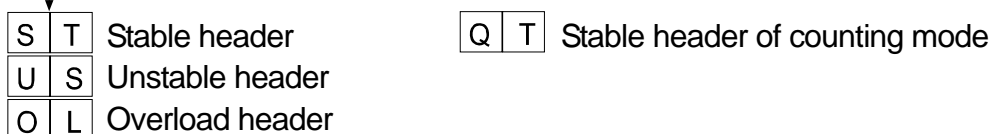
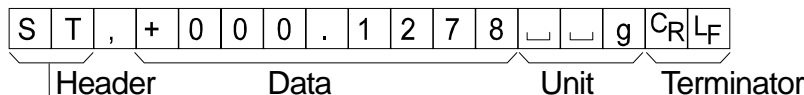

DP (Dump print) format

S I F T Y P E 1

This format is used when the peripheral equipment can not receive the A&D format.

If an AD-8121B is used, set the printer to MODE 3.

- This format consists of sixteen characters excluding the terminator.
- A header of two characters indicates the balance condition. No overload header is used.
- The polarity sign is placed before the data, with spaces in place of leading zeros, if the data is not zero or overloaded.
- The unit, consisting of three characters, follows the data.

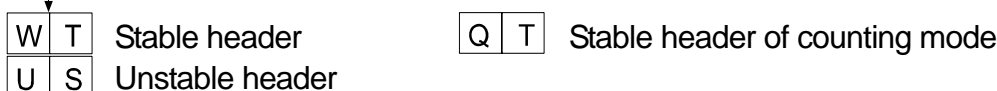
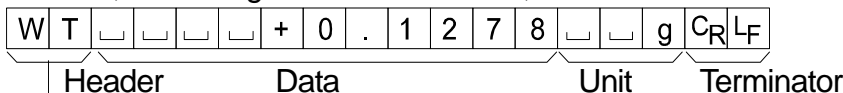

KF format

S I F T Y P E 2

This is the Karl-Fischer moisture meter format and is used when the peripheral equipment can only communicate using this format.

- This format consists of fourteen characters excluding the terminator.
- This format has no header characters.
- The polarity sign is placed before the data, with spaces in place of leading zeros, if the data is not zero or overloaded.
- This format outputs the unit only for a stable value.

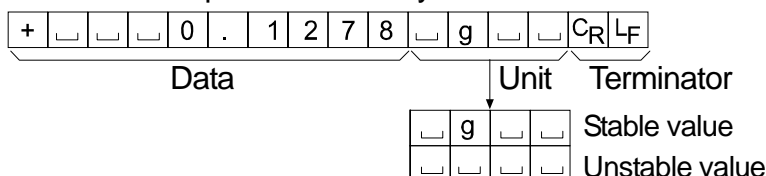

MT format

SIF TYPE 3

- A header of two characters indicates the balance condition.
- The polarity sign is used only for negative data.
- The weighing data uses spaces in place of the leading zeros.
- The character length of this format changes dependent upon the unit

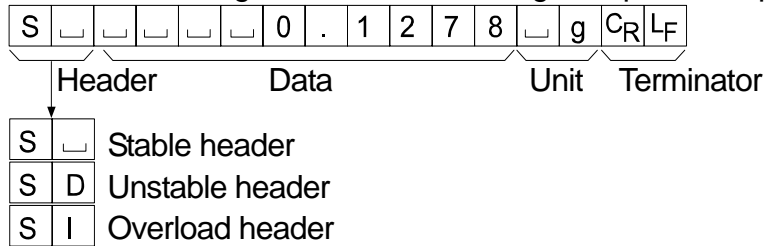

NU (numerical) format

SIF TYPE 4

This format outputs only numerical data.

- This format consists of ten characters excluding the terminator.
- The polarity sign is placed before the data with the leading zeros. If the data is zero, the plus sign is used.

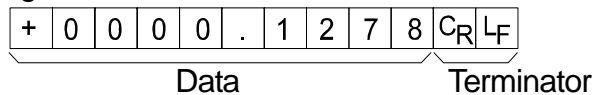

CSV format

SIF TYPE 5

- This format separates the data of A&D standard format and the unit by a comma (,).
- This format outputs the unit even when the data is overloaded.
- When a comma (,) is selected for the decimal point, the separators are set to semicolon (;).
- When the ID number and data number are added at "Data output (*dout*)" of the function table, outputs ID number, data number and weighing data in this order and separates each item by a comma and treats all the items as one group of data.

LAB-0123, ST,+0000.1278,□□g<CR><LF>

ID number
 Weighing data

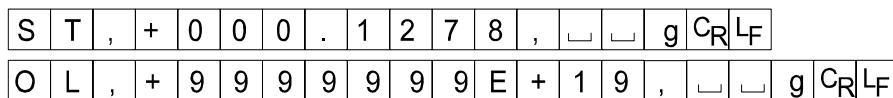

ID number

dout 5-id 1

The number to identify a specific balance.

- This format consists of eight characters excluding the terminator.

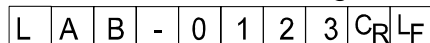

10.6. Data Format Examples

Stable

° 0.1278 g

A&D	S	T	,	+	0	0	0	.	1	2	7	8			g	CR	LF		
DP	W	T						+	0	.	1	2	7	8			g	CR	LF
KF	+				0	.	1	2	7	8			g				CR	LF	
MT	S					0	.	1	2	7	8			g			CR	LF	
NU	+	0	0	0	0	.	1	2	7	8							CR	LF	

Unstable

° -18.3690 g

A&D	U	S	,	-	0	1	8	.	3	6	9	0			g	CR	LF			
DP	U	S						-	1	8	.	3	6	9	0			g	CR	LF
KF	-				1	8	.	3	6	9	0							CR	LF	
MT	S	D						-	1	8	.	3	6	9	0			g	CR	LF
NU	-	0	0	1	8	.	3	6	9	0								CR	LF	

Overload

Positive error

E g

A&D	O	L	,	+	9	9	9	9	9	9	9	9	E	+	1	9			CR	LF	
DP													E							CR	LF
KF													H							CR	LF
MT	S	I	+																	CR	LF
NU	+	9	9	9	9	9	9	9	9	9	9	9								CR	LF

Overload

Negative error

-E g

A&D	O	L	,	-	9	9	9	9	9	9	9	9	E	+	1	9			CR	LF	
DP													-	E						CR	LF
KF													L							CR	LF
MT	S	I	-																	CR	LF
NU	-	9	9	9	9	9	9	9	9	9	9	9								CR	LF

□ Space, ASCII 20h
 CR Carriage Return, ASCII 0Dh
 LF Line Feed, ASCII 0Ah

Units

		A&D	D.P.	KF	MT
g	g	┌┌g┐	┌┌g┐	┌g┌┌┐	┌g┐
mg	mg	┌mg┐	┌mg┐	┌mg┌┐	┌mg┐
Counting mode	pcs	┌PC┐	┌PC┐	┌p c s┐	┌P C S┐
Percent mode	%	┌┌%┐	┌┌%┐	┌%┌┌┐	┌%┐
Ounce (Avoir)	oz	┌o z┐	┌o z┐	┌o z┌┐	┌o z┐
Troy Ounce	ozt	o z t	o z t	┌o z t┐	┌o z t┐
Metric Carat	ct	┌c t┐	┌c t┐	┌c t┌┐	┌c t┐
Momme	mom	m o m	m o m	┌m o m┐	┌m o┐
Pennyweight	dwt	d w t	d w t	┌d w t┐	┌d w t┐
Grain	GN	┌GN┐	┌GN┐	┌g r┌┐	┌GN┐
Tael (HK general, Singapore)	tl	┌t l┐	┌t l┐	┌t l s┐	┌t l┐
Tael (HK, jewelry)	tl	┌t l┐	┌t l┐	┌t l h┐	┌t l┐
Tael (Taiwan)	tl	┌t l┐	┌t l┐	┌t l t┐	┌t l┐
Tael (China)	tl	┌t l┐	┌t l┐	┌t l c┐	┌t l┐
Tola (India)	t	┌┌t┐	┌┌t┐	┌t o l┐	┌t┐
Messghal	m	m e s	m e s	┌M S┌┐	┌m┐

┌ Space, ASCII 20h

11. ID Number and GLP Report

- The ID number is used to identify the balance when Good Laboratory Practice (GLP) is used.
- The ID number is maintained in non-volatile memory even if the AC adapter is removed.
- The GLP output format is selected at "GLP output (info)" of the function table and can be output to a personal computer or printer using the RS-232C serial interface.
- The GLP output format includes the balance manufacturer, model, serial number, ID number, date column, time column and a space for signature for the weighing data, the weight used and results for calibration or calibration test data. When connecting the AD-8121B printer, the date and time can be printed using the clock function of the AD-8121B.
- The balance can output the following reports for GLP.
 - "Calibration report" of the calibration, using an external weight.
 - "Calibration test report" of the calibration test, using an external weight.
 - "Title block" and "End block" for the weighing data.

11.1. Setting the ID Number

- 1 Press and hold the **RANGE** key until **bR5FnC** of the function table is displayed, then release the key.
- 2 Press the **RANGE** key several times to display **id**.
- 3 Press the **PRINT** key. Set the ID number using the following keys.
 - RE-ZERO** key..... The key to set the character of the digit selected.
Refer to the display character set shown below.
 - RANGE** key..... The key to select the digit to change the value.
 - PRINT** key The key to store the new ID number and display **bR5FnC**.
 - CAL** key..... The key to cancel the new ID number and display **bR5FnC**.
- 4 With **bR5FnC** displayed, press the **CAL** key to return to the weighing mode.

0	1	2	3	4	5	6	7	8	9	-	_	A	B	C	D	E	F	G	H	I	J	K	L	M	N	O	P	Q	R	S	T	U	V	W	X	Y	Z
0	1	2	3	4	5	6	7	8	9	-	_	R	b	[d	E	F	G	H	i	U	L	n	n	o	P	q	r	S	t	U	u	v	w	x	y	z

_ Space

11.2. GLP Report

Set the following parameters to output the report.

- Refer to "13.2. Connection to peripheral equipment", for connection to an AD-8121B.
- To print the report, set the "GLP output (*inF_o*)" parameter to "1" and use MODE 3 of the AD-8121B. If MODE1 is used, select temporary dump print mode by pressing the **[STAT.]** key of the AD-8121B.
- To output the report to a personal computer using the RS-232C interface, set the "GLP output (*inF_o*)" parameter to "2".
- If the time and date are not correct, adjust the settings of the AD-8121B.

Calibration report using an external weight

Key operation

- 1 Press and hold the **[CAL]** key to display **[CAL out]** and release the key.
- 2 **[CAL 0]** is displayed.
- 3 When updating the calibration mass value, press the **[RANGE]** key and proceed to step 4. When using the preset calibration mass value, proceed to step 5.
- 4 Specify calibration mass value using the following keys.
 - [RANGE]** key The key to select the blinking figure
 - [RE-ZERO](+)**key .. The key to increase the value of the blinking figure.
 - [MODE](-)**key The key to decrease the value of the blinking figure.
 - [PRINT]** key The key to store the new value.
- 5 When pressing the **[RE-ZERO]** key, the zero point is measured and the weight value is displayed for a few seconds.
- 6 Place the displayed mass on the pan. Press the **[PRINT]** key to measure the mass and the weight value is displayed for a few seconds.
- 7 If GLP output is used, **[GLP]** is displayed and the calibration report is output.
- 8 The balance returns to the weighing mode after this calibration.

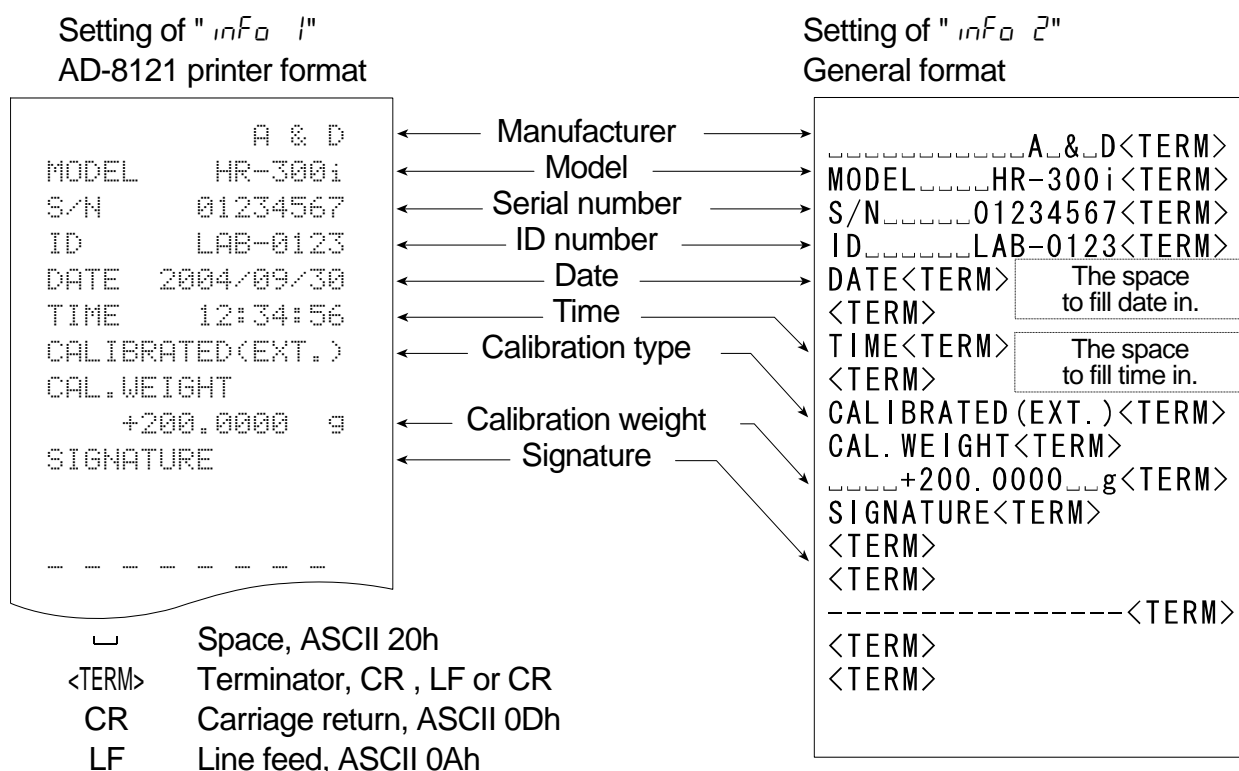

Calibration test report using an external weight

Note Calibration test does not perform calibration.

Key operation

- 1 Press and hold the **[CAL]** key to display **[EE out]** and release the key.
- 2 **[CAL 0]** is displayed.
- 3 When updating the target value, press the **[RANGE]** key and proceed to step 4.
When using preset target value, proceed to step 5.
- 4 Specify calibration mass value using the following keys.
[RANGE] key The key to select the blinking figure
[RE-ZERO](+)key .. The key to increase the value of the blinking figure.
[MODE](-)key The key to decrease the value of the blinking figure.
[PRINT] key The key to store the new value.
- 5 When pressing the **[RE-ZERO]** key, the zero point is measured and the weight value is displayed for a few seconds.
- 6 Place the displayed mass on the pan. Press the **[PRINT]** key to measure the mass and the weight value is displayed for a few seconds.
- 7 If GLP output is used, **[GLP]** is displayed and the calibration test report is output.
- 8 The balance returns to the weighing mode after this test.

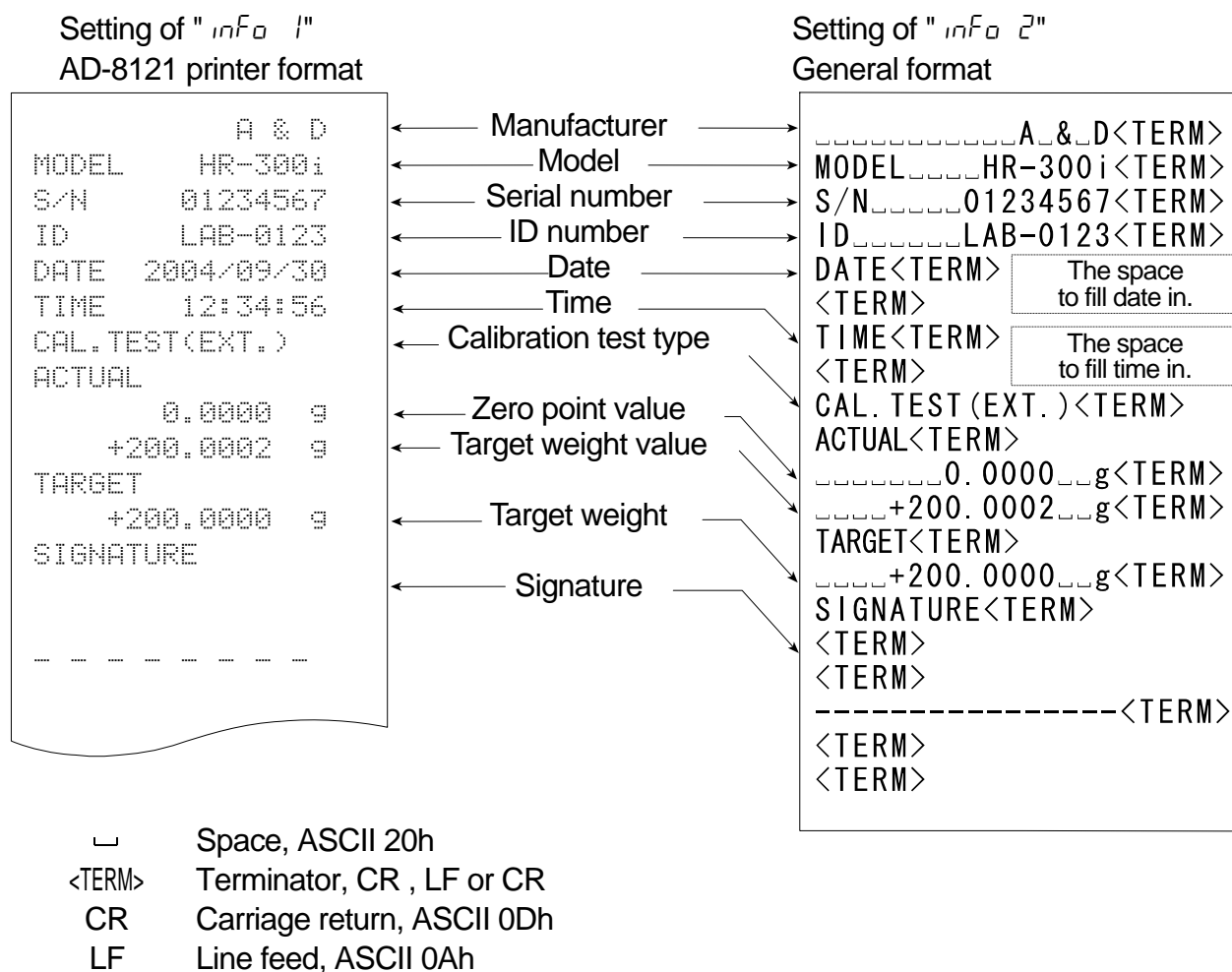

Title block and end block

When mass values are recorded as GLP data, a "Title block" is inserted at the beginning and an "End block" is inserted at the end of a group of mass values in the GLP report.

Notes

- To output the report to an AD-8121B, use MODE 3 of the AD-8121B. If MODE1 is used, select temporary dump print mode by pressing the **STAT** key of the AD-8121B.
- If the data memory function is used (except *DATA 0*), the "Title block" and "End block" can not be output.

Key operation

- 1 With the weighing data displayed, press and hold the **PRINT** key, then release the key. **Start** is displayed. The "Title block" is output.
- 2 The weighing data is output according to the parameter setting of the data output mode (*PrL*) of the function table.
- 3 Press and hold the **PRINT** key until **reEnd** is displayed, then release the key. The "End block" is output.

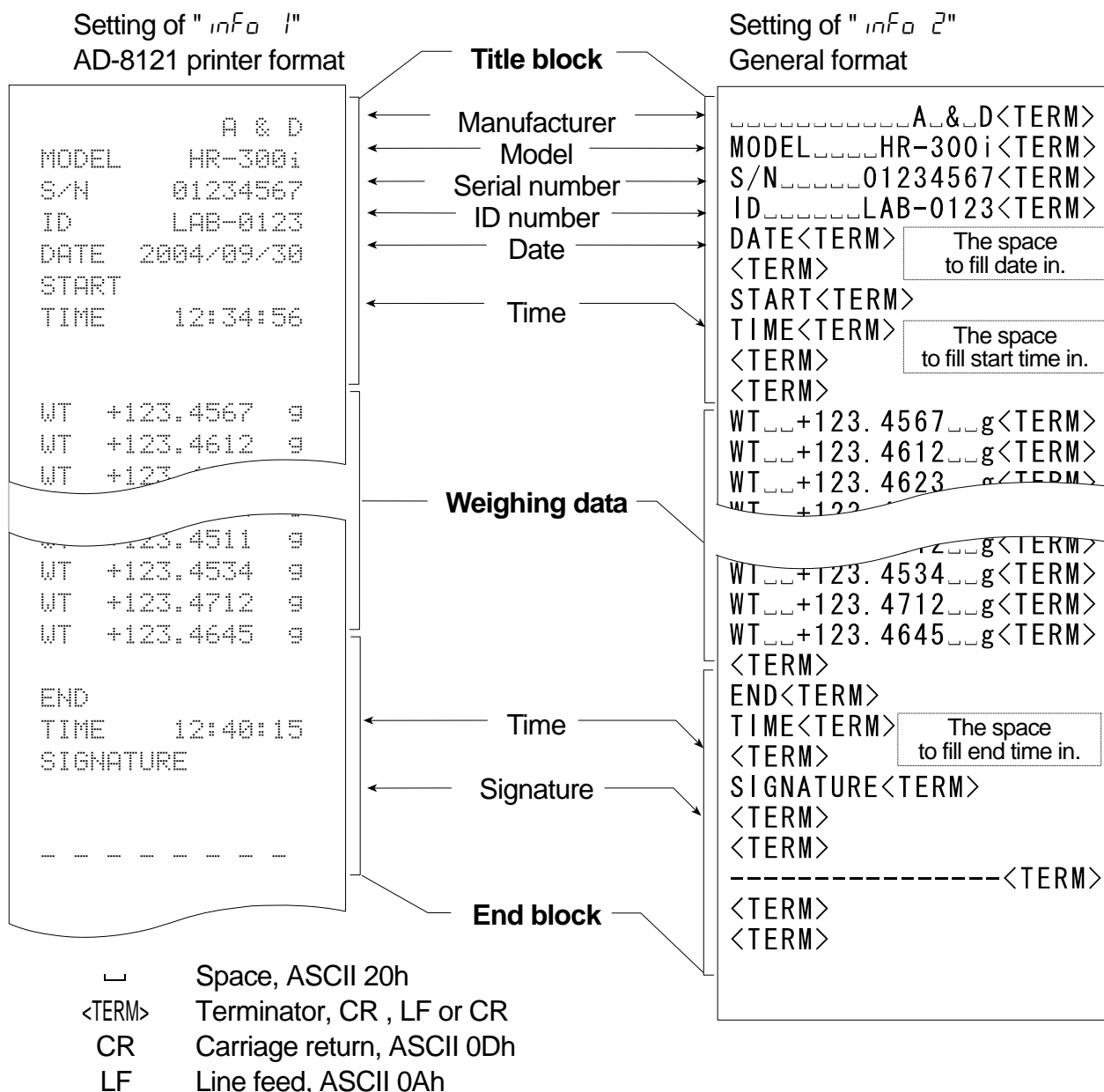

12. Underhook

The underhook can be used for magnetic materials or density measurement. The built-in underhook is revealed by removing the cap on the bottom of the balance. Use the underhook as shown at the lower right.

Caution

- Do not apply excessive force to the underhook.
- When not in use, attach the cap to prevent dust from getting into the balance.
- Do not push the underhook upward
- When turning the balance over, the weighing pan, pan support, breeze break ring and dust plate will fall off. Remove them first.
- When the cap is removed, a weighing error may occur, because of drafts entering into the internal portion of the balance. Arrange the room condition.

- 1 Remove the cap on the bottom of the balance.
- 2 Hang the weighing pan on the underhook.
Place the balance on the solid table.

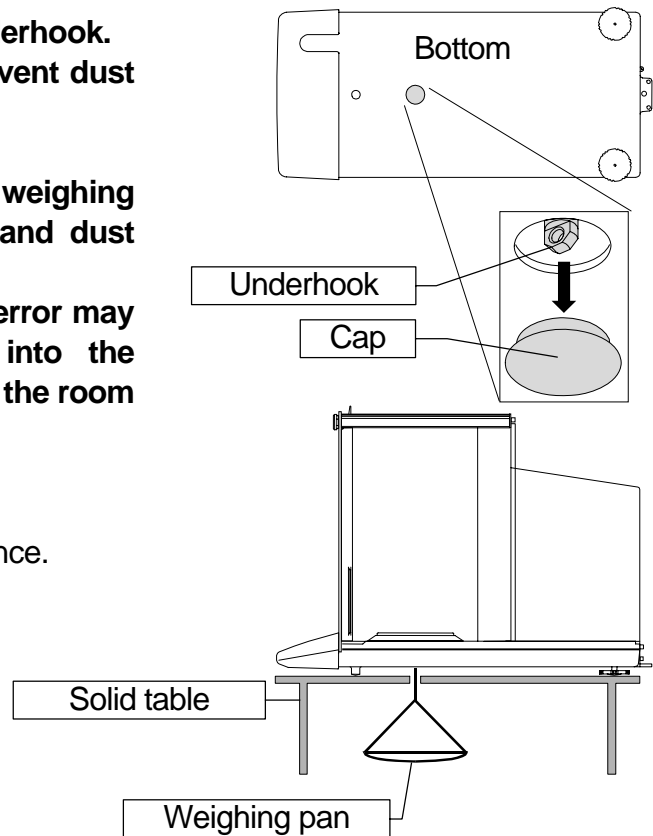

13. Standard Input and Output Interface

13.1. RS-232C Interface

The balance is a DCE device. Connect the balance to a personal computer (DTE) using a straight-through cable.

- Transmission system : EIA RS-232C
- Transmission form : Asynchronous, bi-directional, half duplex
- Transmission rate : 10 times/second or 5 times/second (same as data refresh rate)
- Data format : Baud rate : 600, 1200, 2400, 4800, 9600, 19200 bps
 - Data bits : 7 or 8 bits
 - Parity : Even, Odd (Data bits 7 bits)
 - None (Data bits 8 bits)
- Stop bit : 1 bit
- Code : ASCII

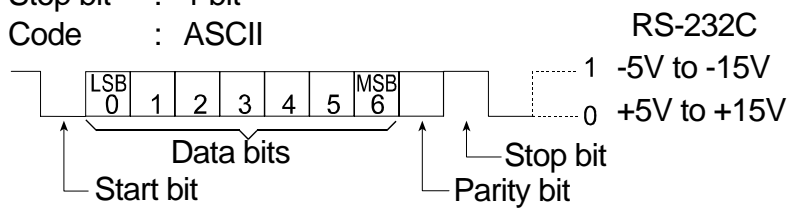

D-Sub 25-pin assignments

Pin No.	Signal name	Direction	Description
1	-	-	No connection
2	TXD	Output	Transmit data
3	RXD	Input	Receive data
4	-	-	No connection
5	SG	-	Signal ground
6	DSR	Output	Data set ready
7	RTS	Input	Request to send
8	CTS	Output	Clear to send
9	-	-	No connection

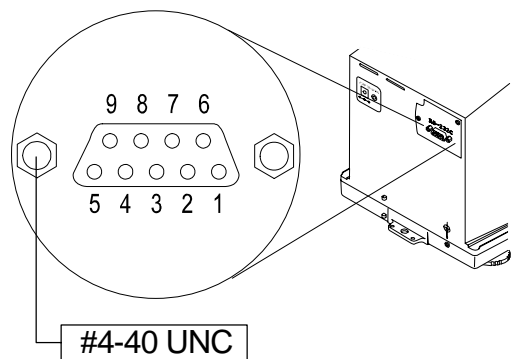

Signal names of the balance side are the same as the DTE side with TXD and RXD reversed.

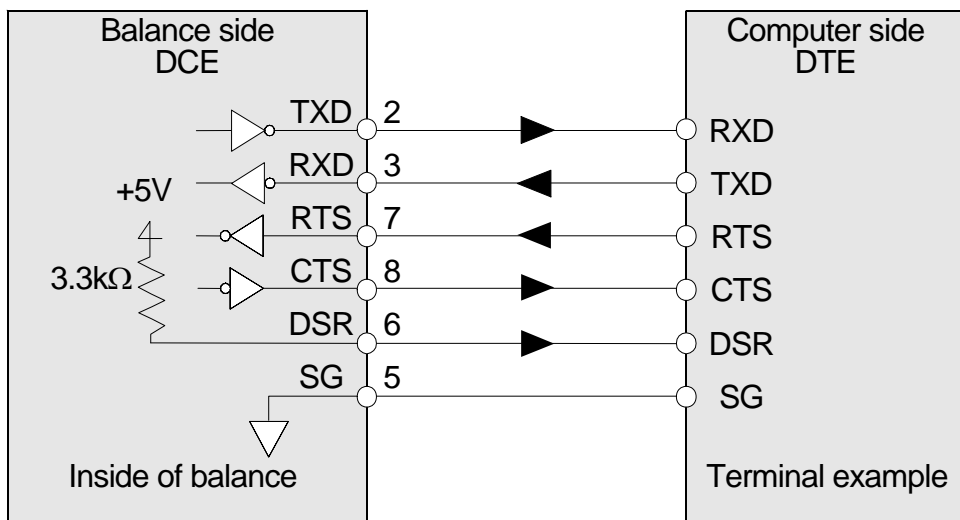

13.2. Connection to Peripheral Equipment

Connection to an AD-8121B printer

Preset the following parameters to use the AD-8121B printer.

Class	Item and Parameter	Factory settings	AD-8121B MODE 1	AD-8121B MODE 2	AD-8121B MODE 3
Data output	Prt Data output mode	0	0, 1, 2	3	0, 1, 2
	$AP-P$ Auto print polarity	0	#1	Not necessary	#1
	$AP-b$ Auto print difference	1			
	$S-ID$ ID number output	0	0	0	0, 1
	$PUSE$ Data output pause	0	0	0	0, 1 #2
	$At-F$ Auto feed	0	0	0	0, 1
Serial interface	bPS Baud rate	2	2	2	2
	$btPr$ Data bit, parity bit	0	0	0	0
	$CrLF$ Terminator	0	0	0	0
	$TYPE$ Data format	0	0	0	1
	CTS CTS, RTS control	0	0	0	0

#1 Set parameters when auto print mode A or B ($Prt = 1$ or 2) is selected.

#2 Set 1 when multiple lines are printed. Example: When adding ID number, set 1.

Notes

- Refer to "11.2. GLP Report" for print samples.
- Settings of AD-8121B
 - MODE 1 .. Print at receiving data.
Standard mode, statistic mode
 - MODE 2 .. Print by DATA key operation or built-in timer.
Standard mode, interval mode, chart mode
 - MODE 3 .. Print at receiving data.
Dump print mode

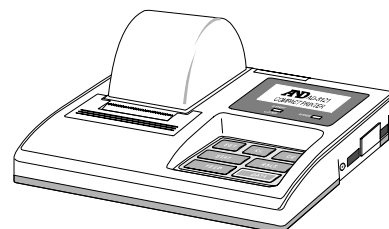

Connection to a computer and the use of WinCT

The balance is of the DCE type (Data Communication Equipment), which can be connected to a personal computer using the RS-232C interface. Before connection, read the personal computer manual thoroughly. Use a standard DCE cable for connection (cable type: straight-through).

Using Windows Communication Tools Software (WinCT)

When Windows is used as an operating system in a personal computer, the provided WinCT software can be used to transmit the weighing data to the personal computer.

The WinCT software has two communication methods: "RsCom" and "RsKey". Refer to the WinCT instruction manual.

The current version of the WinCT can be downloaded from the A&D website.

RsCom

- RsCom can transmit commands to control the balance.
- RsCom can make bi-directional communication between the balance and a personal computer using the RS-232C interface.
- RsCom can display or store the data using a text file format. RsCom can also print the data using a printer connected to the personal computer.
- When several ports of a personal computer have balances connected, the personal computer can communicate with each balance simultaneously.
- RsCom can share a personal computer with other application software.
- RsCom can receive the balance GLP report.

RsKey

- RsKey can transmit the weighing data output from the balance directly to other application software such as Microsoft Excel.
- RsKey can be used with most application software.
- RsKey can receive the balance GLP report.

Using the WinCT software, the balance can do the following:

- **Analyzing the weighing data and the statistics input by "RsKey"**

The weighing data can be input directly into an Excel worksheet. Then, Excel can analyze the data to obtain total, average, standard deviation, maximum and minimum value, and display them in a graph.
- **Controlling the balance using commands from a personal computer**

By using "RsCom", the personal computer sends commands such as "re-zero" or "send weighing data" to the balance and controls the balance.
- **Printing the balance GLP report using your printer**

The balance GLP report can be printed using a printer connected to the personal computer.
- **Receiving weighing data at a certain interval**

The weighing data can be received at a certain interval and data characteristic with elapsed time can be obtained.
- **Using a personal computer as an external indicator**

With the "RsKey" test mode function, a personal computer can be used as an external weight indicator for the balance. (To do this, set the balance data output mode to stream mode.)

13.3. Commands

13.3.1. Command List

Note A command has a terminator added, that is specified using "S iF CrLF" of the function table, and is sent to the balance.

Commands to query weighing data	
C	Cancels the S or SIR command.
Q	Requests the weighing data immediately.
S	Requests the weighing data when stabilized.
SI	Requests the weighing data immediately.
SIR	Requests the weighing data continuously.

Commands to control the balance	
CAL	Same as the <input type="button" value="CAL"/> key.
OFF	Turns the display off.
ON	Turns the display on.
P	Same as the <input type="button" value="ON:OFF"/> key
PRT	Same as the <input type="button" value="PRINT"/> key
R	Same as the <input type="button" value="RE-ZERO"/> key ^(Note 1)
RNG	Same as the <input type="button" value="RANGE"/> key
TR	Tares the balance (Cancels the container's weight.) ^(Note 1)
U	Same as the <input type="button" value="MODE"/> key

Commands to request data	
?ID	Requests the ID number.
?PT	Outputs the tare value. ^(Note 1)
?SN	Requests the serial number of the balance.
?TN	Requests the model name of the balance.

Command to set data	
PT:***.**** <input type="button" value="g"/>	Sets the tare value. ^(Note 1)

- (Note 1)**
- R command assumes the point as zero and sets the display to zero.
 - TR command cancels the tare weight when the displayed value is greater than zero. The canceled tare value can be read using the ?PT command.
 - PT: command sets the tare value digitally.
 - An example of this command sets a negative target value and fills with the sample until the display becomes zero.
 - Step 1 Place a container.
 - Step 2 Set the display to zero using the R command.
 - Step 3 Set a target value using the PT: command.
- For details, refer to page 49

13.3.2. Acknowledge Code and Error Codes

When the "Serial interface function (*S_{IF}*)" parameter is set to "Error", the balance outputs <AK> code or error code to each command as follows:

<AK> (06h) Acknowledge in ASCII code.

- When the balance receives a command to request data and can not process it, the balance transmits an error code (EC, E_{xx}).

When the balance receives a command to request data and can process it, the balance outputs the data.

- When the balance receives a command to control the balance and can not process it, the balance transmits an error code (EC, E_{xx}).

When the balance receives a command to control the balance and can process it, the balance transmits the acknowledge code.

Among commands to control the balance, the following transmit the acknowledge code both when the balance receives the command and when the balance has accomplished the command. If the command can not be processed properly, the balance transmits an error code (EC, E_{xx}). This error can be released using the CAL command.

CAL command (Calibration command)

ON command (Display ON command)

P command (Display ON/OFF command)

R command (RE-ZERO command)

TR command (Tare command)

TST command (Calibration test command)

- When a communication error has occurred due to external noise, or a parity error has occurred due to a transmission error, the balance transmits an error code. In this case, send the command again.

xx is error code number.

13.3.3. Control Using CTS and RTS

Depending on the "CTS" parameter of "Serial interface (*S_{IF}*)", the balance performs as follows:

CTS 0

Regardless of whether the balance can receive a command or not, the balance keeps the CTS line Hi. The balance outputs data regardless of the condition of the RTS line.

CTS 1

The CTS line is kept Hi normally. When the balance can not receive the next command (Example: while the balance is processing the last command), the balance sets the CTS line to Lo. The balance confirms the level of the RTS line before outputting a set of data. If the RTS level is Hi, the balance outputs data. If the RTS level is Lo, data is not output (The data is canceled).

13.3.4. Settings Related to RS-232C

Concerning the RS-232C, the balance has two functions: "Data output (*d_{out}*)" and "Serial interface (*S_{IF}*)". Set each function as necessary.

13.3.5. Command Examples

This example uses the "ErCd I" of "SIF" so that the <AK> (06h) code is output.

ON command (turning on the balance)

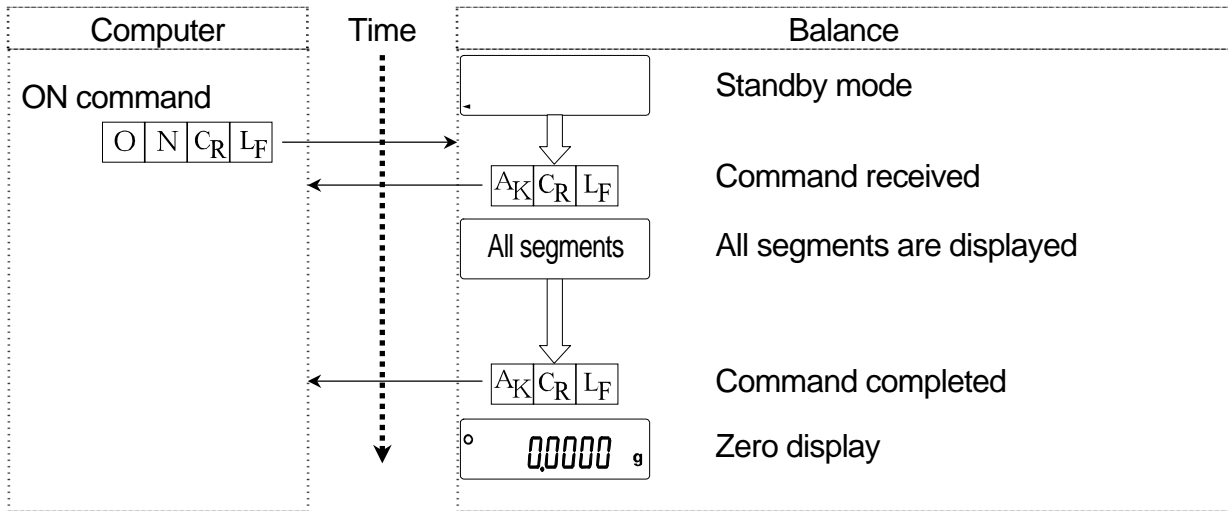

R command (Re-zeroing the display)

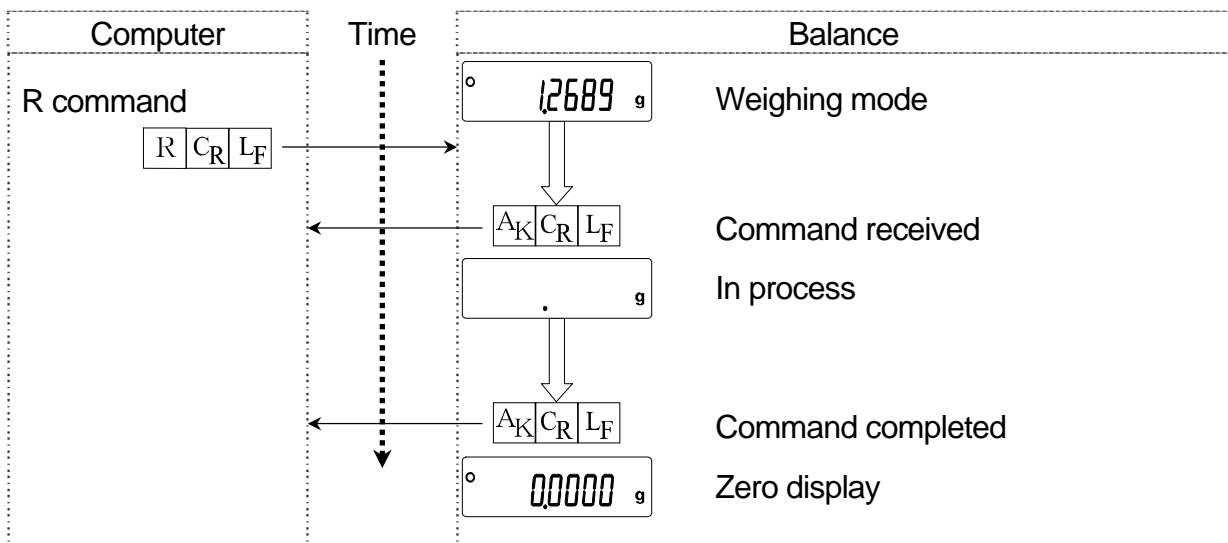

Error code

This example is of an error using the R command. "Error 1" is used. The balance transmits an error code when the received command can not be achieved.

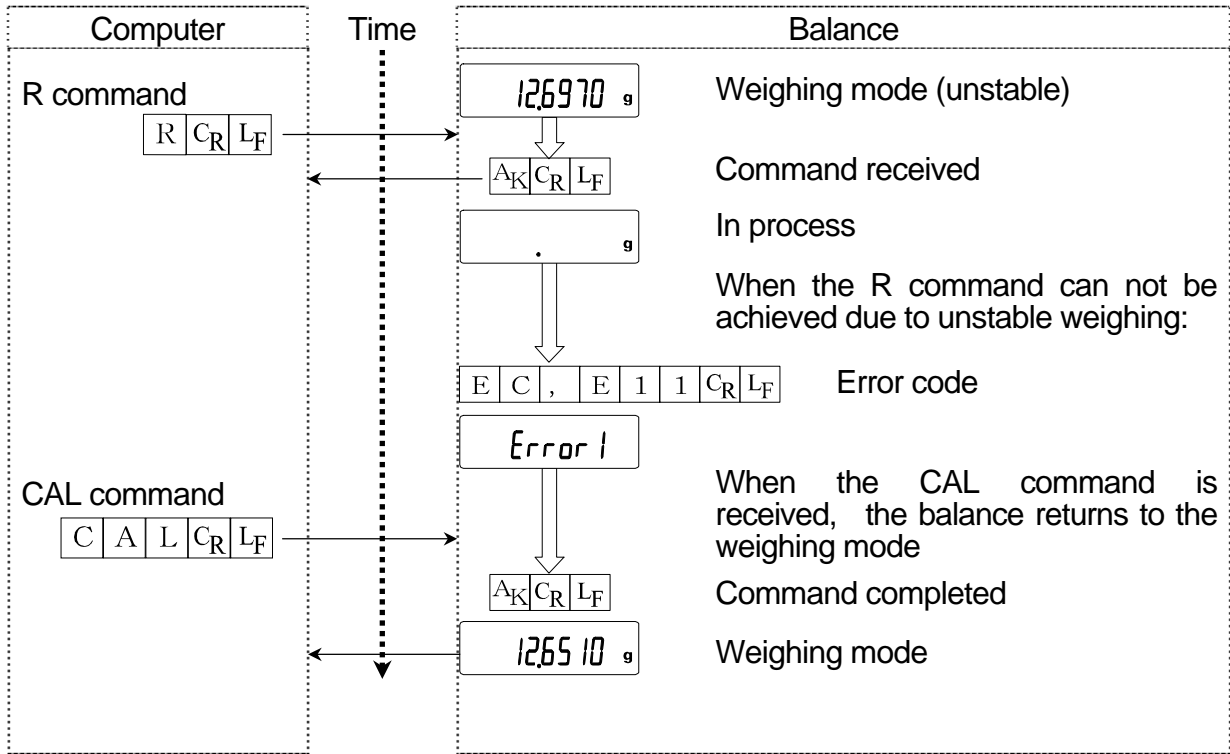

Weighing with a tare

This example uses "ErCd" of "SIF" so that the <AK> (06h) code is output.

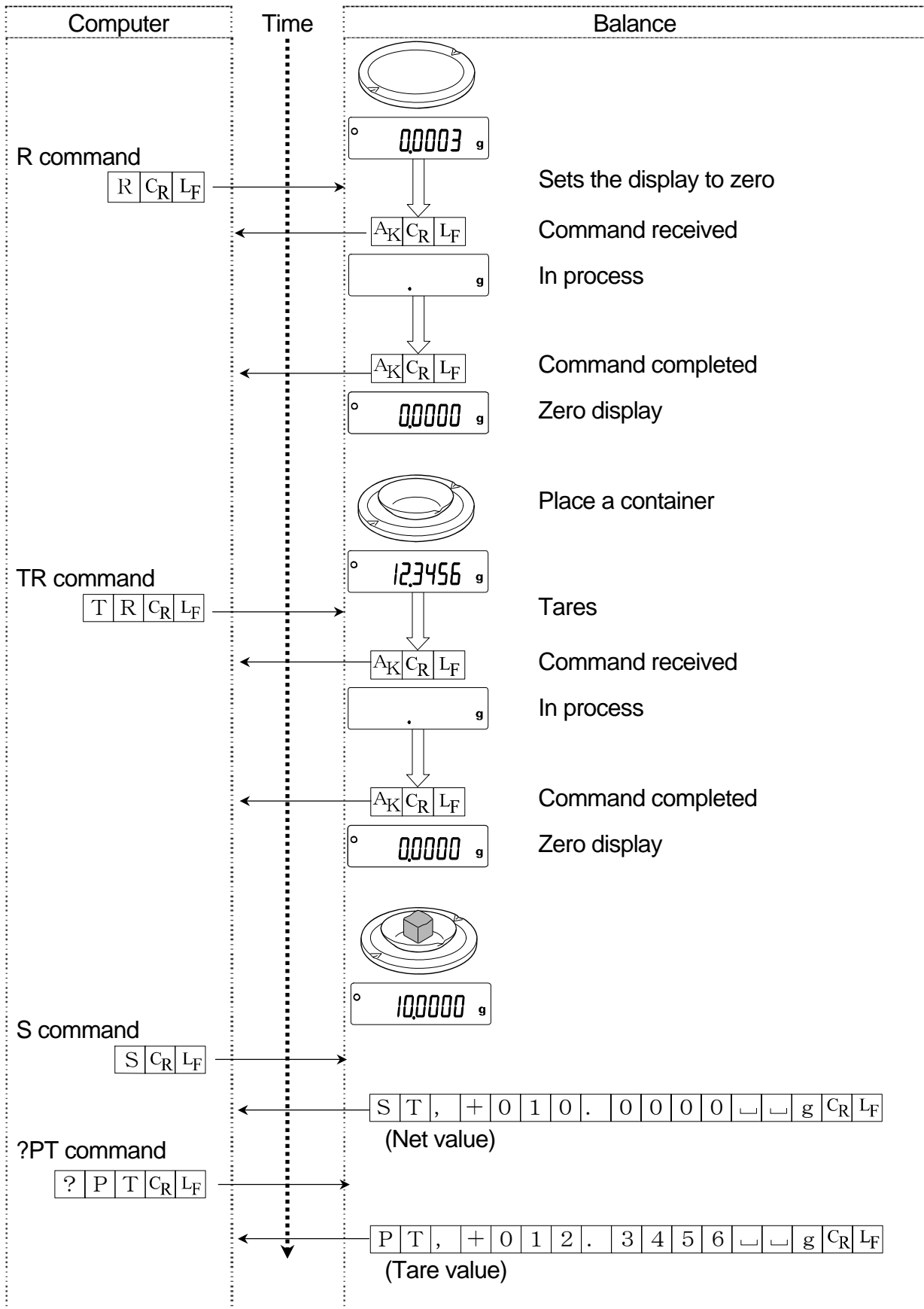

Setting a negative target value and filling with a sample until the display becomes zero

This example uses "ErEd l" of "S iF" so that the <AK> (06h) code is output.

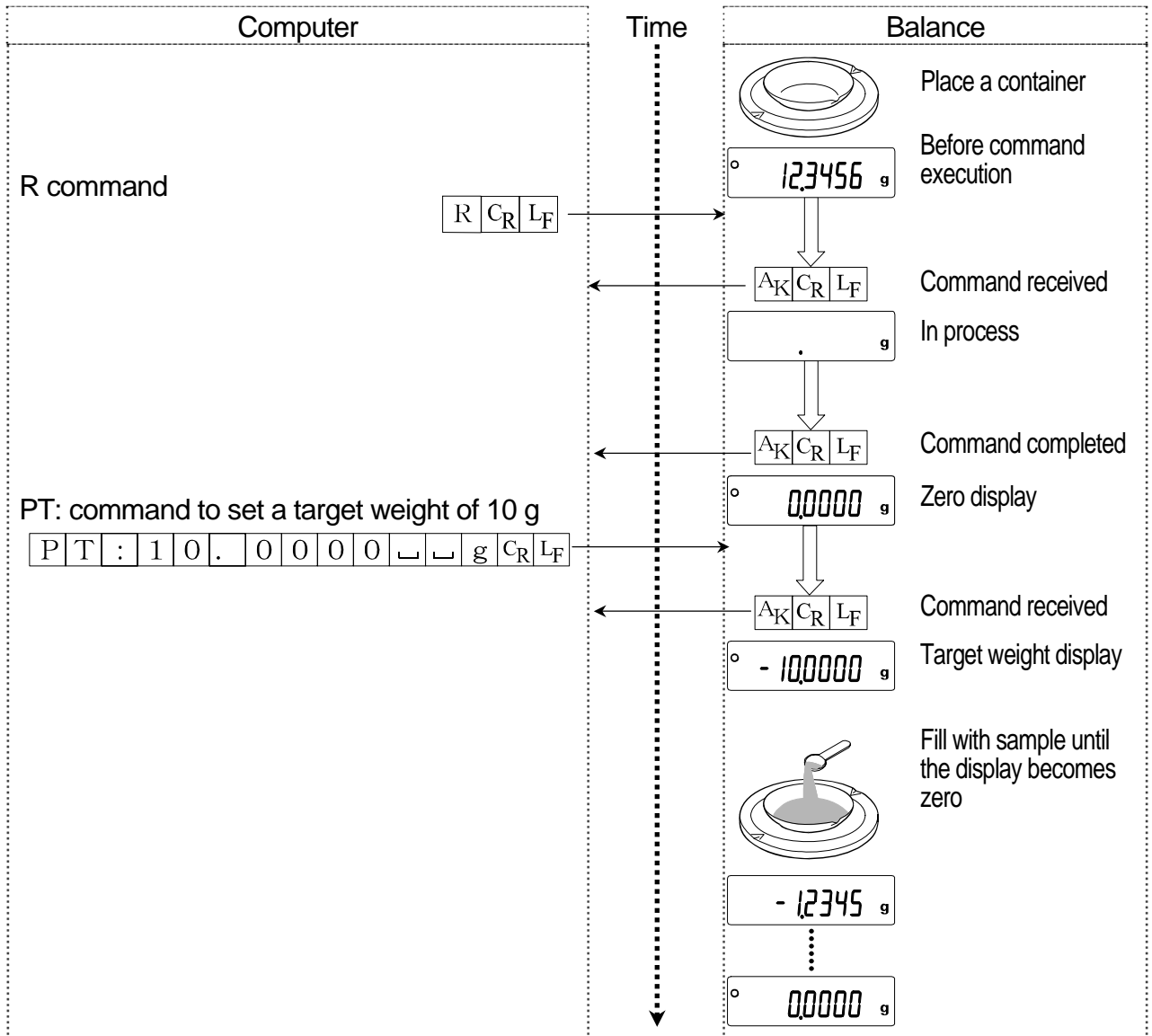



:

14. Maintenance

14.1. Treatment of the Balance

- Clean the balance with a lint free cloth that is moistened with warm water and a mild detergent.
- Do not use organic solvents to clean the balance.
- Do not disassemble the balance. Contact the local A&D dealer if the balance needs service or repair.
- Use the original packing material for transportation.
- Consider section "3. Precautions" for using the balance.

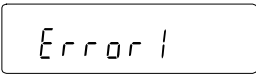
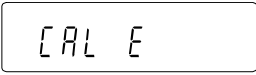
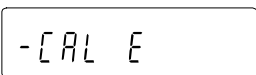
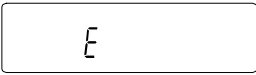
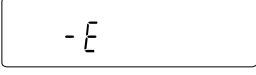
14.2. Error Codes

Display	Error code	Description
	EC,E11	Stability error The balance can not stabilize due to an environmental problem. Check around the pan. Prevent vibration, drafts, temperature changes, static electricity and magnetic fields, from influencing the balance. To return to the weighing mode, press the CAL key.
	EC,E20	Calibration weight error The calibration weight is too heavy. Confirm the calibration weight value. Press the CAL key to return to the weighing mode.
	EC,E21	Calibration weight error The calibration weight is too light. Confirm the calibration weight value. Press the CAL key to return to the weighing mode.
		Overload error A sample beyond the balance weighing capacity has been placed on the pan. Remove the sample from the pan.
		Weighing pan Error The weight value is too light. Confirm that the weighing pan is properly installed and calibrate the balance.
		Sample mass error The balance can not store the sample for the counting mode or for the percent mode because it is too light. Use a larger sample.

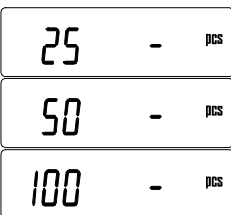
Display	Error code	Description
		Unit mass error The sample unit mass for the counting mode is too light. Storing and using it for counting will cause a counting error. Add samples to reach the specified number and press the PRINT key. Pressing the PRINT key without adding samples will shift the balance to the counting mode. But, for accurate counting, be sure to add samples.
	EC,E00	Communications error A protocol error occurred in communications. Confirm the format, baud rate and parity.
	EC,E01	Undefined command error An undefined command was received. Confirm the command.
	EC,E02	Not ready A received command can not be processed. Example: <ul style="list-style-type: none"> □ The balance received a "Q" command, but not in the weighing mode. □ The balance received a "Q" command while processing a RE-ZERO command. Adjust the delay time to transmit a command.
	EC,E03	Timeout error If the timeout parameter is set to "t-UP 1", the balance did not receive the next character of a command within the time limit of one second. Confirm the communication.
	EC,E04	Excess characters error The balance received excessive characters in a command. Confirm the command.
	EC,E06	Format error A command includes incorrect data. Example: <ul style="list-style-type: none"> □ The data is numerically incorrect. Confirm the command.
	EC,E07	Parameter setting error The received data exceeds the range that the balance can accept. Confirm the parameter range of the command.
Other error code		If an error described above can not be released or other errors are displayed, contact the local A&D dealer.

14.3. Checking the Balance Performance and Environment

The balance is a precision instrument. When the operating environment or the operating method is inadequate, correct weighing can not be performed. Place a sample on the pan and remove it, and repeat this several times. If the balance seems to have a problem with repeatability or to perform improperly, check as described below. If improper performance persists after checking, contact the local A&D dealer for repair.

Checking that the operating environment or weighing method is proper

Operating environment

- Is the weighing table solid enough?
- Is the balance level?
- Is the operating environment free from vibration and drafts?
- Is there a strong electrical or magnetic noise source such as a motor near the balance?

Weighing method

- Does the weighing pan rim touch anything? Is the weighing pan assembly installed correctly?
- Is the **RE-ZERO** key pressed before placing a sample on the weighing pan?
- Is the sample placed in the center of the weighing pan?
- Is the fine range breeze break ring installed for weighing with a minimum display of 0.01 mg for the HR-202i?
- Has the balance been warmed up for one hour before weighing?

Sample and container

- Has the sample absorbed or lost moisture due to the ambient conditions such as temperature and humidity?
- Has the temperature of the container been allowed to equalize to the ambient temperature?
- Is the sample charged with static electricity?
- Is the sample of magnetic material such as iron? There are cautions about weighing magnetic materials.

Checking that the balance performs properly

- Check the balance performance using an external weight. Be sure to place the weight in the center of the weighing pan.
- Check the balance repeatability, linearity and calibrated value using an external weight with a known value.

14.4. Asking for Repair

If the balance needs service or repair, contact the local A&D dealer.

The balance is a precision instrument. Use much care when handling the balance and observe the following when transporting the balance.

- Use the original packing material for transportation.
- Remove the weighing pan, pan support, breeze break ring and dust plate from the main unit.

15. Specifications

	HR-300 <i>i</i>	HR-202 <i>i</i>
Weighing capacity	320 g	220 g
		51 g
Maximum display	320.0084 g	220.0084 g
		51.00009 g
Minimum display	0.1 mg	0.1 mg
		0.01 mg
Repeatability (Standard deviation)	0.2 mg	0.1 mg
		0.02 mg
Linearity	±0.3 mg	±0.2 mg
		±0.03 mg
Stabilization time (Typical at FAST)	Approx. 3.5 seconds	Approx. 3.5 seconds
		Approx. 8 seconds
Sensitivity drift, 10°C to 30°C / 50°F to 86°F	±2 ppm/°C	
Operating environment	5°C to 40°C (41°F to 104°F), 85%RH or less (No condensation)	
Display refresh rate	5 times/second or 10 times/second	
Counting mode	Minimum unit mass	0.1 mg
	Number of samples	10, 25, 50 or 100 pieces
Percent mode	Minimum 100% reference mass	10.0 mg
	Minimum 100% display	0.01 %, 0.1 %, 1 % (Depends on the reference mass stored.)
Interface	RS-232C with Windows Communication Tools Software (WinCT)	
External calibration weight	300g 200g 100g	200g 100g 50g 20g
Weighing pan	φ90 mm	
External dimensions	217(W) x 442(D) x 316(H) mm	
Power supply & AC adapter type	Power consumption: Approx. 11VA (supplied to the AC adapter) Confirm that the adapter type is correct for the local voltage and power receptacle type.	
Mass	Approx. 7.9 kg	

- The operating environment does not include excessive change of ambient temperature, humidity, vibration, drafts, magnetic fields and static electricity.
- The mass value of the weight may change due to corrosion or other damage caused by the operating environment, or due to aging. Correct the mass value periodically if necessary.

15.1. External Dimensions

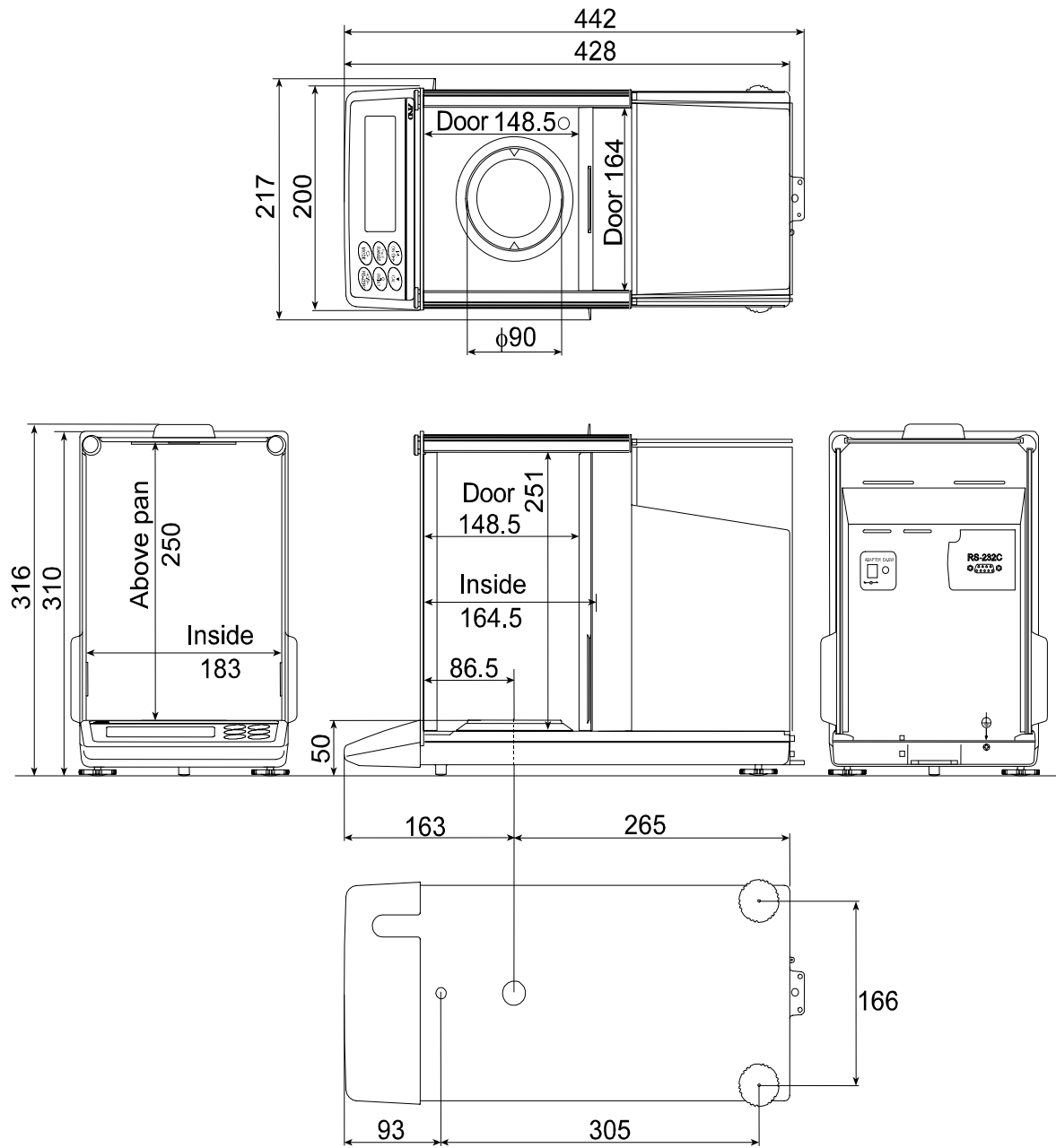

Unit: mm

15.2. Options and Peripheral Instruments

AD-8121B Printer

- Compact dot-matrix printer
- Statistical function, clock and calendar function, interval print function, graphic print function, dump print mode
- 5 x 7 dots, 16 characters per line
- Print paper (AX-PP143, 45 (W) x 50 (L) mm , ø65 mm)
- AC adapter or alkaline battery

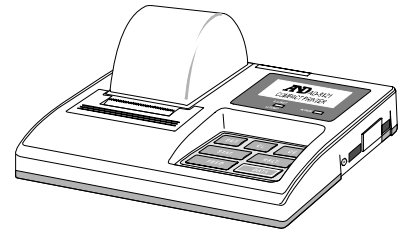

AD-1653 Density Determination Kit

$$\frac{\text{Weigh in air}}{\text{Weigh in water} - \text{Weigh in the air}} \times \text{water density} = \text{sample density}$$

Example

$$\frac{10.0000 \text{ g}}{10.0000 \text{ g} - 9.5334} \times 0.9970 \text{ g/cm}^3 = 21.4 \text{ g/cm}^3$$

Temperature	Water density
0°C	0.99984 g/cm ³
10°C	0.99970 g/cm ³
20°C	0.99820 g/cm ³
30°C	0.99565 g/cm ³

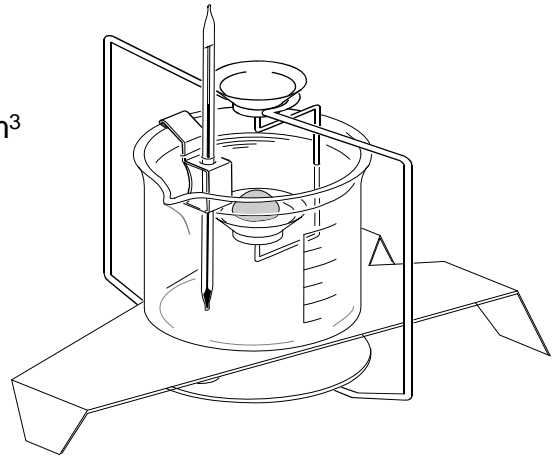

AD-1683 DC Static Eliminator

- A compact design with efficient static elimination
- No air blowing from a fan allows precision weighing
- Used to eliminate the static electricity from the weighing material

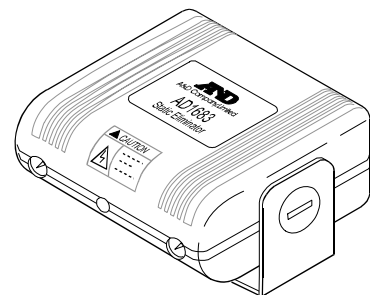

AX-USB-9P-EX USB Converter

- Adds a COM port to a PC.
- Enables bi-directional communication between the PC and the balance when a USB driver is installed.
- Can use serial communication software such as WinCT on a PC without COM ports.
- An RS-232C cable is provided to connect the USB converter to the balance.

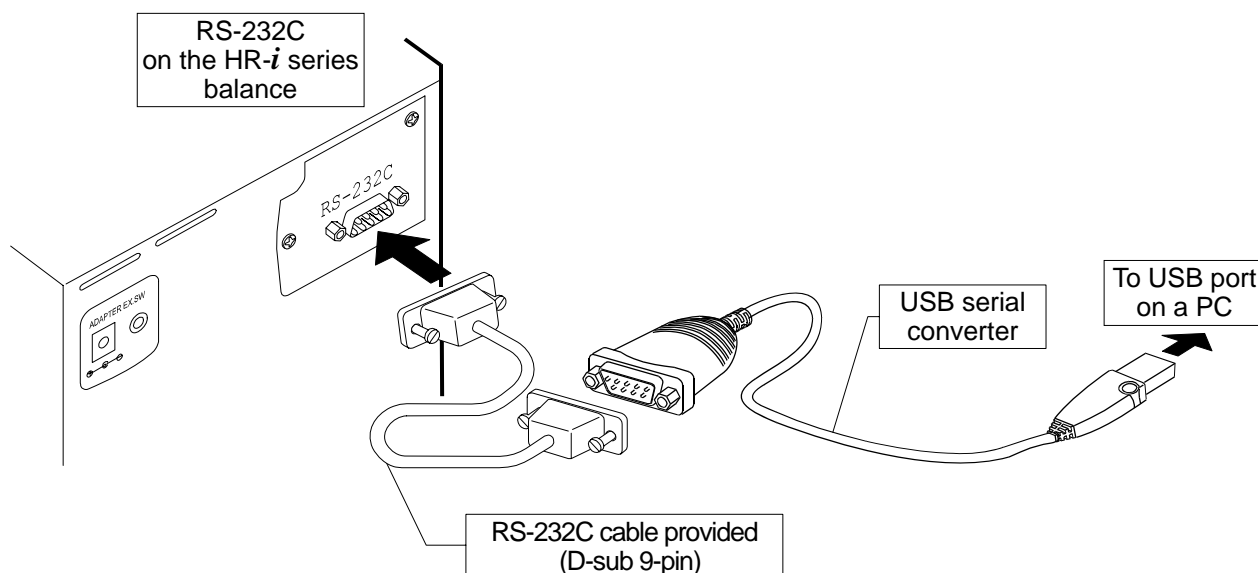

AX-T-314A-S External Key Plug

This plug produces the same operations as pressing the **RE-ZERO** and **PRINT** keys. It enables remote control of the balance using an external key.

To use the plug, the GND line must be connected to the PRINT or RE-ZERO line for at least 100 milliseconds.

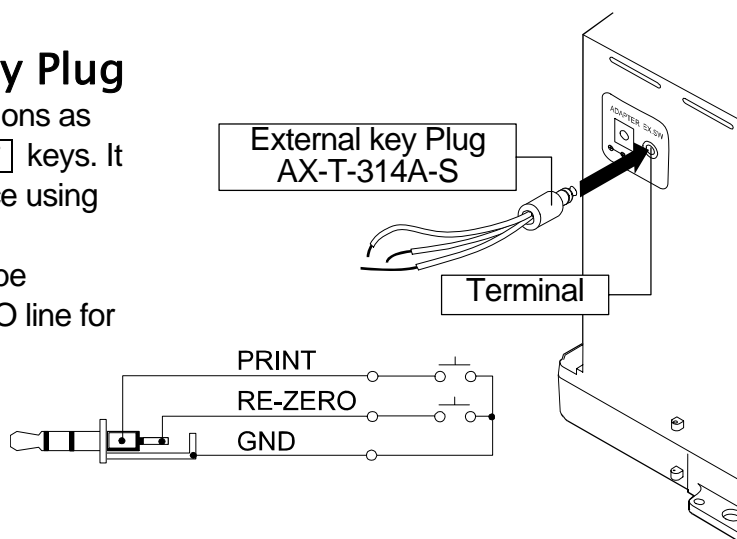

AX-SW128 Foot Switch

When connected to the external key plug, the switch can be used as the **RE-ZERO** or **PRINT** keys.

Note Before using the foot switch, connect AX-SW128 and AX-T-314A-S.

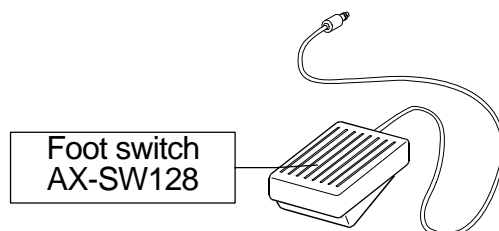

Other accessories











Order code	Name and description
AD-1682	<p>Rechargeable Battery</p> <ul style="list-style-type: none"> □ This option allows use of the balance in a place where AC power is not available.
AD-1684	<p>Electrostatic field meter</p> <ul style="list-style-type: none"> □ This option measures the amount of the static charge on the sample, tare or peripheral equipment and displays the result. If those are found to be charged, discharge them using the AD-1683 DC static eliminator.
AD-1685	<p>Anti-vibration table</p> <ul style="list-style-type: none"> □ This option can be used when the balance has difficulty stabilizing, due to vibration coming from the floor. As the table has a high vibration absorbing property, key operations on the balance may make the top of the table tilt slightly, causing a weighing error. To avoid this, use the AD-8922 remote controller to control the balance.
AD-1689	<p>Tweezers for calibration weight</p> <ul style="list-style-type: none"> □ This option is used when calibrating the balance using an external weight.
AD-8526	<p>LAN Converter</p> <ul style="list-style-type: none"> □ This option can be used to connect the RS-232C interface of the balance to the Ethernet (LAN) port of a computer. This allows management of the balance weighing data with a computer connected to a network.
AD-8920	<p>Remote Display</p> <ul style="list-style-type: none"> □ This option can be connected to the balance using the RS-232C interface.
AD-8922	<p>Remote Controller</p> <ul style="list-style-type: none"> □ This option can be connected to the balance using the RS-232C interface and can control the balance remotely. □ Various options such as comparator output or analog output are available.

16. Terms/Index

16.1. Terms

Calibration	Adjustment of the balance so that it can weigh accurately.
Calibration weight	A weight used for calibration
Data number	Numbers assigned sequentially when weighing data or unit weight is stored.
Digit	The minimum weighing value available. Used for the balance, one digit is the smallest mass that can be displayed.
Environment	Ambient conditions such as vibration, drafts, temperature, static electricity and magnetic fields which affect the weighing operation.
External weight	The weight that you have.
GLP	Good Laboratory Practice.
GMP	Good Manufacturing Practice
ISO	International Organization for Standardization
Repeatability	Variation in measured values obtained when the same mass is placed and removed repetitively. Usually expressed as a standard deviation. Example: Standard deviation = 1 digit: This means that measured values, obtained when the same sample is placed and removed repetitively, fall within ± 1 digit in the frequency of about 68%.
Re-zero	To set the display to zero.
Sensitivity drift	An affect that a change in temperature causes to the weighing data. Expressed as a temperature coefficient. Example: Temperature coefficient = 2 ppm/ $^{\circ}\text{C}$: If a load is 10 g and the temperature changes by 10°C , the value displayed changes by the following value. $0.0002\%/^{\circ}\text{C} \times 10^{\circ}\text{C} \times 10\text{g} = 0.0002 \text{ g}$
Stabilization time	Time required after a sample being placed, until the stabilization indicator illuminates and the weighing data is displayed.
Tare	To cancel the weight of a container which is not to be included in the weighing data. Normally, refers to an operation of placing a container and setting the display to zero.
Target mass	An external weight used for calibration test
Zero point	A weighing reference point. Usually refers to the value displayed when nothing is on the weighing pan.

16.2. Index

- % Unit of percent mode 18
-  CAL key..... 10, 25
-  MODE key 10
-  ON/OFF key..... 10
-  PRINT key..... 10, 25
-  RANGE key 10, 25
-  RE-ZERO key 10, 25
-  Process indicator 10
-  Standby indicator 10
-  Space mark..... 34, 37, 38, 39
-  Stabilization indicator 10, 14, 25
-  **RESPONSE** FAST MID SLOW Response indicator 10

- A&D format 32
- AC adapter 6, 53
- ACAI Function..... 17
- Accessory 57
- AD-1653 Density determination kit 55
- AD-1682 Rechargeable battery 57
- AD-1683 DC static eliminator..... 55
- AD-1684 Electrostatic field meter 57
- AD-1685 Anti-vibration table 57
- AD-1689 Tweezers for calibration weight 57
- AD-8121B Printer..... 55
- AD-8526 LAN converter..... 57
- AD-8920 Remote display 57
- AD-8922 Remote controller 57
- AK code 45
- AP-b* Auto print difference 28, 31, 42
- AP-d* Zero after output 28
- AP-P* Auto print polarity..... 28, 31, 42
- AF-F* Auto feed..... 28, 42
- AX-SW128 Foot switch..... 56
- AX-T-314A-S External key plug 56
- AX-USB-9P-EX USB converter 56
- bASFnC* Environment display 25, 28
- bPS* Baud rate 29, 42
- bEP* Data bit, parity bit 29, 42
- CAL E* Calibration weight error..... 50
- CAL E* Calibration weight error..... 50
- CAL out* Calibration using an external weight .. 21
- Calibration 22, 58
- CE out* Calibration test 22
- Cond* Condition..... 19, 28, 30
- CrLF* Terminator 29, 42
- CSV format 34
- CTS* CTS, RTS control..... 29, 42
- CTS 45
- Data number 58
- Digit 58
- dout* Data output..... 28, 31
- Dump print 32
- E* Weighing pan Error 50
- E* Overload error 50
- EC,E00 Communications error 51
- EC,E01 Undefined command error..... 51
- EC,E02 Not ready..... 51
- EC,E03 Timeout error..... 51
- EC,E04 Excess characters error..... 51
- EC,E06 Format error 51
- EC,E07 Parameter setting error..... 51
- EC,E11 Stability error 50
- EC,E20 Internal mass error..... 50
- EC,E21 Internal mass error..... 50
- ErEd* AK, Error code 29
- Error 1* Stability error 50
- Error code 50
- External weight..... 20, 58
- FAST 19
- FCC 4
- GLP 58
- GMP 58
- id* ID number setting..... 29
- ID Number 33, 36
- info* GLP output..... 28
- KF format 32
- Lo* Sample mass error 50
- MID. 19
- MT format 33
- Numerical format..... 33
- Pnt* Decimal point 28, 30
- P-on* Auto display-ON..... 28, 30
- Prt* Data output mode 28, 31, 42
- PUSE* Data output pause..... 28, 42
- rEcEnd* End block 39
- Repeatability 53, 58
- Re-zero 58
- RsCom 43
- RsKey 43
- RTS 45
- S-id* ID number output 28, 42
- SIF* Serial interface 29
- SLOW 19
- SPd* Display refresh rate..... 28, 30
- Stabilization time 53, 58
- StAr* Title block 39
- St-b* Stability band width 28, 30
- Tare 14, 58
- Target mass 58
- trc* Zero tracking 28, 30
- t-UP* Timeout 29
- tYPE* Data format 29, 42
- PCS Unit of counting mode..... 16
- Unit 10, 11, 35
- Unit* Unit..... 29
- WinCT Communication Tools 43
- Zero point 58

