



Laboratory Refrigerators and Freezers

- ▶ Refrigerators and Upright Freezers
- ▶ Bloodbank Refrigerators and Freezers
- ▶ Chest Freezers
- ▶ Temperature Monitoring and Recording Systems
- ▶ Recirculating Chillers

2019

www.NationalLab.com

National Lab GmbH • Grambeker Weg 157 • D-23879 Moelln
Tel: +49 45 42/84 91-70 • Fax: +49 45 42/84 91-71 • E-mail: LabSales@NationalLab.com

Laboratory Refrigerators and Freezers

A

Laboratory Refrigerators and Upright Freezers

-86 °C to +10 °C / 7 litres to 1380 litres

B

Bloodbank Refrigerators, Plasma Storage Cabinets

Bloodbank: +2 °C to +6 °C / 100 litres to 1255 litres

Plasma: -14 °C to -45 °C / 70 litres to 241 litres

C

Refrigerator/Freezer Combinations

Refrigerator: +1 °C to +10 °C / 77 litres to 290 litres

Freezer: -10 °C to -30 °C / 6,5 litres to 290 litres

D

Laboratory Chest Freezers

-5 °C to -86 °C / 8 litres to 701 litres

E

Temperature Monitoring and Recording Systems

-110 °C to +600 °C

F

Laboratory Recirculating Chillers, Water-to-Water Heat Exchanger

310 W to 15.6 kW

Annex: Selection from Catalogue "Inventory Systems"

Interesting Links:

www.Kryobox.de

www.Probenaufbewahrung.de

www.Proficool.de

www.NationalLab.eu

www.Weinkuehlung.org

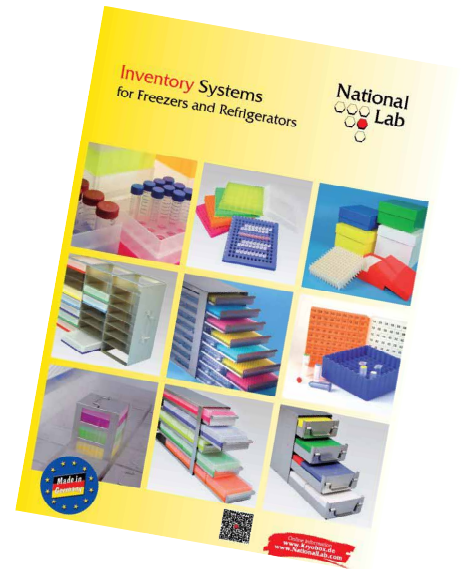

Matching storage systems can be found in our catalogue "Inventory Systems for Freezers and Refrigerators".



www.NationalLab.com

Tel.: +49 45 42 / 84 91 - 70
 Fax: +49 45 42 / 84 91 - 71
 e-Mail: LabSales@NationalLab.com

National Lab GmbH
 Grambeker Weg 157
 D-23879 Moelln



Reg. KAT-LAB-GE-150615

All rights and changes reserved.

© 2015 Copyright by National Lab
 Printed in Germany.

Laboratory Upright Freezer ProfiLine Pegasus PLPE

- Static cooling and manual defrost
- Micro-processor driven temperature controller with digital display and password protection
 - Visual/audible alarm device, mains-independent
 - Alarm warning for excess and insufficient temperature
 - Power failure alarm
 - Probe failure alarm
 - Temperature controller failure alarm
 - Door alarm
 - Integrated data logger with USB port
- No-volt remote alarm contact for connection to an alarm system on the premises
- RS 485 port
- Prepared for GSM alarm
- External housing made of white, galvanized steel plate, optional made of stainless steel (CNS)
- Lockable door, door hinges on right
- Insulated inner doors to minimize cold air loss
- Interior made of stainless steel CNS
- Height adjustable feet



ProfiLine Pegasus PLPE 0186EWN
(With accessories Inventory Systems. See sep. brochure.)

Model ProfiLine Pegasus PLPE 0186EWN

Temperature range	°C:	-40/-86
Content	litres (gross):	7
Ext. dimensions (WxDxH)	mm:	400x630x665
Int. dimensions (WxDxH)	mm:	150x143x310
Depth with door opened	mm:	960
Weight	kgs:	54
Mains connection	:	1/N/PE ~ 230 V 50-60 Hz
Shipping dimensions (WxDxH)	mm:	500x820x860
Shipping weight	kgs:	69
Refrigerant CFC- and HCFC-free	:	EP88



ProfiLine Pegasus + Accessories:	Outside / Inside	Cat. No.
ProfiLine Pegasus PLPE 0186EWN	white / CNS	GSPLPE0186EWN

ProfiTec Temperature Monitoring and Recording System (see sep. brochure).	GPTEC4A
ProfiCaller telephone dialler (see sep. brochure).	on request
Pt-100 temperature sensor, add. installed for ext. temperature recording.	ZXX2-020-2L
CO ₂ back-up system, free-standing.	ZXX2-093
Facilities for customer connection of CO ₂ back-up system.	ZPLPE2-094
MIN/MAX digital thermometer. Hand-held unit with digital display as well as data-hold and relative measuring function. Measuring range -200/+1370 °C. An add. temperature sensor is required, eg. Cat.-No. ZXX2-022-100.	ZXX2-019-011
Temperature sensor for MIN/MAX thermometer ZXX2-019-011.	ZXX2-022-100
Measuring range -100/+1000 °C. Length 2 m. Other ranges on request.	

Innovation prize

ProfiTec Intelligent Temperature Monitoring and Recording System



- For up to 4 refrigerators and/or freezers
- Readings are stored over a period up to 781 days
- Warning for excess and insufficient temperature
- Includes No-volt remote alarm contact
- The measuring protocol can be fed to PC via RS 232 port

Storage system alternatives with boxes up to external dimensions (WxD) 136x136 mm.

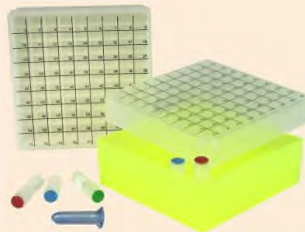

Plastic boxes made of Polypropylene



Boxes and grid dividers made of fiberboard

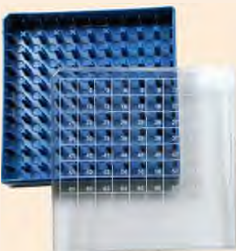

Plastic boxes made of Polycarbonate



Plastic boxes made of Polypropylene



Please ask for a personal fitting option.

Recommendations for additional storage sets can be found in our separate catalogue.

Laboratory Upright Freezer ProfiLine Pegasus PLPE

- Static cooling and manual defrost
- Most reliable and less complicated compressor technology from Danfoss
- Electronic control with digital display
 - Visual/audible alarm device
 - Power failure alarm
- No-volt remote alarm contact for connection to an alarm system on the premises
- Rechargeable battery for full retention of all controller features
- Lockable door, door hinges on right
- Interior made of stainless steel CNS (hygienic and easy to clean)
- Duct to storage compartment



ProfiLine Pegasus PLPE 0486
(With accessories Inventory Systems.
See sep. brochure.)

Model ProfiLine Pegasus PLPE 0486

Temperature range	°C:	-60/-80
Content litres	litres (gross):	35
Ext. dimensions (WxDxH)	mm:	490x650x670
Int. dimensions (WxDxH)	mm:	330x355x300
Depth with door opened	mm:	1070
Weight	kgs:	60
Mains connection	:	1/N/PE ~ 230 V 50-60 Hz
Shipping dimensions (WxDxH)	mm:	800x600x875
Shipping weight	kgs:	80
Refrigerant CFC- and HCFC-free	:	EP88

Alternative units: ProfiMaster PMU0452.

ProfiLine Pegasus + Accessories:

	Cat. No.
ProfiLine Pegasus PLPE 0486	GSPLPE0486
ProfiTec Temperature Monitoring and Recording System (see sep. brochure).	GPTEC4A
ProfiCaller telephone dialler (see sep. brochure).	on request
Temperature recorder, 7 days, circular chart.	on request
Pt-100 temperature sensor, add. installed for ext. temperature recording.	ZXX2-020-2L
CO ₂ back-up system, free-standing.	ZXX2-093
Facilities for customer connection of CO ₂ back-up system.	ZPLPE2-094
Storage set (see below).	on request
Stainless steel insert with drawers (see below).	see table
MIN/MAX digital thermometer. Hand-held unit with digital display as well as data-hold and relative measuring function. Measuring range -200/+1370 °C.	ZXX2-019-011
An add. temperature sensor is required, eg. Cat.-No. ZXX2-022-100.	
Temperature sensor for MIN/MAX thermometer ZXX2-019-011.	ZXX2-022-100
Measuring range -100/+1000 °C. Length 2 m. Other ranges on request.	

ProfiTec Intelligent Temperature Monitoring and Recording System



- For up to 4 refrigerators and/or freezers
- Readings are stored over a period up to 781 days
- Warning for excess and insufficient temperature
- Includes No-volt remote alarm contact
- The measuring protocol can be fed to PC via RS 232 port

Storage System alternatives

Storage Set (modifiable)

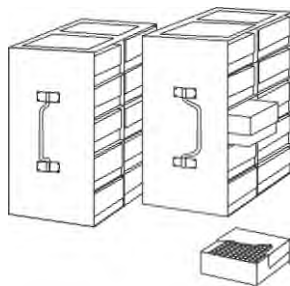

Stainless Steel Insert with 3 Drawers (modifiable)

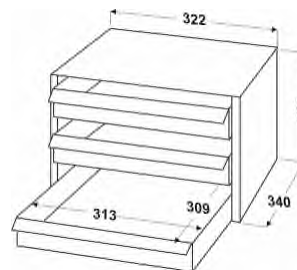

Drawers	Height (mm)	Cat. No.
2	140	ZPLPE3-002
3	91	ZPLPE3-003
4	67	ZPLPE3-004
5	52	ZPLPE3-005
6	43	ZPLPE3-006
7	36	ZPLPE3-007
8	31	ZPLPE3-008
9	27	ZPLPE3-009
10	24	ZPLPE3-010

Height= Effective internal height of each drawer

Recommendations for additional storage sets can be found in our separate catalogue.

Please ask for a personal fitting option.



Laboratory Upright Freezer ProfiLine Pegasus PLPE

- Static cooling and manual defrost
- Micro-processor driven temperature controller with digital display and password protection
 - Visual/audible alarm device, mains-independent
 - Alarm warning for excess and insufficient temperature
 - Power failure alarm
 - Probe failure alarm
 - Door alarm
 - Integrated data logger with USB port
- No-volt remote alarm contact for connection to an alarm system on the premises
- RS 485 port
- Prepared for GSM alarm
- External housing made of white, galvanized steel plate
- Lockable door, door hinges on right
- Insulated inner doors to minimize cold air loss
- Interior made of stainless steel CNS
- Duct to storage compartment
- front feet of cabinet allow for height adjustment, two castors at rear



ProfiLine Pegasus PLPE 06xxEWN

Model ProfiLine Pegasus PLPE0640 PLPE0686 PLPE1240 PLPE1286

Temperature range	°C:	-20/-40	-40/-86	-20/-40	-40/-86
Content litres	litres (gross):	55		115	
Ext. dimensions (WxDxH)	mm:	600x700x815		950x725x810	
Int. dimensions (WxDxH)	mm:	360x505x310		360x493x530	
Compartments/inner doors	:	1/1		2/2 (2x260 mm in height)	
Depth with door opened	mm:	1200		1225	
Weight	kgs:	80		100	
Mains connection	:	1/N/PE ~ 230 V 50-60 Hz		1/N/PE ~ 230 V 50-60 Hz	
Shipping dimensions (WxDxH)	mm:	660x800x1000*		1010x800x1000*	
Shipping weight	kgs:	100*		130*	
Refrigerant CFC- and HCFC-free	:	R404A	EP88	R404A	EP88



ProfiLine Pegasus PLPE 12xxEWN

* Shipping in a wooden crate.

Model	Outside/Inside	Cat. No.
PLPE0640...	EWN: white/CNS	GSPLPE0640EWN
PLPE0686...	EWN: white/CNS	GSPLPE0686EWN
PLPE1240...	EWN: white/CNS	GSPLPE1240EWN
PLPE1286...	EWN: white/CNS	GSPLPE1286EWN

ProfiTec Temperature Monitoring and Recording System (see sep. brochure). GPTEC4A
 ProfiCaller telephone dialler (see sep. brochure). on request
 Pt-100 temperature sensor, add. installed for ext. temperature recording. ZXX2-020-2L
 CO₂ back-up system, free-standing. ZXX2-093
 Facilities for customer connection of CO₂ back-up system. ZPLPE2-094
 MIN/MAX digital thermometer. Hand-held unit with digital display as well as ZXX2-019-011
 data-hold and relative measuring function. Measuring range -200/+1370 °C.
 An add. temperature sensor is required, eg. Cat.-No. ZXX2-022-100.
 Temperature sensor for MIN/MAX thermometer ZXX2-019-011. ZXX2-022-100
 Measuring range -100/+1000 °C. Length 2 m. Other ranges on request.

ProfiTec Intelligent Temperature Monitoring and Recording System



- For up to 4 refrigerators and/or freezers
- Readings are stored over a period up to 781 days
- Warning for excess and insufficient temperature
- Includes No-volt remote alarm contact
- The measuring protocol can be fed

to PC via RS 232 port

Storage System Alternatives



Stainless steel horizontal racks

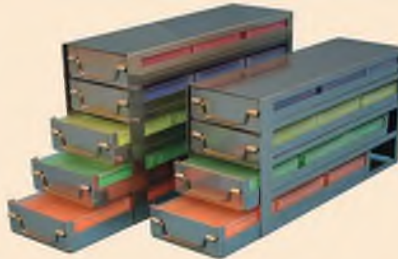

Stainless steel drawer racks



Microtiter stainless steel drawer racks

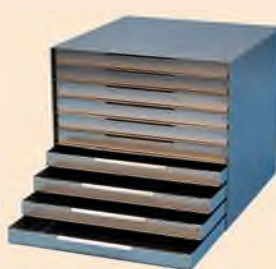

Stainless steel insert with drawers



Please ask for a personal fitting option.

Recommendations for additional storage sets can be found in our separate catalogue.

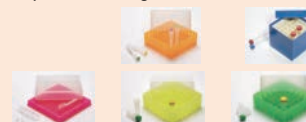

Laboratory Upright Freezer ProfiMaster PMU

- Alternatively with forced air circulation or static cooling
- Micro-processor driven temperature controller with digital display
 - Alarm device with independent circuit, visual/audible
 - No-volt remote alarm contact for connection to an alarm system on the premises
 - RS 485 port
- Exterior case contains stainless steel (CNS)
- Door lockable, door hinges on right
- Interior made of stainless steel (CNS)
- 1 height adjustable shelf
- Duct to storage compartment
- Height adjustable feet



ProfiMaster PMU0452EEN

Model ProfiMaster	PMU0452EEU	PMU0452EEN
Temperature range	°C: -10/-45	-10/-45
	: Other temperature ranges available on request.	
	: Forced air circulation	Static cooling
Content	litres (gross): 43	54
Ext. dimensions (WxDxH)	mm: 720x805x670	720x805x670
Int. dimensions (WxDxH)	mm: 480x275x330	480x340x330
Weight	kgs: 68	65
Mains connection	: 1/N/PE ~ 230 V 50 Hz	1/N/PE ~ 230 V 50 Hz
Shipping dimensions (WxDxH)	mm: 820x905x770	820x905x770
Shipping weight	kgs: 77	74
Refrigerant CFC- and HCFC-free	: R507	R507

ProfiMaster + Accessories	Outside / Inside	Cat. No.
ProfiMaster PMU0452EEU	CNS / CNS	GSPMU0452EEU
ProfiMaster PMU0452EEN	CNS / CNS	GSPMU0452EEN

ProfiTec Temperature Monitoring and Recording System	Cat. No.
ProfiTec Temperature Monitoring and Recording System (see sep. brochure).	GPTEC4A
ProfiCaller telephone dialler (see sep. brochure).	on request
Pt-100 temperature sensor, add. installed for ext. temperature recording.	ZPM2-023-2L
Shelf 440x248 mm (WxD) for PMU0452EEU in the fan area.	ZPMU4-440x248
Shelf 440x310 mm (WxD).	ZPMU4-440x310
Angular guide rails for shelf (1 pair).	ZPMU4-024
Stainless steel insert with drawers (see below). Boxes optional.	on request
Stainless steel horizontal racks.	on request
MIN/MAX thermometer to be placed in refrigerators or freezers.	ZXX2-019-001
Measuring range -50/+50 °C, an add. temperature sensor is not required.	
MIN/MAX digital thermometer. Hand-held unit with digital display as well as data-hold and relative measuring function. Measuring range -200/+1370 °C.	ZXX2-019-011
An add. temperature sensor is required, eg. Cat.-No. ZXX2-022-100.	
Temperature sensor for MIN/MAX thermometer ZXX2-019-011.	ZXX2-022-100
Measuring range -100/+1000 °C. Length 2 m. Other ranges on request.	

Innovation prize

ProfiTec Intelligent Temperature Monitoring and Recording System



- For up to 4 refrigerators and/or freezers
- Readings are stored over a period up to 781 days
- Warning for excess and insufficient temperature
- Includes No-volt remote alarm contact
- The measuring protocol can be fed to PC via RS 232 port

Please ask for a personal fitting option.

Recommendations for additional storage sets can be found in our separate catalogue.

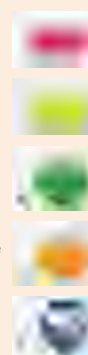

Storage System Alternatives

Stainless steel horizontal racks (modifiable)

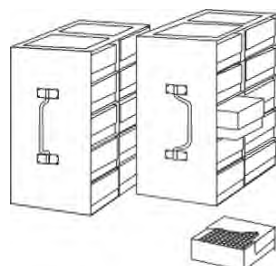

Stainless steel insert with drawers (modifiable)

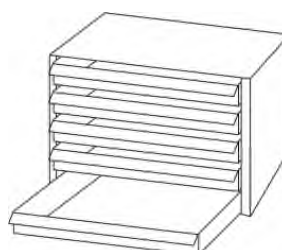

Laboratory Refrigerator LabStar Sanguis LSSA

- Alternatively with forced air circulation or static cooling, automatic defrost and condensate evaporation
- Micro-processor driven temperature controller
 - Visual/audible alarm device
 - Alarm warning for excess and insufficient temperature
 - Probe failure alarm
 - Door alarm
 - Integrated data logger
 - USB port for data download
- No-volt remote alarm contact for connection to a remote alarm system
- External housing made of white corrosion-resistant, galvanized steel plate with PVC finish
- Self-closing and lockable door
- Door hinges on right, changeable
- Door seal changeable
- 2 height adjustable shelves in tilt-resistant guide rails, made of stainless steel CNS
- Interior made of stainless steel CNS
- 4 castors, 2 height adjustable feet at rear



LabStar Sanguis LSSA1105EWU

Model LabStar Sanguis	LSSA1105EWU	LSSA1105GEWU	LSSA1105EWN
-----------------------	-------------	--------------	-------------

Glass door

Temperature range	°C: +2/+12	+2/+12	+2/+12
	< Forced air circulation >		Static cooling
Content litres (gross):	100	100	100
Ext. dimensions (WxDxH)	mm: 600x600x850	600x600x850	600x600x850
Int. dimensions (WxDxH)	mm: 475x440x460	475x440x460	475x430x460
Depth with door opened	mm: 1135	1135	1135
Shelves	: 2	2	2
Weight	kgs: 73	76	73
Mains connection	:	< 1/N/PE ~ 230 V 50 Hz >	
Shipping dimensions (WxDxH)	mm: 680x680x1050	680x680x1050	680x680x1050
Shipping weight	kgs: 84	87	84
Refrigerant CFC- and HCFC-free	: R134a	R134a	R134a

LabStar Sanguis + Accessories:

Outside / Inside

Cat. No.

LabStar Sanguis LSSA1105EWU	white / CNS	GSLSSA1105EWU
LabStar Sanguis LSSA1105GEWU	white, glass door / CNS	GSLSSA1105GEWU
LabStar Sanguis LSSA1105EWN	white / CNS	GSLSSA1105EWN

ProfiTec Temperature Monitoring and Recording System (see sep. brochure). GPTEC4A

ProfiCaller telephone dialler (see sep. brochure). on request

Pt-100 temperature sensor, add. installed for ext. temperature recording. ZXX2-020-2L

SMS alarm (to 5 mobile numbers maximum). on request

Circular chart recorder for 7 days. Mains-independent. on request

7-day circular charts. Pck. of 100 pieces. on request

Battery-BackUp-System for full retention of all controller features on request

incl. alarm in the event of power failure (for up to 48 hours).

Ex-Version „Interior free of ignition sources“ (LSSA1105EWN only). ZLSSA1-070

Stainless steel shelf, 444x410 mm (WxD). ZLSSA4-444x410

Guide rails for stainless steel shelf (1 pair). ZLSSA4-023

Drawer with telescopic slide-out, made of CNS. ZLSSA4-001

Internal dividers for drawer. 1 set consisting of 3 dividers. ZLSSA4-010

MIN/MAX thermometer to be placed in refrigerators or freezers. ZXX2-019-001

Measuring range -50/+50 °C, an add. temperature sensor is not required.

MIN/MAX digital thermometer. Hand-held unit with digital display as well as ZXX2-019-011

data-hold and relative measuring function. Measuring range -200/+1370 °C.

An add. temperature sensor is required, eg. Cat.-No. ZXX2-022-100. ZXX2-022-100

Temperature sensor for MIN/MAX thermometer ZXX2-019-011.

Measuring range -100/+1000 °C. Length 2 m. Other ranges on request.

Export version with special voltages / frequencies. on request

ProfiTec Intelligent Temperature Monitoring and Recording System



- For up to 4 refrigerators and/or freezers
- Readings are stored over a period up to 781 days
- Warning for excess and insufficient temperature
- Includes No-volt remote alarm contact
- The measuring protocol can be fed to PC via RS 232 port

Inventory Systems

Stainless steel racks, freezer cassettes and grid inserts enable specimens to be stored and retrieved in a clear and orderly manner. Optimum use is made of the storage capacity.

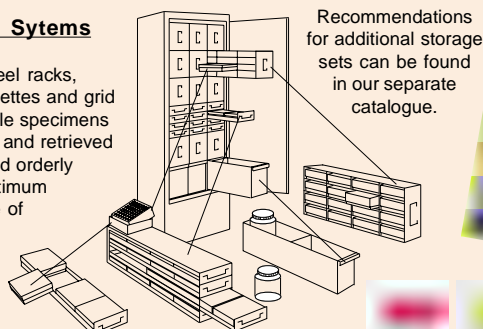

Recommendations for additional storage sets can be found in our separate catalogue.

Please ask for a personal fitting option.



MIN/MAX digital thermometer with add. temperature sensor



Laboratory Upright Freezer LabStar Sanguis LSSA

- Static cooling and manual defrost
- Micro-processor driven temperature controller
 - Visual/audible alarm device
 - Alarm warning for excess and insufficient temperature
 - Probe failure alarm
 - Door alarm
 - Integrated data logger
 - USB port for data download
- No-volt remote alarm contact for connection to a remote alarm system
- External housing made of white corrosion-resistant, galvanized steel plate with PVC finish
- Self-closing and lockable door
- Door hinges on right, changeable
- Door seal changeable
- 2 drawers with telescopic slide-out
- Interior made of stainless steel CNS
- 4 castors, 2 height adjustable feet at rear



LabStar Sanguis LSSA1130EWN

Model LabStar Sanguis LSSA1130EWN

Temperature range	°C:	-10 / -30
		Static cooling
Content	litres (gross):	100
Ext. dimensions (WxDxH)	mm:	600x600x850
Int. dimensions (WxDxH)	mm:	475x440x460
Depth with door opened	mm:	1135
Drawers	:	2
Weight	kgs:	81
Mains connection	:	1/N/PE ~ 230 V 50 Hz
Shipping dimensions (WxDxH)	mm:	680x680x1050
Shipping weight	kgs:	92
Refrigerant CFC- and HCFC-free	:	R290

LabStar Sanguis + Accessories: Outside / Inside Cat. No.

LabStar Sanguis LSSA1130EWN	white / CNS	GSLSSA1130EWN
ProfiTec Temperature Monitoring and Recording System (see separate data sheet).		GPTEC4A
ProfiCaller telephone dialler.		on request
Pt-100 temperature sensor, add. installed for ext. temperature recording.		ZXX2-020-2L
Circular chart recorder for 7 days. Mains-independent.		on request
7-day circular charts. Pck. of 100 pieces.		on request
Battery-BackUp-System for full retention of all controller features incl. alarm in the event of power failure (for up to 48 hours).		on request
Ex-Version „Interior free of ignition sources“.		ZLSSA1-070
Internal dividers for drawer. 1 set consisting of 3 dividers.		ZLSSA4-010
MIN/MAX thermometer to be placed in refrigerators or freezers.		ZXX2-019-001
Measuring range -50/+50 °C, an add. temperature sensor is not required.		
MIN/MAX digital thermometer. Hand-held unit with digital display as well as data-hold and relative measuring function. Measuring range -200/+1370 °C.		ZXX2-019-011
An add. temperature sensor is required, eg. Cat.-No. ZXX2-022-100.		
Temperature sensor for MIN/MAX thermometer ZXX2-019-011.		ZXX2-022-100
Measuring range -100/+1000 °C. Length 2 m. Other ranges on request.		
USB data logger to be placed in refrigerators or freezers.		

ProfiTec Intelligent Temperature Monitoring and Recording System



- For up to 4 refrigerators and/or freezers
- Readings are stored over a period up to 781 days
- Warning for excess and insufficient temperature
- Includes No-volt remote alarm contact
- The measuring protocol can be fed to PC via RS 232 port

Inventory Systems

Stainless steel racks, freezer cassettes and grid inserts enable specimens to be stored and retrieved in a clear and orderly manner. Optimum use is made of the storage capacity.

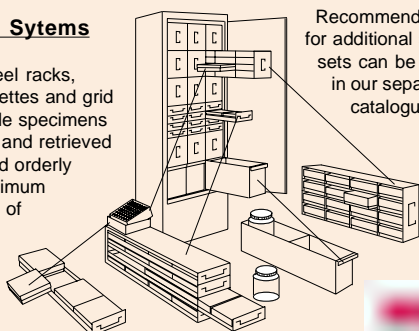

Recommendations for additional storage sets can be found in our separate catalogue.

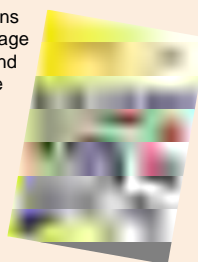

Please ask for a personal fitting option.



MIN/MAX digital thermometer with add. temperature sensor

www.NationalLab.com

National Lab GmbH
Grambeker Weg 157
D-23879 Moelln

Tel.: +49 45 42 / 84 91 - 70
Fax: +49 45 42 / 84 91 - 71
e-Mail: LabSales@NationalLab.com

**also available
with solid door**



Model No.	ML0406GWU	ML0806GWU	ML1006GWU	ML1506GWU	ML3006GWU	ML3506GWU
Temperature range	+2 °C to +8 °C	+2 °C to +8 °C	+2 °C to +8 °C	+2 °C to +8 °C	+2 °C to +8 °C	+2 °C to +8 °C
Forced air circulation	Yes	Yes	Yes	Yes	Yes	Yes
Defrost (automatic / manual)	automatic	automatic	automatic	automatic	automatic	automatic
Electronic controller	Yes	Yes	Yes	Yes	Yes	Yes
Digital display	Yes	Yes	Yes	Yes	Yes	Yes
Temperature alarm visual / audible	Yes	Yes	Yes	Yes	Yes	Yes
Excess and insufficient temp. alarm	Yes	Yes	Yes	Yes	Yes	Yes
Open door alarm	Yes	Yes	Yes	Yes	Yes	Yes
No-volt remote alarm	No	No	Yes	Yes	Yes	Yes
External finish	painted steel plate	painted steel plate	painted steel plate	painted steel plate	painted steel plate	painted steel plate
Colour	white	white	white	white	white	white
Lock	Yes	Yes	Yes	Yes	Yes	Yes
Door type	glass door	glass door	glass door	glass door	glass door	glass door
Door hinges	not changeable	changeable	changeable	changeable	changeable	changeable
Door seal	not changeable	changeable	changeable	changeable	changeable	changeable
Internal finish	plastic, white	plastic, white	plastic, white	plastic, white	plastic, white	plastic, white
Interior light	No	Yes	Yes	Yes	Yes	Yes
Spark free	No	No	No	No	No	No
Shelves (number)	2	2	2	3	5	6
Shelf positions (number)	5	2	4	6	12	14
Shelf size (mm) (WxDxH)	270x308x6	438x274x6	427x374x6	520x400x6	4: 500x385x6 1: 497x340x6	500x385x6
Wire baskets (number)	0	1	1	1	1	1
Optional drawer system	Yes	Yes	Yes	Yes	Yes	Yes
Adjustable feet (number & position)	No	No	1 front foot	2 front feet 2 rear rollers	2 front feet 2 rear rollers	2 front feet 2 rear rollers
Gross capacity (l)	41	82	107	151	273	334
Net capacity (l)	35	67	103	141	269	331
External width (mm)	379	502	495	595	595	595
External depth (mm)	500	540	620	635	660	660
Door open depth (mm)	810	976	1050	1165	1180	1180
External height (mm)	702	660	830	845	1565	1860
Internal dimensions (mm) (WxDxH)	245x310x400	419x320x540	403x400x700	500x450x705 step (DxH): 165x185	480x445x1382 step (DxH): 255x175	480x445x1682 step (DxH): 265x175
Product weight (kg)	25.5	30	36.5	42	68.5	79
Voltage supply	1/N/PE~230V 50Hz	1/N/PE~230V 50Hz	1/N/PE~230V 50Hz	1/N/PE~230V 50Hz	1/N/PE~230V 50Hz	1/N/PE~230V 50Hz
Packed width (mm)	700	700	700	700	700	700
Packed depth (mm)	750	750	750	750	750	750
Packed height (mm)	890	825	1000	1022	1735	2035
Packed weight (kg)	32.5	37	43.5	49	75.5	86
Refrigerant type CFC / HCFC free	R134a	R134a	R134a	R600a	R600a	R600a



Recommendations for additional storage sets can be found in our separate catalogue. Please ask for a personal fitting option.

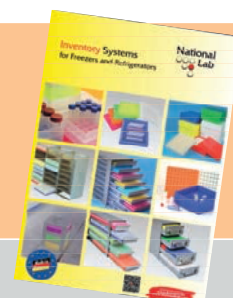

*also available
with glas door*



Model No.	ML0406WU	ML0506WU	ML0806WU	ML1006WU	ML1506WU	ML3006WU	ML3506WU
Temperature range	+2 °C to +8 °C	+2 °C to +8 °C	+2 °C to +8 °C	+2 °C to +8 °C	+2 °C to +8 °C	+2 °C to +8 °C	+2 °C to +8 °C
Forced air circulation	Yes	Yes	Yes	Yes	Yes	Yes	Yes
Defrost (automatic / manual)	automatic	automatic	automatic	automatic	automatic	automatic	automatic
Electronic controller	Yes	Yes	Yes	Yes	Yes	Yes	Yes
Digital display	Yes	Yes	Yes	Yes	Yes	Yes	Yes
Temperature alarm visual / audible	Yes	Yes	Yes	Yes	Yes	Yes	Yes
Excess and insufficient temp. alarm	Yes	Yes	Yes	Yes	Yes	Yes	Yes
Open door alarm	Yes	No	Yes	Yes	Yes	Yes	Yes
No-volt remote alarm	No	No	No	Yes	Yes	Yes	Yes
External finish	painted steel plate	painted steel plate	painted steel plate	painted steel plate	painted steel plate	painted steel plate	painted steel plate
Colour	white	white	white	white	white	white	white
Lock	Yes	Yes	Yes	Yes	Yes	Yes	Yes
Door type	solid door	solid door	solid door	solid door	solid door	solid door	solid door
Door hinges	not changeable	changeable	changeable	changeable	changeable	changeable	changeable
Door seal	not changeable	not changeable	not changeable	not changeable	not changeable	not changeable	not changeable
Internal finish	plastic, white	plastic, white	plastic, white	plastic, white	plastic, white	plastic, white	plastic, white
Interior light	No	No	No	No	No	Yes	Yes
Spark free	No	No	No	No	No	No	No
Shelves (number)	2	1	2	2	3	5	6
Shelf positions (number)	5	1	2	4	6	12	14
Shelf size (mm) (WxDxH)	270x308x6	402x200x6	438x274x6	427x374x6	520x400x6	4: 500x385x6 1: 497x340x6	500x385x6
Wire baskets (number)	0	1	1	1	1	1	1
Optional drawer system available	Yes	Yes	Yes	Yes	Yes	Yes	Yes
Adjustable feet (number & position)	No	2 front feet	No	1 front foot	2 front feet 2 rear rollers	2 front feet 2 rear rollers	2 front feet 2 rear rollers
Gross capacity (l)	41	45	82	107	151	273	334
Net capacity (l)	35	37	67	103	141	269	331
External width (mm)	379	470	502	495	595	595	595
External depth (mm)	500	465	540	620	635	670	670
Door open depth (mm)	810	910	976	1050	1165	1185	1185
External height (mm)	702	530	660	830	845	1565	1860
Internal dimensions (mm) (WxDxH)	245x310x400	410x270x400	419x315x540	403x400x700	500x450x705 step (DxH): 165x185	480x445x1382 step (DxH): 255x175	480x445x1682 step (DxH): 265x175
Product weight (kg)	23.5	20	27.5	31.5	37	60	69
Voltage supply	1/N/PE~230V 50Hz	1/N/PE~230V 50Hz	1/N/PE~230V 50Hz	1/N/PE~230V 50Hz	1/N/PE~230V 50Hz	1/N/PE~230V 50Hz	1/N/PE~230V 50Hz
Packed width (mm)	700	700	700	700	700	700	700
Packed depth (mm)	750	750	750	750	750	750	750
Packed height (mm)	890	825	825	1000	1022	1735	2035
Packed weight (kg)	30.5	27	34.5	38.5	44	67	76
Refrigerant type CFC / HCFC free	R134a	R134a	R134a	R134a	R600a	R600a	R600a



Recommendations for additional storage sets can be found in our separate catalogue. Please ask for a personal fitting option.

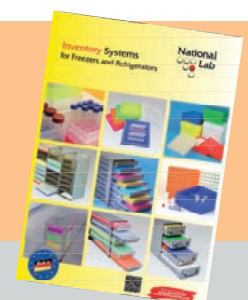



ML0406GWU



ML0406WU



ML0806GWU



ML0806WU



ML1006GWU



ML1006WU



ML1506GWU



ML1506WU



ML3006GWU



ML3006GWU



ML3006WU



ML3006WU



Recommendations for additional storage sets can be found in our separate catalogue. Please ask for a personal fitting option.

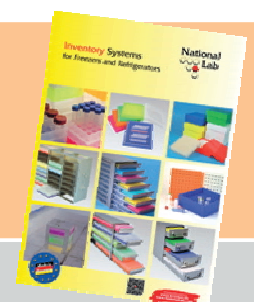



Model No.	ML0801WU	ML1501WU	ML3001WU
Temperature range	+1 °C to +5 °C	+1 °C to +5 °C	+1 °C to +5 °C
Forced air circulation	Yes	Yes	Yes
Defrost (automatic / manual)	automatic	automatic	automatic
Electronic controller	Yes	Yes	Yes
Digital display	Yes	Yes	Yes
Temperature alarm visual / audible	Yes	Yes	Yes
Excess and insufficient temp. alarm	Yes	Yes	Yes
Open door alarm	No	Yes	Yes
No-volt remote alarm	No	No	No
External finish	painted steel plate	painted steel plate	painted steel plate
Colour	white	white	white
Lock	Yes	Yes	Yes
Door type	solid door	solid door	solid door
Door hinges	changeable	changeable	changeable
Door seal	not changeable	not changeable	not changeable
Internal finish	plastic, white	plastic, white	plastic, white
Interior light	No	No	Yes
Spark free	No	No	No
Shelves (number)	2	3	5
Shelf positions (number)	2	6	12
Shelf size (mm) (WxDxH)	440x275x6	520x320x6	497x340x6
Drawers (number)	0	0	1
Wire baskets (number)	1	1	0
Door bins (number)	0	2 (fixed)	4 (adjustable)
Optional drawer system	Yes	Yes	Yes
Adjustable feet (number & position)	No	2 front feet 2 rear rollers	2 front feet 2 rear rollers
Gross capacity (l)	82	151	288
Net capacity (l)	67	145	284
External width (mm)	502	635	595
External depth (mm)	540	595	670
Door open depth (mm)	976	1165	1185
External height (mm)	660	845	1570
Internal dimensions (mm) (WxDxH)	419x315x540 step (DxH): 165x215	500x450x705 step (DxH): 165x210	480x445x1382 step (DxH): 200x260
Product weight (kg)	27.5	37	59
Voltage supply	1/N/PE~230V 50Hz	1/N/PE~230V 50Hz	1/N/PE~230V 50Hz
Packed width (mm)	700	700	700
Packed depth (mm)	750	750	750
Packed height (mm)	825	1022	1735
Packed weight (kg)	34.5	44	66
Refrigerant type CFC / HCFC free	R134a	R600a	R600a



ML0801WU



ML0801WU with Inventory System (optional)



ML1501WU



ML3001WU



ML3001WU with Inventory System (optional)



Recommendations for additional storage sets can be found in our separate catalogue. Please ask for a personal fitting option.

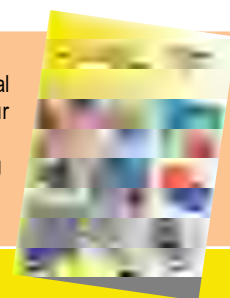



Model No.	ML0806WN	ML1006WN	ML1506WN	ML3006WN
Temperature range	+2 °C to +10 °C	+2 °C to +10 °C	+2 °C to +10 °C	+2 °C to +10 °C
Forced air circulation	No	No	No	No
Defrost (automatic / manual)	automatic	automatic	automatic	automatic
Electronic controller	Yes	Yes	Yes	Yes
Digital display	Yes	Yes	Yes	Yes
Temperature alarm visual / audible	Yes	Yes	Yes	Yes
Excess and insufficient temp. alarm	Yes	Yes	Yes	Yes
Open door alarm	No	No	Yes	Yes
No-volt remote alarm	No	No	Yes	Yes
External finish	painted steel plate	painted steel plate	painted steel plate	painted steel plate
Colour	white	white	white	white
Lock	Yes	Yes	Yes	Yes
Door type	solid door	solid door	solid door	solid door
Door hinges	changeable	changeable	changeable	changeable
Door seal	not changeable	not changeable	not changeable	not changeable
Internal finish	plastic, white	plastic, white	plastic, white	plastic, white
Interior light	No	No	No	No
Spark free	Yes	Yes	Yes	Yes
Shelves (number)	2	2	3	5
Shelf positions (number)	2	4	6	12
Shelf size (mm) (WxDxH)	438x274x6	427x374x6	520x320x6	497x340x6
Drawers (number)	0	0	0	1
Wire baskets (number)	1	1	1	0
Adjustable door bins (number)	0	0	2	4
Optional drawer system	Yes	Yes	Yes	Yes
Adjustable feet (number & position)	No	2 front feet	2 front feet 2 rear rollers	2 front feet 2 rear rollers
Gross capacity (l)	82	107	151	288
Net capacity (l)	67	103	145	284
External width (mm)	502	495	595	595
External depth (mm)	540	620	595	634
Door open depth (mm)	976	1050	1165	1185
External height (mm)	660	830	845	1570
Internal dimensions (mm) (WxDxH)	415x340x540	403x400x540	500x450x705 step (DxH): 165x185	480x445x1382 step (DxH): 175x255
Product weight (kg)	27.5	31.5	36	58
Voltage supply	1/N/PE-230V 50Hz	1/N/PE-230V 50Hz	1/N/PE-230V 50Hz	1/N/PE-230V 50Hz
Packed width (mm)	700	700	700	700
Packed depth (mm)	750	750	750	750
Packed height (mm)	825	1000	1022	1735
Packed weight (kg)	34.5	38.5	43	65
Refrigerant type CFC / HCFC free	R134a	R134a	R600a	R600a



ML0806WN



ML0806WN with Inventory System (optional)



ML1006WN



ML1006WN with Inventory System (optional)



ML1506WN



ML1506WN with Inventory System (optional)



ML3006WN



Recommendations for additional storage sets can be found in our separate catalogue. Please ask for a personal fitting option.

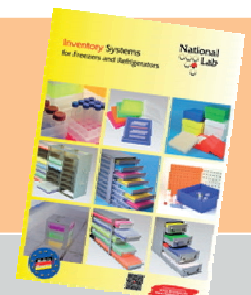



Model No.	ML0521WN	ML1225WN	ML1625WN	ML3125WN
Temperature range	-18 °C to -25 °C	-18 °C to -25 °C	-18 °C to -25 °C	-18 °C to -25 °C
Forced air circulation	No	No	No	No
Defrost (automatic / manual)	manual	manual	manual	manual
Electronic controller	Yes	Yes	Yes	Yes
Digital display	Yes	Yes	Yes	Yes
Temperature alarm visual / audible	Yes	Yes	Yes	Yes
Excess and insufficient temp. alarm	Yes	Yes	Yes	Yes
Open door alarm	No	No	Yes	Yes
No-volt remote alarm	No	No	Yes	Yes
External finish	painted steel plate	painted steel plate	painted steel plate	painted steel plate
Colour	white	white	white	white
Lock	Yes	Yes	Yes	Yes
Door type	solid door	solid door	solid door	solid door
Door hinges	changeable	changeable	changeable	changeable
Door seal	not changeable	not changeable	not changeable	not changeable
Internal finish	plastic, white	plastic, white	plastic, white	plastic, white
Interior light	No	No	No	No
Spark free	Yes	Yes	Yes	Yes
Shelves (number)	1	0	0	0
Cooling spirals (number)	0	2	2	5
Shelf positions (number)	1	2 (fixed)	2 (fixed)	5 (fixed)
Shelf size (mm) (WxDxH)	340x180x6	-	-	-
Drawers (number)	0	0	0	4 and 2 flaps
Wire baskets (number)	0	1	3	0
Optional drawer system	Yes	Yes	Yes	Yes
Adjustable feet (number & position)	No	1 front foot	2 front feet 2 rear rollers	2 front feet 2 rear rollers
Gross capacity (l)	50	102	151	232
Net capacity (l)	38	87	134	212
External width (mm)	500	495	595	595
External depth (mm)	510	620	595	634
Door open depth (mm)	976	1050	1165	1185
External height (mm)	562	830	845	1570
Internal dimensions (mm) (WxDxH)	345x330x365	414x415x683	500x450x705 step (DxH): 165x185	432x430x1300 step (DxH): 190x255
Product weight (kg)	17	33	36	60
Voltage supply	1/N/PE~230V 50Hz	1/N/PE~230V 50Hz	1/N/PE~230V 50Hz	1/N/PE~230V 50Hz
Packed width (mm)	700	700	700	700
Packed depth (mm)	750	750	750	750
Packed height (mm)	740	1000	1022	1735
Packed weight (kg)	24	40	43	67
Refrigerant type CFC / HCFC free	R134a	R134a	R600a	R600a



ML0521WN



ML0521WN with Inventory System (optional)



ML1225WN



ML1225WN with Inventory System (optional)



ML1625WN



ML3125WN



Recommendations for additional storage sets can be found in our separate catalogue. Please ask for a personal fitting option.



Laboratory Upright Freezer ProfiFrost PFU / PF

- Static cooling and manual defrost
- Maintenance-free cooling system
- Low-noise and low-vibration fully hermetic compressor, air-cooled
- Operating panel with micro-processor driven temperature controller and graphic display in separate upright housing (can be positioned as per customer requirements)
- Visual/audible alarm device
 - Mains-independent
 - Alarm warning for excess and insufficient temperature
 - No-volt remote alarm contact for connection to a remote alarm system
 - RS 485 port
- Data logger for recording events (temperature change, exceeding limits, alarms triggered).
- External housing made of white, galvanized steel plate
- Freeze-proof special seal
- Lockable door (PFU14.. only, others on request)
- Door hinges on right, changeable
- Interior with closed removable plastic drawers (PFU14.. with 1 additional storage basket. PF27.. with 2 additional compartments above.)
- Feet made of plastic (PVC) (at PF27.. front feet of cabinet allow for height adjustment, two castors at rear)



ProfiFrost PFU1447WN **

Model ProfiFrost	PFU0833WN	PFU0841WN	PFU1433WN	PFU1447WN	PF2728WN	PF2747WN
Temperature range	°C: -16/-30	-16/-40	-14/-30	-14/-45	-16/-28	-16/-45
Content	litres gross: 70	70	143	143	241	241
Ext. dimensions (WxDxH)*	mm: 555x624x630	555x680x630	600x615x830	600x615x830	600x650x1700	600x650x1700
Depth with door opened	mm: 1165	1260	1215	1215	1140	1140
Number of drawers/compartments	: 2/0	2/0	3/1	3/1	5/2	5/2
Weight	kgs: 31	31	45	45	73	73
Mains connection	: < 1/N/PE ~ 220-230 V 50 Hz >	< 1/N/PE ~ 220-230 V 50 Hz >	< 1/N/PE ~ 220-230 V 50 Hz >	< 1/N/PE ~ 220-230 V 50 Hz >	< 1/N/PE ~ 220-230 V 50 Hz >	< 1/N/PE ~ 220-230 V 50 Hz >
Shipping dimensions (WxDxH)	mm: 700x750x790	700x750x790	700x750x990	700x750x990	700x750x1860	700x750x1860
Shipping weight	kgs: 40	40	54	54	83	83
Refrigerant CFC- and HCFC-free	: R600a	R507	R600a	R507	R600a	R507

* Positioning the upright housing¹⁾ with the operating panel on the cabinet increases the height by 90 mm. The flexible connecting lead allows the unit to be positioned as per customer requirements.

Alternative units: ProfiLine Uranus.

Model	Outside / Inside	Cat. No.
ProfiFrost PFU0833WN	white / white	GSPFU0833WN
ProfiFrost PFU0841WN	white / white	GSPFU0841WN
ProfiFrost PFU1433WN	white / white	GSPFU1433WN
ProfiFrost PFU1447WN	white / white	GSPFU1447WN
ProfiFrost PF2728WN	white / white	GSPF2728WN
ProfiFrost PF2747WN	white / white	GSPF2747WN



ProfiFrost PF2728WN **

Accessories	Cat. No.
ProfiTec Temperature Monitoring and Recording System (see sep. brochure).	GPTEC4A
ProfiCaller telephone dialler (see sep. brochure).	on request
Pt-100 temperature sensor, add. installed for ext. temperature recording.	ZPM2-023-2L
Ex-Version „Interior free of ignition sources.“	ZPF1-070
Transport carriage with 4 castors (2 lockable).	ZPFU5-021
Door lock, factory mounted PFU08.. and PF27.. only).	on request

** The arrangement system (cryoboxes, etc.) that can be seen in the laboratory freezers is optional. See our separate catalogue for Inventory Systems.



Temperature controller with graphic display and data logger



National Lab GmbH
Grambeker Weg 157
D-23879 Mölln
Tel.: +49 45 42 / 84 91 - 70
Fax: +49 45 42 / 84 91 - 71
e-Mail: LabSales@NationalLab.com

Laboratory Upright Freezer and Refrigerator/Freezer Combination ProfiFrost

- Maintenance-free cooling system (combination with 2 separate cooling systems)
- Low-noise and low-vibration fully hermetic compressors, air-cooled
- Electronic control with digital display (combination with 2 separate controllers)
- Visual/audible alarm device
 - Alarm warning for excess and insufficient temp.
 - Door alarm
 - MIN/MAX temperature memory
 - No-volt remote alarm contact for connection to a remote alarm system
- RS 485 port
- Duct to storage compartment for external temperature sensors
- External housing made of white, galvanized steel plate
- Self-closing and lockable doors
- Door hinges on right, changeable
- Interior made of white plastic
- Ex-interior free of electrical ignition sources (except for PFU40xxKWU)
- Front feet of cabinet allow for height adjustment, two castors at rear



ProfiFrost PFU16xxWN
(Fig. with optional cryoboxes.
See catalogue.)

Model ProfiFrost	PFU1630WN	PFU1645WN	PFU3530WN	PFU3545WN
Temperature range °C:	-10/-30	-20/-45	-10/-30	-20/-45
Content litres gross/net:	140/130	140/130	310/285	310/285
Cooling system :	static	static	static	static
Defrosting :	manual	manual	manual	manual
Ext. dimensions (WxDxH) mm:	< 600x615x820 >		< 600x615x1840 >	
Int. dimensions (WxDxH) mm:	< 475x450x660 >		< 430x430x1590 >	
Depth with door opened mm:	1190	1190	1175	1175
Number of drawers :	3	3	8	8
Int. dimensions drawer (WxDxH) mm:	< 435x415x110 >		< 420x375x180 > < Lowest drawer D = 220 >	
Number of baskets :	1	1	0	0
Weight kg:	42	42	87	87
Mains connection :	< 1/N/PE ~ 230 V 50 Hz >		< 1/N/PE ~ 230 V 50 Hz >	
Energy consumption kWh/24h:	0.9	1.4	1.3	1.5
Shipping dimensions (WxDxH) mm:	< 700x750x1000 >		< 700x750x2000 >	
Shipping weight kg:	51	51	99	99
Refrigerant CFC- and HCFC-free:	R600a	R290	R600a	R290



ProfiFrost PFU35xxWN
(Fig. with optional cryoboxes.
See catalogue.)

Combination Model ProfiFrost	PFU4030KWU		PFU4040KWU	
	Refrigerator	Freezer	Refrigerator	Freezer
Temperature range °C:	+3/+15	-10/-30	+3/+15	-20/-40
Content litres gross/net:	255/240	110/105	255/240	110/105
Cooling system :	forced air	static	forced air	static
Defrosting :	automatic	manual	automatic	manual
Ext. dimensions (WxDxH) mm:	600x615x2000		600x720x2000	
Int. dimensions (WxDxH) mm:	450x455x1110	455x435x595	450x455x1110	455x435x595
Depth with door opened mm:	1120	1120	1120	1120
Number of drawers freezer comp.:	0	3	0	3
Int. dimensions drawer (WxDxH) mm:	-	420x375x180	-	420x375x180
Number of shelves :	4 grid inserts	2 glass shelves	4 grid inserts	2 glass shelves
Weight kg:	85		90	
Mains connection :	1/N/PE ~ 230 V 50 Hz		1/N/PE ~ 230 V 50 Hz	
Energy consumption kWh/24h:	1.8		2.3	
Shipping dimensions (WxDxH) mm:	700x750x2150		700x750x2150	
Shipping weight kg:	98		103	
Refrigerant CFC- and HCFC-free:	R600a	R600a	R600a	R290



ProfiFrost PFU40xxKWU
(Fig. with inventory system.
See catalogue.)

Options / Accessories:

	Cat. No.
ProfiTec Temperature Monitoring and Recording System (see separate brochure). USB data logger to be placed in refrigerators or freezers. Measuring range -35/+80 °C, an add. temperature sensor is not required.	GPTEC4A ZXX2-045-007
ProfiCaller telephone dialler.	on request
Pt-100 temperature sensor, add. installed for external temperature recording.	ZPFU2-023-2L
Grid inserts for refrigerator compartment (Combi model only).	ZPFU4-480x420
Drawer with telescopic slide-out for refrigerator compartment (Combi model only).	on request
Duct to storage compartment closed according to BGR 120 / GUV-R 120.	ZPFU1-070
Door hinges factory-mounted on left.	ZPFU5-001
Transport carriage with 4 castors (2 lockable).	ZPFU5-021

Inventory Systems

Stainless steel racks, cryoboxes and grid inserts enable specimens to be stored and retrieved in a clear and orderly manner. Optimum use is made of the storage capacity.

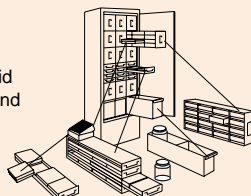

Recommendations for additional storage sets can be found in our separate catalogue.

Please ask for a personal fitting option.

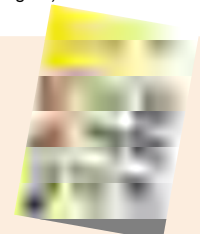

Laboratory Upright Freezer ProfiLine Pegasus PLPE

- Static cooling and manual defrost
- Most reliable and less complicated compressor technology
- 2 separate, redundant operating cooling circuits for a maximum safety (PLPE2586EWN only)
- Micro-processor driven temperature controller with digital display
- Visual/audible alarm device, mains-independent
 - Alarm warning for excess and insufficient temperature
 - Power failure alarm
 - Door alarm
 - No-volt remote alarm contact
- Integrated data logger with USB port
- Duct to storage compartment for external temperature sensor
- Lockable door
- Door hinges on right, changeable
- Door seal changeable
- Height adjustable shelves (standard fitting see below)
- External housing made of white, galvanized steel plate
- Interior made of stainless steel CNS
- LED interior lighting
- 4 castors, 2 lockable (Feet at PLPE 1086EWN)



ProfiLine Pegasus PLPE 1086EWN (Fig. with optional cryo boxes. See catalogue.)

Model ProfiLine Pegasus	PLPE 1086EWN	PLPE 2545EWN	PLPE 2560EWN	PLPE 2586EWN
Temperature range °C:	-60/-86	-10/-45	-30/-60	-60/-86
Content litres gross:	96	250	250	250
Content litres net:	91	236	221	221
Ext. dimensions (WxDxH) mm:	595x695x825	600x690x2055	600x690x2055	600x705x2055
Int. dimensions (WxDxH) mm:	430x425x625	435x400x1435	435x400x1435	435x375x1435
Depth with door opened mm:	1205	1205	1205	1205
Inner doors:	0	0	2	2
Stainless steel shelves:	2	5	5	5
Weight kg:	60	122	122	130
Mains connection:	1/N/PE ~ 230 V 50 Hz	1/N/PE ~ 230 V 50 Hz	1/N/PE ~ 230 V 50 Hz	1/N/PE ~ 230 V 50 Hz
Shipping dimensions (WxDx mm):	710x790x1080	640x690x2240	640x690x2240	640x690x2240
Shipping weight kg:	86	135	135	143
Refrigerant CFC- and HCFC-free:	Mix	Mix	Mix	Mix

Available end 2019

Accessories

Accessories	Cat. No.
ProfiTec Temperature Monitoring and Recording System (see separate data sheet).	GPTEC4A
ProfiCaller telephone dialler.	on request
Pt-100 temperature sensor, add. installed for ext. temperature recording.	ZXX2-020-2L
Stainless steel shelf for PLPE 1086EWN.	on request
Stainless steel shelf for PLPE 25..EWN.	on request
CO ₂ back-up system, free-standing.	on request
Facilities for customer connection of CO ₂ back-up system.	on request
MIN/MAX digital thermometer. Hand-held unit with digital display as well as data-hold and relative measuring function. Measuring range -200/+1370 °C.	ZXX2-019-011
An add. temperature sensor is required, eg. Cat.-No. ZXX2-022-100.	
Temperature sensor for MIN/MAX thermometer ZXX2-019-011.	ZXX2-022-100
Measuring range -100/+1000 °C. Length 2 m. Other ranges on request.	



ProfiLine Pegasus PLPE 2545EWN (Fig. with optional cryo boxes. See catalogue.)

Storage System Alternatives



Stainless steel horizontal racks



Stainless steel drawer racks



Stainless steel insert with drawers

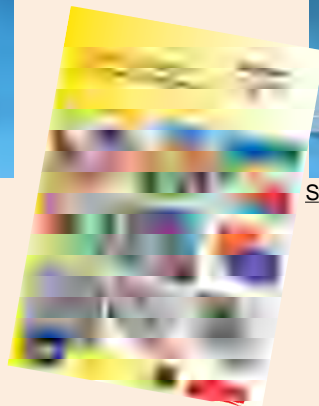

Recommendations for additional storage sets can be found in our separate catalogue.

Please ask for a personal fitting option.



ProfiLine Pegasus PLPE 2586EWN (Fig. with optional cryo boxes. See catalogue.)

Dual-Compressor System for maximum Safety

Labortiefkühlschrank ProfiLine Pegasus PLPE

- Forced air circulation with automatic defrost
- Micro-processor driven temperature controller with digital display and password protection
 - Visual/audible alarm device, mains-independent
 - Alarm warning for excess and insufficient temperature
 - Power failure alarm
 - Probe failure alarm
 - Door alarm
 - Integrated data logger with USB port
- No-volt remote alarm contact for connection to an alarm system on the premises
 - RS 485 port
 - Prepared for GSM alarm
- Lockable door, door hinges on right, can only be changed in factory
- External housing made of white, galvanized steel plate
- 3 adjustable grid inserts in tilt-resistant guide rails
- Interior made of stainless steel CNS
- 4 castors, 2 lockable



ProfiLine Pegasus PLPE6042EJU

Model ProfiLine Pegasus PLPE6042

Temperature range	°C:	-10/-40
Content	litres (gross):	618
Ext. dimensions (WxDxH)	mm:	740x870x2017
Int. dimensions (WxDxH)	mm:	600x685x1505
Depth with door opened	mm:	1490
Weight	kgs:	138
Mains connection	:	1/N/PE ~ 230 V 50-60 Hz
Shipping dimensions (WxDxH)	mm:	990x840x2200
Shipping weight	kgs:	167
Refrigerant CFC- and HCFC-free	:	R404A

ProfiLine Pegasus + Accessories: Outside / Inside Cat. No.

ProfiLine Pegasus PLPE 6042EJU	white / CNS	GSPLPE6042EJU
ProfiTec Temperature Monitoring and Recording System (see sep. brochure).		GPTEC4A
ProfiCaller telephone dialler.		on request
Circular chart recorder for 7 days.		on request
6" 7-day circular charts. Pck. of 100 pieces.		on request
Pt-100 temperature sensor, add. installed for ext. temperature recording.		ZXX2-020-2L
Grid inserts, 530x650 mm (WxD).		ZPLPE4-530x650
Guide rails for grid inserts (1 pair).		on request
Drawer with telescopic slide-out, made of CNS.		on request
CO2 back-up system, free-standing.		ZXX2-093
Facilities for customer connection of CO2 back-up system.		ZPLPE2-094
MIN/MAX thermometer to be placed in refrigerators or freezers.		ZXX2-019-001
Measuring range -50/+50 °C, an add. temperature sensor is not required.		
MIN/MAX digital thermometer. Hand-held unit with digital display as well as data-hold and relative measuring function. Measuring range -200/+1370 °C.		ZXX2-019-011
An add. temperature sensor is required, eg. Cat.-No. ZXX2-022-100.		
Temperature sensor for MIN/MAX thermometer ZXX2-019-011.		ZXX2-022-100
Measuring range -100/+1000 °C. Length 2 m. Other ranges on request.		

ProfiTec Intelligent Temperature Monitoring and Recording System



- For up to 4 refrigerators and/or freezers
- Readings are stored over a period up to 781 days
- Warning for excess and insufficient temperature
- Includes No-volt remote alarm contact
- The measuring protocol can be fed to PC via RS 232 port

Inventory Systems

Stainless steel racks, freezer cassettes and grid inserts enable specimens to be stored and retrieved in a clear and orderly manner. Optimum use is made of the storage capacity.

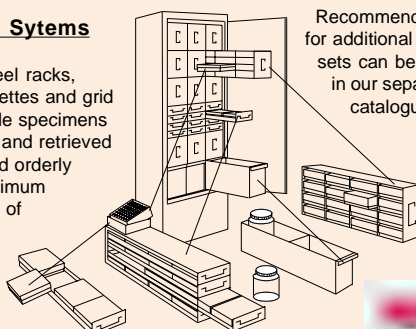

Recommendations for additional storage sets can be found in our separate catalogue.

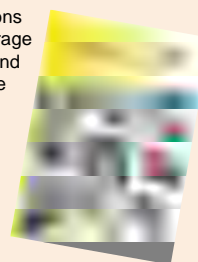

Please ask for a personal fitting option.



MIN/MAX digital thermometer with add. temperature sensor



Tel.: +49 45 42 / 84 91 - 70
 Fax: +49 45 42 / 84 91 - 71
 e-Mail: LabSales@NationalLab.com

National Lab GmbH
 Grambeker Weg 157
 D-23879 Moelln



Laboratory Upright Freezer ProfiLine Pegasus PLPE

- Static cooling and manual defrost
- 2 separate, redundant operating cooling circuits for a maximum safety (PLPE7286EWN only)
- Micro-processor driven temperature controller with digital display and password protection
 - Visual/audible alarm device, mains-independent
 - Alarm warning for excess and insufficient temperature
 - Power failure alarm
 - Probe failure alarm
 - Door alarm
 - Integrated data logger with USB port
- No-volt remote alarm contact for connection to an alarm system on the premises
- RS 485 port
- Prepared for GSM alarm
- Lockable door, door hinges on right, can only be changed in factory
- External housing made of white, galvanized steel plate
- Interior made of stainless steel CNS
- 5 compartments with additional inner doors
- Duct to storage compartment for external sensor
- 4 castors, 2 lockable



ProfiLine Pegasus PLPE 4286EWN

Model ProfiLine Pegasus	PLPE4240	PLPE4286	PLPE6240	PLPE6286	PLPE7240	PLPE7286
Temperature range °C:	-20/-40	-40/-86	-20/-40	-40/-86	-20/-40	-40/-86
Content litres (gross):	393	393	556	556	642	642
Number of compressors :	1	1	1	1	1	2
Ext.dimensions (WxDxH) mm:	720x885x1990		920x885x1990		1030x885x1990	
Dim. compartment (WxDxH) mm:	440x595x255		640x595x255		750x595x260	
Depth with door opened mm:	1475	1475	1675	1675	1790	1790
Weight kg:	175	175	203	203	242	242
Mains connection :	1/N/PE ~ 230 V 50-60 Hz		1/N/PE ~ 230 V 50-60 Hz		1/N/PE ~ 230 V 50-60 Hz	
Shipping dim. (WxDxH)* mm:	840x1040x2310*		1040x1070x2310*		1150x1070x2310*	
Shipping weight* kg:	244*	244*	333*	333*	388*	388*
Refrigerant CFC- and HCFC-free	R404A	EP88	R404A	EP88	R404A	EP88

* Shipping in a wooden box.

ProfiLine Pegasus + Accessories: Outside / Inside

ProfiLine Pegasus + Accessories: Outside / Inside	Cat. No.
ProfiLine Pegasus PLPE4240EWN white / CNS	GSPLPE4240EWN
ProfiLine Pegasus PLPE4286EWN white / CNS	GSPLPE4286EWN
ProfiLine Pegasus PLPE6240EWN white / CNS	GSPLPE6240EWN
ProfiLine Pegasus PLPE6286EWN white / CNS	GSPLPE6286EWN
ProfiLine Pegasus PLPE7240EWN white / CNS	GSPLPE7240EWN
ProfiLine Pegasus PLPE7286EWN white / CNS	GSPLPE7286EWN

ProfiTec Temperature Monitoring and Recording System (see separate data sheet). **GPTEC4A**

ProfiCaller telephone dialler. on request

Pt-100 temperature sensor, add. installed for ext. temperature recording. **ZXX2-020-2L**

Circular chart recorder for 7 days. on request

6" 7-day circular charts. Pck. of 100 pieces. on request

CO₂ back-up system, free-standing. **ZXX2-093**

Facilities for customer connection of CO₂ back-up system. **ZPLPE2-094**

MIN/MAX digital thermometer. Hand-held unit with digital display as well as **ZXX2-019-011**

data-hold and relative measuring function. Measuring range -200/+1370 °C.

An add. temperature sensor is required, eg. Cat.-No. **ZXX2-022-100**.

Temperature sensor for MIN/MAX thermometer **ZXX2-019-011**. **ZXX2-022-100**

Measuring range -100/+1000 °C. Length 2 m. Other ranges on request.

ProfiTec Intelligent Temperature Monitoring and Recording System



- For up to 4 refrigerators and/or freezers
- Readings are stored over a period up to 781 days
- Warning for excess and insufficient temperature
- Includes No-volt remote alarm contact
- The measuring protocol can be fed to PC via RS 232 port

Storage System (modifiable) for PLPE 42..

5 compartments each with 3 stainless steel racks to hold 16 boxes (height 50 mm) each. 15 x 16 = 240 boxes

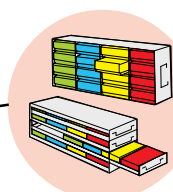
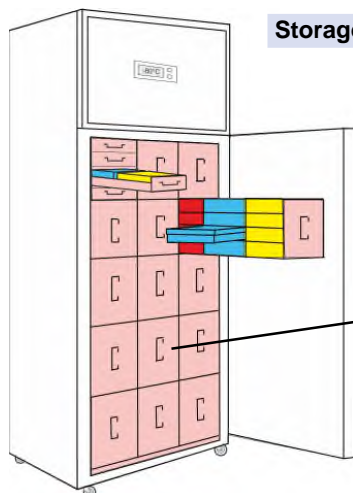

ALPHA Box

50 mm

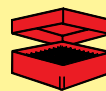

BRAVO Box

EPPi® Box

Please ask for a personal fitting option.

Recommendations for additional storage sets can be found in our separate catalogue.



Laboratory Refrigerator and Upright Freezer LabStar Sirius

- Forced air circulation with automatic defrost and condensate evaporation
- Cooling unit top
- Operating panel with main switch
 - Electronic control with digital display
 - Visual/audible alarm device
 - Alarm warning for excess and insufficient temperature
 - Door alarm
 - No-volt remote alarm contact for connection to a remote alarm system
- RS 485 port
- Self-closing and lockable door
- Door hinges on right, changeable
- Door seal changeable
- 3 adjustable grid inserts in tilt-resistant guide rails
- Interior made of stainless steel CNS
- 4 castors, 2 lockable



LabStar Sirius LSSI 3505GEWU

Model LabStar Sirius	LSSI 3505	LSSI 3505	LSSI 3530
Version	EWU/EEU	GEWU/GEEU Glass door	EWU/EEU
Temperature range °C:	+1/+10	+1/+10	-10/-30
Content litres (gross):	346	346	346
Content litres (net):	218	218	218
Ext. dimensions (WxDxH) mm:	520x700x1997	520x700x1997	520x700x1997
Int. dimensions (WxDxH) mm:	400x575x1505	400x575x1505	400x575x1505
Depth with door opened mm:	1182	1182	1182
Grid inserts:	3	3	3
Weight kgs:	98	98	103
Mains connection:	< 1/N/PE ~ 230 V 50-60 Hz >		
Shipping dimensions (WxDxH) mm:	650x780x2200	650x780x2200	650x780x2200
Shipping weight kgs:	112	112	117
Refrigerant CFC- and HCFC-free:	R134a	R134a	R290

LabStar Sirius + Accessories:	Outside / Inside	Cat. No.
LabStar Sirius LSSI 3505EWU	white / CNS	GSLSSI3505EWU
LabStar Sirius LSSI 3505EEU	CNS / CNS	GSLSSI3505EEU
LabStar Sirius LSSI 3505GEWU	white, glass door / CNS	GSLSSI3505GEWU
LabStar Sirius LSSI 3505GEEU	CNS, glass door / CNS	GSLSSI3505GEEU
LabStar Sirius LSSI 3530EWU	white / CNS	GSLSSI3530EWU
LabStar Sirius LSSI 3530EEU	CNS / CNS	GSLSSI3530EEU

- ProfiTec Temperature Monitoring and Recording System (see sep. brochure). **GPTEC4A**
- ProfiCaller telephone dialler (see sep. brochure). **on request**
- Pt-100 temperature sensor, add. installed for ext. temperature recording. **ZXX2-020-2L**
- Grid inserts, 330x545 mm (WxD). **ZLSSI4-330x545**
- Guide rails for grid inserts (1 pair). **ZLSSI4-023**
- Drawer with telescopic slide-out for LSSI 35xx, made of CNS. **ZLSSI4-003**
- Interior socket, tropical design. **ZLSSI1-001-01**
- Feet instead of castors, made of CNS (50 mm height adjustable). **ZLSSI5-021-125**
- Duct to storage compartment 26 mm in diameter. **ZLSSI1-002-26**
- MIN/MAX thermometer to be placed in refrigerators or freezers. **ZXX2-019-001**
- Measuring range -50/+50 °C, an add. temperature sensor is not required. **on request**
- MIN/MAX digital thermometer. Hand-held unit with digital display as well as data-hold and relative measuring function. Measuring range -200/+1370 °C. **ZXX2-019-011**
- An add. temperature sensor is required, eg. Cat.-No. ZXX2-022-100. **ZXX2-022-100**
- Temperature sensor for MIN/MAX thermometer ZXX2-019-011. **ZXX2-022-100**
- Measuring range -100/+1000 °C. Length 2 m. Other ranges on request.

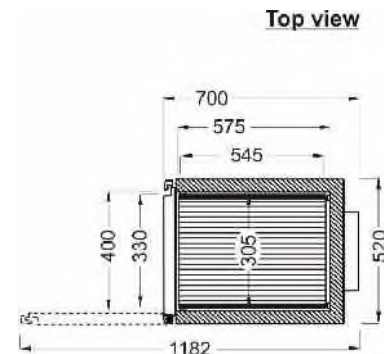

Side view

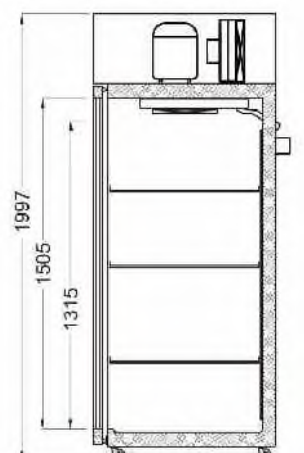

Inventory Systems

Stainless steel racks, freezer cassettes and grid inserts enable specimens to be stored and retrieved in a clear and orderly manner. Optimum use is made of the storage capacity.

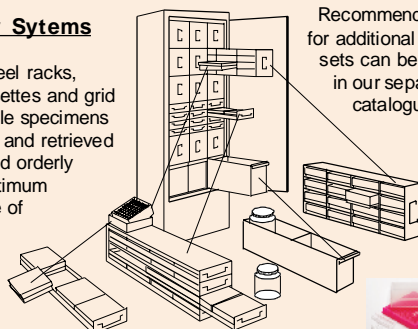

Recommendations for additional storage sets can be found in our separate catalogue.



Please ask for a personal fitting option.



Laboratory Refrigerator and Upright Freezer LabStar Sirius

- Forced air circulation with automatic defrost and condensate evaporation
- Cooling unit top
- Operating panel with main switch
 - Electronic control with digital display
 - Visual/audible alarm device
 - Alarm warning for excess and insufficient temperature
 - Door alarm
 - No-volt remote alarm contact for connection to a remote alarm system
- RS 485 port
- Self-closing and lockable door
- Door hinges on right, changeable
- Door seal changeable
- 5 adjustable grid inserts in tilt-resistant guide rails
- Interior made of stainless steel CNS
- 4 castors, 2 lockable

Forced Air Circulation



LabStar Sirius LSSI 7505EWU (With accessories Inventory Systems. See sep. brochure.)

Model LabStar Sirius	LSSI 5005	LSSI 5005	LSSI 5030	LSSI 5025
Version	EWU/EEU	GEWU/GEEU Glass door	EWU/EEU	GEWU/GEEU Glass door
Temperature range	°C: +1/+10		-10/-30	-10/-23
Content litres (gross):	515	523	515	523
Content litres (net):	348	354	348	354
Ext. dimensions (WxDxH)	mm: 620x860x1997		620x860x1997	620x860x1997
Int. dimensions (WxDxH)	mm: 500x685x1505		500x685x1505	500x685x1505
Depth with door opened	mm: 1440		1440	1440
Grid inserts	:5		5	5
Weight	kgs: 106		114	114
Mains connection	: < 1/N/PE ~ 230 V 50-60 Hz >			
Shipping dimensions (WxDxH)	mm: 700x880x2200		700x880x2200	700x880x2200
Shipping weight	kgs: 117		125	125
Refrigerant CFC- and HCFC-free	:R134a		R134a	R290

LabStar Sirius + Accessories:	Outside / Inside	Cat. No.
LabStar Sirius LSSI 5005EWU	white / CNS	GSLSSI5005EWU
LabStar Sirius LSSI 5005EEU	CNS / CNS	GSLSSI5005EEU
LabStar Sirius LSSI 5005GEWU	white, glass door / CNS	GSLSSI5005GEWU
LabStar Sirius LSSI 5005GEEU	CNS, glass door / CNS	GSLSSI5005GEEU
LabStar Sirius LSSI 5030EWU	white / CNS	GSLSSI5030EWU
LabStar Sirius LSSI 5030EEU	CNS / CNS	GSLSSI5030EEU
LabStar Sirius LSSI 5025GEWU	white, glass door / CNS	GSLSSI5025GEWU
LabStar Sirius LSSI 5025GEEU	CNS, glass door / CNS	GSLSSI5025GEEU

- ProfiTec Temperature Monitoring and Recording System (see sep. brochure). **GPTEC4A**
- ProfiCaller telephone dialler (see sep. brochure). **on request**
- Pt-100 temperature sensor, add. installed for ext. temperature recording. **ZXX2-020-2L**
- Grid inserts, 430x655 mm (WxD). **ZLSSI4-430x655**
- Guide rails for grid inserts (1 pair). **ZLSSI4-024**
- Drawer with telescopic slide-out for LSSI 50xx, made of CNS. **ZLSSI4-001**
- Interior socket, tropical design. **ZLSSI1-001-01**
- Feet instead of castors, made of CNS (50 mm height adjustable). **ZLSSI5-021-125**
- Duct to storage compartment 26 mm in diameter. **ZLSSI1-002-26**
- Door hinges factory-mounted on left. **ZLSSI5-001**
- MIN/MAX thermometer to be placed in refrigerators or freezers. **ZXX2-019-001**
- Measuring range -50/+50 °C, an add. temperature sensor is not required. **on request**
- MIN/MAX digital thermometer. Hand-held unit with digital display as well as data-hold and relative measuring function. Measuring range -200/+1370 °C. **ZXX2-019-011**
- An add. temperature sensor is required, eg. Cat.-No. ZXX2-022-100. **ZXX2-022-100**
- Temperature sensor for MIN/MAX thermometer ZXX2-019-011. **ZXX2-022-100**
- Measuring range -100/+1000 °C. Length 2 m. Other ranges on request.

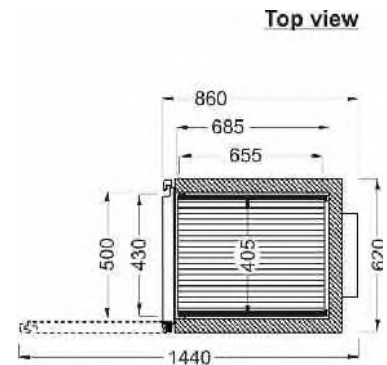

Side view

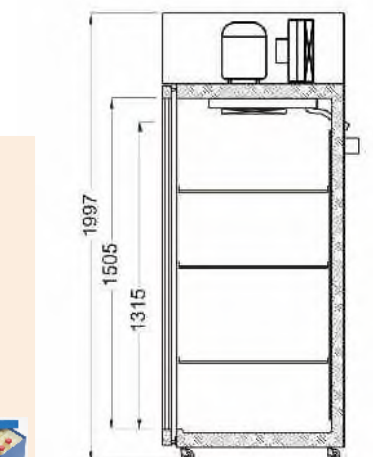

Inventory Systems

Stainless steel racks, freezer cassettes and grid inserts enable specimens to be stored and retrieved in a clear and orderly manner. Optimum use is made of the storage capacity.

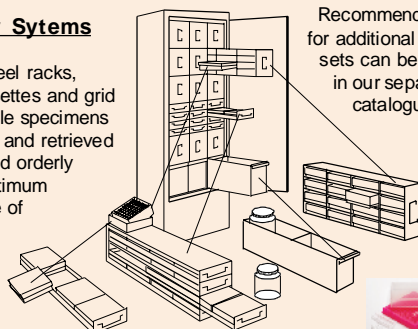

Recommendations for additional storage sets can be found in our separate catalogue.



Please ask for a personal fitting option.



National Lab GmbH
 Grambacher Weg 157
 D-23879 Mölln
 Tel.: +49 45 42 / 84 91 - 70
 Fax: +49 45 42 / 84 91 - 71
 e-Mail: LabSales@NationalLab.com

Laboratory Refrigerator and Upright Freezer LabStar Sirius

- Forced air circulation with automatic defrost and condensate evaporation
- Cooling unit top
- Operating panel with main switch
 - Electronic control with digital display
 - Visual/audible alarm device
 - Alarm warning for excess and insufficient temperature
 - Door alarm
 - No-volt remote alarm contact for connection to a remote alarm system
- RS 485 port
- Self-closing and lockable door
- Door hinges on right, changeable
- Door seal changeable
- 3 adjustable grid inserts in tilt-resistant guide rails
- Interior made of stainless steel CNS
- 4 castors, 2 lockable

Forced Air Circulation



LabStar Sirius LSSI 7505EWU (With accessories Inventory Systems. See sep. brochure.)

Model LabStar Sirius	LSSI 7505	LSSI 7505	LSSI 7530	LSSI 7525
Version	EWU/EEU	GEWU/GEEU Glass door	EWU/EEU	GEWU/GEEU Glass door
Temperature range	°C: +1/+10	+1/+10	-10/-30	-10/-23
Content litres (gross):	618	627	618	627
Content litres (net):	435	441	435	441
Ext. dimensions (WxDxH)	mm: 720x860x1997	720x860x1997	720x860x1997	720x860x1997
Int. dimensions (WxDxH)	mm: 600x685x1505	600x695x1505	600x685x1505	600x695x1505
Depth with door opened	mm: 1540	1540	1540	1540
Grid inserts	:3	3	3	3
Weight	kgs: 117	117	121	121
Mains connection	:	< 1/N/PE ~ 230 V 50-60 Hz >		
Shipping dimensions (WxDxH)	mm: 800x900x2200	800x900x2200	800x900x2200	800x900x2200
Shipping weight	kgs: 129	129	133	133
Refrigerant CFC- and HCFC-free	:R134a	R134a	R290	R290

LabStar Sirius + Accessories:	Outside/ Inside	Cat. No.
LabStar Sirius LSSI 7505EWU	white / CNS	GSLSSI7505EWU
LabStar Sirius LSSI 7505EEU	CNS / CNS	GSLSSI7505EEU
LabStar Sirius LSSI 7505GEWU	white, glass door / CNS	GSLSSI7505GEWU
LabStar Sirius LSSI 7505GEEU	CNS, glass door / CNS	GSLSSI7505GEEU
LabStar Sirius LSSI 7530EWU	white / CNS	GSLSSI7530EWU
LabStar Sirius LSSI 7530EEU	CNS / CNS	GSLSSI7530EEU
LabStar Sirius LSSI 7525GEWU	white, glass door / CNS	GSLSSI7525GEWU
LabStar Sirius LSSI 7525GEEU	CNS, glass door / CNS	GSLSSI7525GEEU

- ProfiTec Temperature Monitoring and Recording System (see sep. brochure). GPTEC4A
- ProfiCaller telephone dialler (see sep. brochure). on request
- Pt-100 temperature sensor, add. installed for ext. temperature recording. ZXX2-020-2L
- Grid inserts, 530x655 mm (WxD). ZLSSI4-530x655
- Guide rails for grid inserts (1 pair). ZLSSI4-024
- Drawer with telescopic slide-out for LSSI 75xx, made of CNS. ZLSSI4-002
- Interior socket, tropical design. ZLSSI1-001-01
- Feet instead of castors, made of CNS (50 mm height adjustable). ZLSSI5-021-125
- Duct to storage compartment 26 mm in diameter. ZLSSI1-002-26
- Door hinges factory-mounted on left. ZLSSI5-001
- MIN/MAX thermometer to be placed in refrigerators or freezers. ZXX2-019-001
- Measuring range -50/+50 °C, an add. temperature sensor is not required. on request
- MIN/MAX digital thermometer. Hand-held unit with digital display as well as data-hold and relative measuring function. Measuring range -200/+1370 °C. ZXX2-019-011
- An add. temperature sensor is required, eg. Cat.-No. ZXX2-022-100. ZXX2-022-100
- Temperature sensor for MIN/MAX thermometer ZXX2-019-011. ZXX2-022-100
- Measuring range -100/+1000 °C. Length 2 m. Other ranges on request.

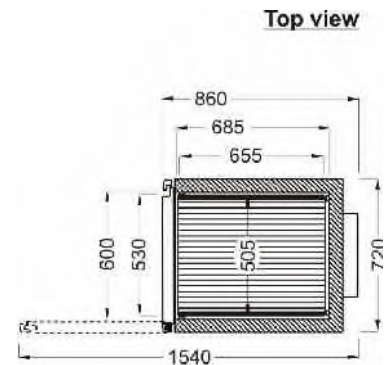

Top view

Side view

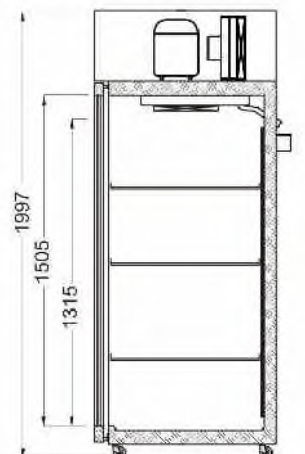

Inventory Systems

Stainless steel racks, freezer cassettes and grid inserts enable specimens to be stored and retrieved in a clear and orderly manner. Optimum use is made of the storage capacity.

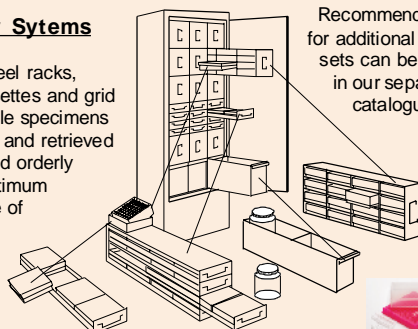

Recommendations for additional storage sets can be found in our separate catalogue.



Please ask for a personal fitting option.



National Lab GmbH
 Grambacher Weg 157
 D-23879 Mölln
 Tel.: +49 45 42 / 84 91 - 70
 Fax: +49 45 42 / 84 91 - 71
 e-Mail: LabSales@NationalLab.com

Laboratory Refrigerator and Upright Freezer LabStar Sirius

- Forced air circulation with automatic defrost and condensate evaporation
- Cooling unit top
- Operating panel with main switch
 - Electronic control with digital display
 - Visual/audible alarm device
 - Alarm warning for excess and insufficient temperature
 - Door alarm
 - No-volt remote alarm contact for connection to a remote alarm system
- RS 485 port
- Self-closing and lockable doors
- Door seal changeable
- 6 adjustable grid inserts in tilt-resistant guide rails
- Interior made of stainless steel CNS
- 5 castors, 3 lockable



LabStar Sirius LSSI 14005EUW
(With accessories Inventory Systems. See sep. brochure.)

Model LabStar Sirius	LSSI 14005	LSSI 14005	LSSI 14030	LSSI 14025
Version	EWU/EEU	GEWU/GEEU Glass door	EWU/EEU	GEWU/GEEU Glass door
Temperature range	°C: +1/+10	+1/+10	-10/-30	-10/-23
Content litres (gross):	1360	1380	1360	1380
Content litres (net):	870	883	870	883
Ext. dimensions (WxDxH) mm:	1440x860x1997	1440x860x1997	1440x860x1997	1440x860x1997
Int. dimensions (WxDxH) mm:	1320x685x1505	1320x695x1505	1320x685x1505	1320x695x1505
Depth with door opened mm:	1540	1540	1540	1540
Grid inserts	:6	6	6	6
Weight kgs:	178	178	188	188
Mains connection	:	< 1/N/PE ~ 230 V 50-60 Hz >		
Shipping dimen. (WxDxH) mm:	1520x900x2200	1520x900x2200	1520x900x2200	1520x900x2200
Shipping weight kgs:	195	195	205	205
Refrigerant CFC- / HCFC-free :	R134a	R134a	R290	R290

LabStar Sirius + Accessories:	Outside / Inside	Cat. No.
LabStar Sirius LSSI 14005EUW	white / CNS	GSLSSI14005EUW
LabStar Sirius LSSI 14005EEU	CNS / CNS	GSLSSI14005EEU
LabStar Sirius LSSI 14005GEWU	white, glass door / CNS	GSLSSI14005GEWU
LabStar Sirius LSSI 14005GEEU	CNS, glass door / CNS	GSLSSI14005GEEU
LabStar Sirius LSSI 14030EUW	white / CNS	GSLSSI14030EUW
LabStar Sirius LSSI 14030EEU	CNS / CNS	GSLSSI14030EEU
LabStar Sirius LSSI 14025GEWU	white, glass door / CNS	GSLSSI14025GEWU
LabStar Sirius LSSI 14025GEEU	CNS, glass door / CNS	GSLSSI14025GEEU

- ProfiTec Temperature Monitoring and Recording System (see sep. brochure) GPTEC4A
- ProfiCaller telephone dialler (see sep. brochure) on request
- Pt-100 temperature sensor, add. installed for ext. temperature recording. ZXX2-020-2L
- Grid inserts, 530x655 mm (WxD). ZLSSI4-530x655
- Guide rails for grid inserts (1 pair). ZLSSI4-024
- Drawer with telescopic slide-out for LSSI 140xx, made of CNS. ZLSSI4-002
- Interior socket, tropical design. ZLSSI1-001-01
- Feet instead of castors, made of CNS (50 mm height adjustable). ZLSSI5-021-125
- Duct to storage compartment 26 mm in diameter. ZLSSI1-002-26
- MIN/MAX thermometer to be placed in refrigerators or freezers. ZXX2-019-001
- Measuring range -50/+50 °C, an add. temperature sensor is not required.
- MIN/MAX digital thermometer. Hand-held unit with digital display as well as data-hold and relative measuring function. Measuring range -200/+1370 °C. ZXX2-019-011
- An add. temperature sensor is required, eg. Cat.-No. ZXX2-022-100.
- Temperature sensor for MIN/MAX thermometer ZXX2-019-011. ZXX2-022-100
- Measuring range -100/+1000 °C. Length 2 m. Other ranges on request.

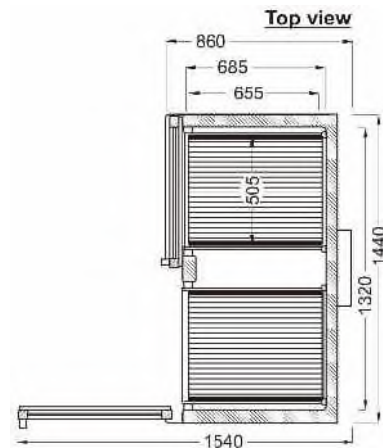

side view

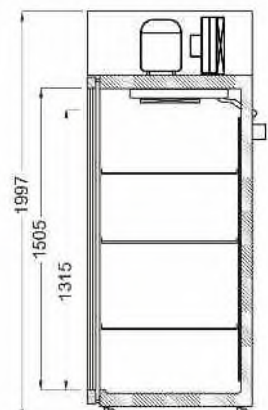

Inventory Systems

Stainless steel racks, freezer cassettes and grid inserts enable specimens to be stored and retrieved in a clear and orderly manner. Optimum use is made of the storage capacity.

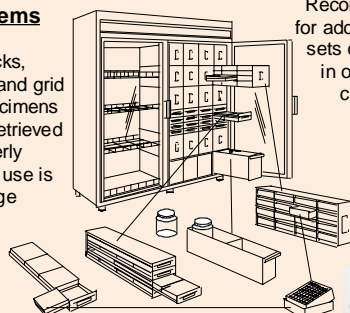

Recommendations for additional storage sets can be found in our separate catalogue.



Please ask for a personal fitting option.



Laboratory Refrigerator and Upright Freezer LabStar Sirius

- Static cooling with automatic defrost and condensate evaporation
- Cooling unit top
- Operating panel with main switch
 - Electronic control with digital display
 - Visual/audible alarm device
 - Alarm warning for excess and insufficient temperature
 - Door alarm
 - No-volt remote alarm contact for connection to a remote alarm system
- RS 485 port
- Self-closing and lockable door
- Door hinges on right, changeable
- Door seal changeable
- 3 adjustable grid inserts in tilt-resistant guide rails
- Interior made of stainless steel CNS
- 4 castors, 2 lockable



LabStar Sirius LSSI 3505GEWU

Model LabStar Sirius	LSSI 3505	LSSI 3505
Version	EWN/EEN	GEWN/GEEN Glass door
Temperature range	°C: +1/+10	+1/+10
Content litres (gross):	346	346
Content litres (net):	227	227
Ext. dimensions (WxDxH) mm:	520x700x1997	520x700x1997
Int. dimensions (WxDxH) mm:	400x575x1505	400x575x1505
Depth with door opened mm:	1182	1182
Grid inserts	3	3
Weight kgs:	98	98
Mains connection	< 1/N/PE ~ 230 V 50 Hz >	
Shipping dimensions (WxDxH) mm:	610x840x2200	610x840x2200
Shipping weight kgs:	112	112
Refrigerant CFC- and HCFC-free	R134a	R134a

LabStar Sirius + Accessories:	Outside / Inside	Cat. No.
LabStar Sirius LSSI 3505EWN	white / CNS	GSLSSI3505EWN
LabStar Sirius LSSI 3505EEN	CNS / CNS	GSLSSI3505EEN
LabStar Sirius LSSI 3505GEWN	white, glass door / CNS	GSLSSI3505GEWN
LabStar Sirius LSSI 3505GEEN	CNS, glass door / CNS	GSLSSI3505GEEN

- ProfiTec Temperature Monitoring and Recording System (see sep. brochure). GPTEC4A
- ProfiCaller telephone dialler (see sep. brochure). on request
- Pt-100 temperature sensor, add. installed for ext. temperature recording. ZXX2-020-2L
- Ex-Version „Interior free of ignition sources.“ ZLSSI1-070
- Grid inserts, 330x545 mm (WxD). ZLSSI4-330x545
- Guide rails for grid inserts (1 pair). ZLSSI4-023
- Drawer with telescopic slide-out for LSSI 35xx, made of CNS. ZLSSI4-003
- Interior socket, tropical design. ZLSSI1-001-01
- Feet instead of castors, made of CNS (50 mm height adjustable). ZLSSI5-021-125
- Duct to storage compartment 26 mm in diameter. ZLSSI1-002-26
- MIN/MAX thermometer to be placed in refrigerators or freezers. ZXX2-019-001
- Measuring range -50/+50 °C, an add. temperature sensor is not required.
- MIN/MAX digital thermometer. Hand-held unit with digital display as well as data-hold and relative measuring function. Measuring range -200/+1370 °C. ZXX2-019-011
- An add. temperature sensor is required, eg. Cat.-No. ZXX2-022-100.
- Temperature sensor for MIN/MAX thermometer ZXX2-019-011. ZXX2-022-100
- Measuring range -100/+1000 °C. Length 2 m. Other ranges on request.

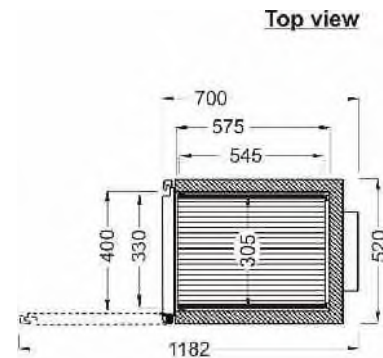

Side view

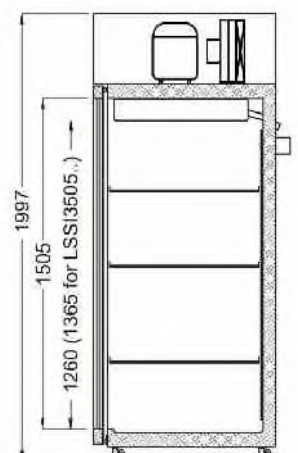

Inventory Systems

Stainless steel racks, freezer cassettes and grid inserts enable specimens to be stored and retrieved in a clear and orderly manner. Optimum use is made of the storage capacity.

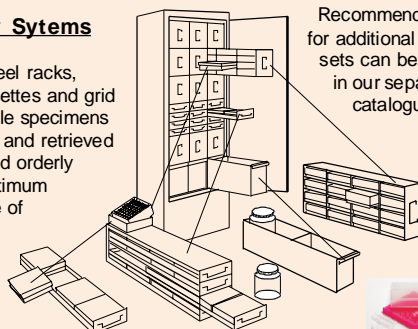

Please ask for a personal fitting option.



Laboratory Refrigerator and Upright Freezer LabStar Sirius

- Static cooling with automatic defrost and condensate evaporation
- Cooling unit top
- Operating panel with main switch
 - Electronic control with digital display
 - Visual/audible alarm device
 - Alarm warning for excess and insufficient temperature
 - Door alarm
- No-volt remote alarm contact for connection to a remote alarm system
- RS 485 port
- Self-closing and lockable door
- Door hinges on right, changeable
- Door seal changeable
- 5 adjustable grid inserts in tilt-resistant guide rails
- Interior made of stainless steel CNS
- 4 castors, 2 lockable

Static Cooling



LabStar Sirius LSSI 7505EWN
(With accessories Inventory Systems. See sep. brochure.)

Model LabStar Sirius	LSSI 5005	LSSI 5005
Version	EWN/EEN	GEWN/GEEN
		Glass door
Temperature range	°C: +1/+10	+1/+10
Content	litres (gross): 515	523
Content	litres (net): 362	367
Ext. dimensions (WxDxH)	mm: 620x860x1997	620x860x1997
Int. dimensions (WxDxH)	mm: 500x685x1505	500x695x1505
Depth with door opened	mm: 1440	1440
Grid inserts	: 5	5
Weight	kgs: 106	106
Mains connection	: < 1/N/PE ~ 230 V 50 Hz >	
Shipping dimensions (WxDxH)	mm: 700x880x2200	700x880x2200
Shipping weight	kgs: 117	117
Refrigerant CFC- and HCFC-free	: R134a	R134a

LabStar Sirius + Accessories:	Outside / Inside	Cat. No.
LabStar Sirius LSSI 5005EWN	white / CNS	GSLSSI5005EWN
LabStar Sirius LSSI 5005EEN	CNS / CNS	GSLSSI5005EEN
LabStar Sirius LSSI 5005GEWN	white, glass door / CNS	GSLSSI5005GEWN
LabStar Sirius LSSI 5005GEEN	CNS, glass door / CNS	GSLSSI5005GEEN

- ProfiTec Temperature Monitoring and Recording System (see sep. brochure). **GPTEC4A**
- ProfiCaller telephone dialler (see sep. brochure). **on request**
- Pt-100 temperature sensor, add. installed for ext. temperature recording. **ZXX2-020-2L**
- Ex-Version „Interior free of ignition sources.“ **ZLSSI1-070**
- Grid inserts, 430x655 mm (WxD). **ZLSSI4-430x655**
- Guide rails for grid inserts (1 pair). **ZLSSI4-024**
- Drawer with telescopic slide-out for LSSI 50xx, made of CNS. **ZLSSI4-001**
- Interior socket, tropical design. **ZLSSI1-001-01**
- Feet instead of castors, made of CNS (50 mm height adjustable). **ZLSSI5-021-125**
- Duct to storage compartment 26 mm in diameter. **ZLSSI1-002-26**
- Door hinges factory-mounted on left. **ZLSSI5-001**
- MIN/MAX thermometer to be placed in refrigerators or freezers. **ZXX2-019-001**
- Measuring range -50/+50 °C, an add. temperature sensor is not required. **on request**
- MIN/MAX digital thermometer. Hand-held unit with digital display as well as data-hold and relative measuring function. Measuring range -200/+1370 °C. **ZXX2-019-011**
- An add. temperature sensor is required, eg. Cat.-No. ZXX2-022-100. **ZXX2-022-100**
- Temperature sensor for MIN/MAX thermometer ZXX2-019-011. **ZXX2-022-100**
- Measuring range -100/+1000 °C. Length 2 m. Other ranges on request.

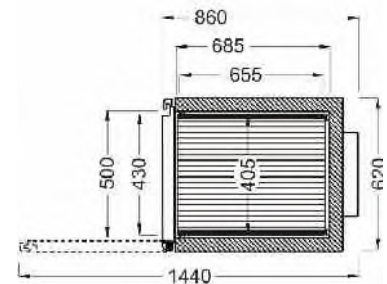

Top view

Side view

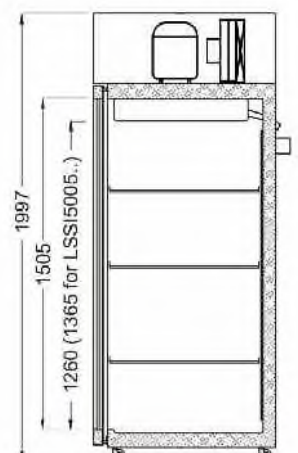

Inventory Systems

Stainless steel racks, freezer cassettes and grid inserts enable specimens to be stored and retrieved in a clear and orderly manner. Optimum use is made of the storage capacity.

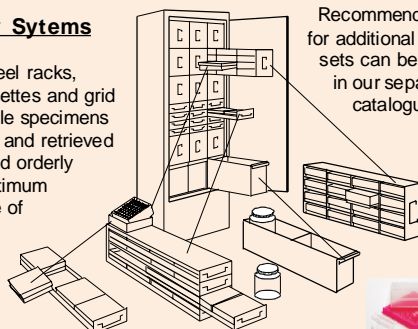

Recommendations for additional storage sets can be found in our separate catalogue.



Please ask for a personal fitting option.



Laboratory Refrigerator and Upright Freezer LabStar Sirius

- Static cooling with automatic defrost and condensate evaporation
- Cooling unit top
- Operating panel with main switch
 - Electronic control with digital display
 - Visual/audible alarm device
 - Alarm warning for excess and insufficient temperature
 - Door alarm
- No-volt remote alarm contact for connection to a remote alarm system
- RS 485 port
- Self-closing and lockable door
- Door hinges on right, changeable
- Door seal changeable
- 3 adjustable grid inserts in tilt-resistant guide rails
- Interior made of stainless steel CNS
- 4 castors, 2 lockable

Static Cooling



LabStar Sirius LSSI 7505EWN (With accessories Inventory Systems. See sep. brochure.)

Model LabStar Sirius	LSSI 7505	LSSI 7505
Version	EWN/EEN	GEWN/GEEN
		Glass door
Temperature range	°C: +1/+10	+1/+10
Content	litres (gross): 618	627
Content	litres (net): 451	458
Ext. dimensions (WxDxH)	mm: 720x860x1997	720x860x1997
Int. dimensions (WxDxH)	mm: 600x685x1505	600x695x1505
Depth with door opened	mm: 1540	1540
Grid inserts	: 3	3
Weight	kgs: 117	117
Mains connection	: < 1/N/PE ~ 230 V 50 Hz >	
Shipping dimensions (WxDxH)	mm: 800x900x2200	800x900x2200
Shipping weight	kgs: 129	129
Refrigerant CFC- and HCFC-free	: R134a	R134a

LabStar Sirius + Accessories:	Outside/ Inside	Cat. No.
LabStar Sirius LSSI 7505EWN	white / CNS	GSLSSI7505EWN
LabStar Sirius LSSI 7505EEN	CNS / CNS	GSLSSI7505EEN
LabStar Sirius LSSI 7505GEWN	white, glass door / CNS	GSLSSI7505GEWN
LabStar Sirius LSSI 7505GEEN	CNS, glass door / CNS	GSLSSI7505GEEN

ProfiTec Temperature Monitoring and Recording System (see sep. brochure).
 ProfiCaller telephone dialler (see sep. brochure).
 Pt-100 temperature sensor, add. installed for ext. temperature recording.
 Ex-Version „Interior free of ignition sources.“
 Grid inserts, 530x655 mm (WxD).
 Guide rails for grid inserts (1 pair).
 Drawer with telescopic slide-out for LSSI 75xx, made of CNS.
 Interior socket, tropical design.
 Feet instead of castors, made of CNS (50 mm height adjustable).
 Duct to storage compartment 26 mm in diameter.
 Door hinges factory-mounted on left.
 MIN/MAX thermometer to be placed in refrigerators or freezers.
 Measuring range -50/+50 °C, an add. temperature sensor is not required.
 MIN/MAX digital thermometer. Hand-held unit with digital display as well as data-hold and relative measuring function. Measuring range -200/+1370 °C.
 An add. temperature sensor is required, eg. Cat.-No. ZXX2-022-100.
 Temperature sensor for MIN/MAX thermometer ZXX2-019-011.
 Measuring range -100/+1000 °C. Length 2 m. Other ranges on request.

GPTEC4A

on request

ZXX2-020-2L

ZLSSI1-070

ZLSSI4-530x655

ZLSSI4-024

ZLSSI4-002

ZLSSI1-001-01

ZLSSI5-021-125

ZLSSI1-002-26

ZLSSI5-001

ZXX2-019-001

ZXX2-019-011

ZXX2-022-100

Top view

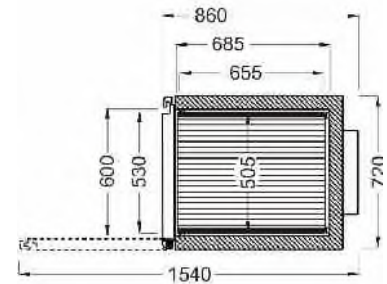

Side view

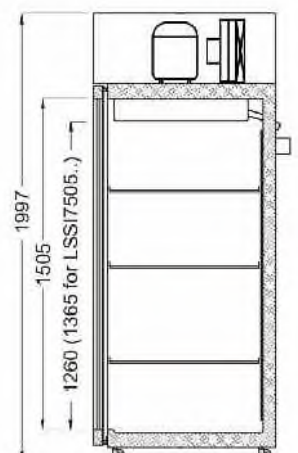

Inventory Systems

Stainless steel racks, freezer cassettes and grid inserts enable specimens to be stored and retrieved in a clear and orderly manner. Optimum use is made of the storage capacity.

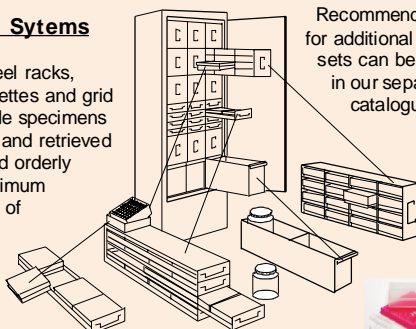

Recommendations for additional storage sets can be found in our separate catalogue.



Please ask for a personal fitting option.



Laboratory Refrigerator and Upright Freezer LabStar Sirius

- Static cooling with automatic defrost and condensate evaporation
- Cooling unit top
- Operating panel with main switch
 - Electronic control with digital display
 - Visual/audible alarm device
 - Alarm warning for excess and insufficient temperature
 - Door alarm
- No-volt remote alarm contact for connection to a remote alarm system
- RS 485 port
- Self-closing and lockable doors
- Door seal changeable
- 6 adjustable grid inserts in tilt-resistant guide rails
- Interior made of stainless steel CNS
- 5 castors, 3 lockable

Static Cooling



LabStar Sirius LSSI 14005EWN
(With accessories Inventory Systems. See sep. brochure.)

Model LabStar Sirius	LSSI 14005	LSSI 14005
Version	EWN/EEN	GEWN/GEEN
		Glass door
Temperature range	°C: +1/+10	+1/+10
Content	litres (gross): 1360	1380
Content	litres (net): 903	917
Ext. dimensions (WxDxH)	mm: 1440x860x1997	1440x860x1997
Int. dimensions (WxDxH)	mm: 1320x685x1505	1320x695x1505
Depth with door opened	mm: 1540	1540
Grid inserts	: 6	6
Weight	kgs: 178	178
Mains connection	: < 1/N/PE ~ 230 V 50 Hz >	
Shipping dimen. (WxDxH)	mm: 1520x900x2200	1520x900x2200
Shipping weight	kgs: 195	195
Refrigerant CFC- / HCFC-free	: R134a	R134a

LabStar Sirius + Accessories:	Outside / Inside	Cat. No.
LabStar Sirius LSSI 14005EWN	white / CNS	GSLSSI14005EWN
LabStar Sirius LSSI 14005EEN	CNS / CNS	GSLSSI14005EEN
LabStar Sirius LSSI 14005GEWN	white, glass door / CNS	GSLSSI14005GEWN
LabStar Sirius LSSI 14005GEEN	CNS, glass door / CNS	GSLSSI14005GEEN

- ProfiTec Temperature Monitoring and Recording System (see sep. brochure). **GPTEC4A**
- ProfiCaller telephone dialler (see sep. brochure). **on request**
- Pt-100 temperature sensor, add. installed for ext. temperature recording. **ZXX2-020-2L**
- Ex-Version „Interior free of ignition sources.“ **ZLSSI1-070**
- Grid inserts, 530x655 mm (WxD). **ZLSSI4-530x655**
- Guide rails for grid inserts (1 pair). **ZLSSI4-024**
- Drawer with telescopic slide-out for LSSI 140xx, made of CNS. **ZLSSI4-002**
- Interior socket, tropical design. **ZLSSI1-001-01**
- Feet instead of castors, made of CNS (50 mm height adjustable). **ZLSSI5-021-125**
- Duct to storage compartment 26 mm in diameter. **ZLSSI1-002-26**
- MIN/MAX thermometer to be placed in refrigerators or freezers. **ZXX2-019-001**
- Measuring range -50/+50 °C, an add. temperature sensor is not required.
- MIN/MAX digital thermometer. Hand-held unit with digital display as well as data-hold and relative measuring function. Measuring range -200/+1370 °C. **ZXX2-019-011**
- An add. temperature sensor is required, eg. Cat.-No. ZXX2-022-100.
- Temperature sensor for MIN/MAX thermometer ZXX2-019-011. **ZXX2-022-100**
- Measuring range -100/+1000 °C. Length 2 m. Other ranges on request.

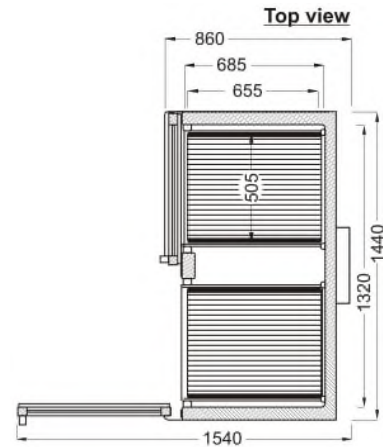

side view

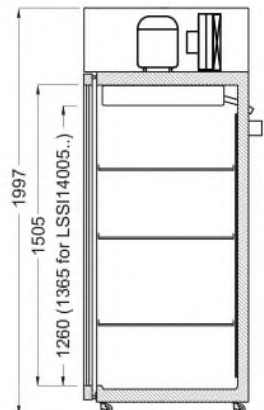

Inventory Systems

Stainless steel racks, freezer cassettes and grid inserts enable specimens to be stored and retrieved in a clear and orderly manner. Optimum use is made of the storage capacity.

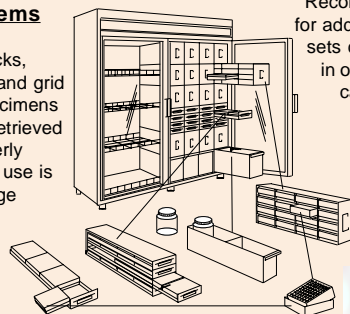

Recommendations for additional storage sets can be found in our separate catalogue.

Please ask for a personal fitting option.

Bloodbank Refrigerator LabStar Sanguis LSSA

- Forced air circulation , automatic defrost and condensate evaporation
- Micro-processor driven temperature controller
 - Visual/audible alarm device, mains-independent
 - Alarm warning for excess and insufficient temperature
 - Power failure alarm
 - Probe failure alarm
 - Door alarm
 - Integrated data logger
 - USB port for data download
 - Circular chart recorder for 7 days
- No-volt remote alarm contact for connection to a remote alarm system
- External housing made of white corrosion-resistant, galvanized steel plate with PVC finish
 - Self-closing and lockable door
 - Door hinges on right, changeable
 - Door seal changeable
 - 2 drawers with telescopic slide-out
 - Interior made of stainless steel CNS
 - Interior lighting
 - 4 castors, 2 height adjustable feet at rear



LabStar Sanguis LSSA1104GEWU

Model LabStar Sanguis LSSA1104GEWU

Temperature range	°C:	+2/+6
Content	litres (gross):	100
Ext. dimensions (WxDxH)	mm:	600x600x850
Int. dimensions (WxDxH)	mm:	475x440x460
Depth with door opened	mm:	1135
Drawers	:	2
Number of blood bags à 450 ml	:	64
Weight	kgs:	80
Mains connection	:	1/N/PE ~ 230 V 50 Hz
Shipping dimensions (WxDxH)	mm:	680x680x1050
Shipping weight	kgs:	91
Refrigerant CFC- and HCFC-free	:	R134a

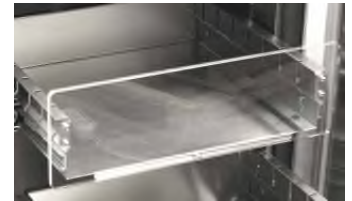

drawer with telescopic slide-out

LabStar Sanguis + Accessories: Outside / Inside Cat. No.

LabStar Sanguis LSSA1104GEWU	white, glass door / CNS	GSLSSA1104GEWU
ProfiTec Temperature Monitoring and Recording System (see sep. brochure).		GPTEC4A
ProfiCaller telephone dialler (see sep. brochure).		on request
Pt-100 temperature sensor, add. installed for ext. temperature recording.		ZXX2-020-2L
SMS alarm (to 5 mobile numbers maximum).		on request
7-day circular charts. Pck. of 100 pieces.		on request
Internal dividers for drawer. 1 set consisting of 3 dividers.		ZLSSA4-010
MIN/MAX thermometer to be placed in refrigerators or freezers.		ZXX2-019-001
Measuring range -50/+50 °C, an add. temperature sensor is not required.		
MIN/MAX digital thermometer. Hand-held unit with digital display as well as data-hold and relative measuring function. Measuring range -200/+1370 °C.		ZXX2-019-011
An add. temperature sensor is required, eg. Cat.-No. ZXX2-022-100.		
Temperature sensor for MIN/MAX thermometer ZXX2-019-011.		ZXX2-022-100
Measuring range -100/+1000 °C. Length 2 m. Other ranges on request.		
Export version with special voltages / frequencies.		on request

ProfiTec Intelligent Temperature Monitoring and Recording System



- For up to 4 refrigerators and/or freezers
- Readings are stored over a period up to 781 days
- Warning for excess and insufficient temperature
- Includes No-volt remote alarm contact
- The measuring protocol can be fed to PC via RS 232 port

Inventory Systems

Stainless steel racks, freezer cassettes and grid inserts enable specimens to be stored and retrieved in a clear and orderly manner. Optimum use is made of the storage capacity.

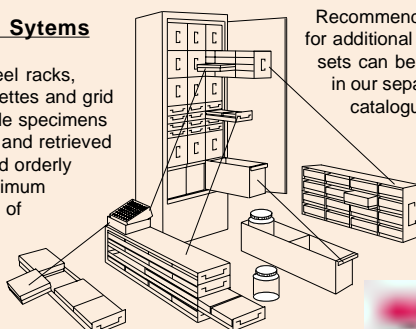

Recommendations for additional storage sets can be found in our separate catalogue.

Please ask for a personal fitting option.



MIN/MAX digital thermometer with add. temperature sensor

Bloodbank Refrigerator LabStar Sirius LSSI

- Forced air circulation with automatic defrost and condensate evaporation
- Cooling unit top
- Operating panel with main switch
 - Electronic control with digital display
 - Visual/audible alarm device, mains-independent
 - Alarm warning for excess and insufficient temperature
 - Door alarm
 - No-volt remote alarm contact for connection to a remote alarm system
 - RS 485 port
- Self-closing and lockable door(s)
- Door hinges on right, changeable (for models with one door)
- Door seal changeable
- 7 drawers with telescopic slide-out and dividers (14 at LSSI 14004.); can be factory-fitted with 8 drawers if required (16 at LSSI 14004.)
- Interior made of stainless steel CNS
- Interior lighting
- 4 castors, 2 lockable, (LSSI 14004.. with 5 castors, 3 lockable)



LabStar Sirius LSSI 7504GEWU

Model LabStar Sirius	LSSI 5004	LSSI 7504	LSSI 14004
Version	GEWU/GEEU	GEWU/GEEU	GEWU/GEEU
Temperature range	°C: +4	+4	+4
Content	litres (gross): 525	630	1255
Ext.dimensions (WxDxH)	mm: 620x860x1997	720x860x1997	1440x860x1997
Int.dimensions (WxDxH)	mm: 500x695x1505	600x695x1505	1320x695x1505
Depth with door opened	mm: 1440	1540	1540
Telescopic drawers	: 7	7	14
Doors	: 1	1	2
Weight	kgs: 105	112	178
Mains connection	:	< 1/N/PE ~ 230 V 50 Hz >	
Shipping dimensions (WxDxH)	mm: 700x880x2200	800x900x2200	1540x900x2200
Shipping weight	kgs: 115	122	195
Refrigerant CFC- and HCFC-free	: R134a	R134a	R134a



drawer with telescopic slide-out, made of CNS



individually partitionable telescopic drawers

LabStar Sirius + Accessories: Outside / Inside Cat. No.

LabStar Sirius LSSI 5004GEWU	white, glass door / CNS	GSLSSI5004GEWU
LabStar Sirius LSSI 5004GEEU	CNS, glass door / CNS	GSLSSI5004GEEU
LabStar Sirius LSSI 7504GEWU	white, glass door / CNS	GSLSSI7504GEWU
LabStar Sirius LSSI 7504GEEU	CNS, glass door / CNS	GSLSSI7504GEEU
LabStar Sirius LSSI 14004GEWU	white, glass door / CNS	GSLSSI14004GEWU
LabStar Sirius LSSI 14004GEEU	CNS, glass door / CNS	GSLSSI14004GEEU

ProfiTec Temperature Monitoring and Recording System (see sep. brochure) GPTEC4A

ProfiCaller telephone dialler (see sep. brochure) on request

Pt-100 temperature sensor, add. installed for ext. temperature recording. ZXX2-020-2L

Circular chart recorder for 7 days. ZLSSI2-031-040

6" 7-day circular charts. Pck. of 100 pieces. on request

Drawer with telescopic slide-out for LSSI 50xx, made of CNS. ZLSSI4-001

Drawer with telescopic slide-out for LSSI 75xx and LSSI 140xx, CNS. ZLSSI4-002

Interior socket, tropical design. ZLSSI1-001-01

Feet instead of castors, made of CNS (50 mm height adjustable). ZLSSI5-021-125

Duct to storage compartment 26 mm in diameter. ZLSSI1-002-26

Door hinges factory-mounted on left. ZLSSI5-001

MIN/MAX thermometer to be placed in refrigerators or freezers. ZXX2-019-001

Measuring range -50/+50 °C, an add. temperature sensor is not required.

MIN/MAX digital thermometer. Hand-held unit with digital display as well as ZXX2-019-011

data-hold and relative measuring function. Measuring range -200/+1370 °C.

An add. temperature sensor is required, eg. Cat.-No. ZXX2-022-100.

Temperature sensor for MIN/MAX thermometer ZXX2-019-011. ZXX2-022-100

Measuring range -100/+1000 °C. Length 2 m. Other ranges on request.

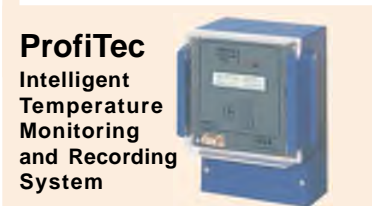

ProfiTec
Intelligent
Temperature
Monitoring
and Recording
System

- For up to 4 refrigerators and/or freezers
- Readings are stored over a period up to 781 days
- Warning for excess and insufficient temperature
- Includes No-volt remote alarm contact
- The measuring protocol can be fed to PC via RS 232 port



Plasma Storage Cabinet ProfiFrost PFU / PF

- Static cooling and manual defrost
- Maintenance-free cooling system
- Low-noise and low-vibration fully hermetic compressor, air-cooled
- Operating panel with micro-processor driven temperature controller and graphic display in separate upright housing (can be positioned as per customer requirements)
- Visual/audible alarm device
 - Mains-independent
 - Alarm warning for excess and insufficient temperature
 - No-volt remote alarm contact for connection to a remote alarm system
 - RS 485 port
- Data logger for recording events (temperature change, exceeding limits, alarms triggered).
- External housing made of white, galvanized steel plate
- Freeze-proof special seal
- Lockable door (PFU14.. only, others on request)
- Door hinges on right, changeable
- Interior with closed removable plastic drawers (PFU14.. with 1 additional storage basket. PF27.. with 2 additional compartments above.)
- Feet made of plastic (PVC) (at PF27.. front feet of cabinet allow for height adjustment, two castors at rear)



ProfiFrost PFU1447WN **

Model ProfiFrost		PFU0833WN	PFU0841WN	PFU1433WN	PFU1447WN	PF2728WN	PF2747WN
Temperature range	°C:	-16/-30	-16/-40	-14/-30	-14/-45	-16/-28	-16/-45
Content	litres gross:	70	70	143	143	241	241
Ext. dimensions (WxDxH)*	mm:	555x624x630	555x680x630	600x615x830	600x615x830	600x650x1700	600x650x1700
Depth with door opened	mm:	1165	1260	1215	1215	1140	1140
Number of drawers/compartments	:	2/0	2/0	3/1	3/1	5/2	5/2
Weight	kgs:	31	31	45	45	73	73
Mains connection	:	< 1/N/PE ~ 220-230 V 50 Hz >		< 1/N/PE ~ 220-230 V 50 Hz >		< 1/N/PE ~ 220-230 V 50 Hz >	
Shipping dimensions (WxDxH)	mm:	700x750x790	700x750x790	700x750x990	700x750x990	700x750x1860	700x750x1860
Shipping weight	kgs:	40	40	54	54	83	83
Refrigerant CFC- and HCFC-free	:	R600a	R507	R600a	R507	R600a	R507

* Positioning the upright housing¹⁾ with the operating panel on the cabinet increases the height by 90 mm.
The flexible connecting lead allows the unit to be positioned as per customer requirements.



ProfiFrost PF2733WN **

Model	Outside / Inside	Cat. No.
ProfiFrost PFU0833WN	white / white	GSPFU0833WN
ProfiFrost PFU0841WN	white / white	GSPFU0841WN
ProfiFrost PFU1433WN	white / white	GSPFU1433WN
ProfiFrost PFU1447WN	white / white	GSPFU1447WN
ProfiFrost PF2728WN	white / white	GSPF2728WN
ProfiFrost PF2747WN	white / white	GSPF2747WN

Accessories	Cat. No.
ProfiTec Temperature Monitoring and Recording System (see sep. brochure).	GPTEC4A
ProfiCaller telephone dialler (see sep. brochure).	on request
Pt-100 temperature sensor, add. installed for ext. temperature recording.	ZPM2-023-2L
Ex-Version „Interior free of ignition sources.“	ZPF1-070
Transport carriage with 4 castors (2 lockable).	ZPFU5-021
Door lock, factory mounted PFU08.. and PF27.. only).	on request



Temperature controller with graphic display and data logger

** The arrangement system (cryoboxes, etc.) that can be seen in the plasma storage cabinets is optional. See our separate catalogue for Inventory Systems.



Model No.	ML0906WN	ML1306WN	ML2725WN	ML3225WN
Temperature range	Fridge: +2 °C to +10 °C Freezer: -6 °C to -9 °C	Fridge: +2 °C to 10 °C Freezer: -18 °C to -25 °C	Fridge: +2 °C to 10 °C Freezer: -18 °C to -25 °C	Fridge: +2 °C to 10 °C Freezer: -18 °C to -25 °C
Forced air circulation	No	No	No	No
Defrost (automatic / manual)	Fridge: automatic Freezer: manual	Fridge: automatic Freezer: manual	Fridge: automatic Freezer: manual	Fridge: automatic Freezer: manual
Electronic controller	No	Yes	Yes	Yes
Digital display	No	Yes	Yes	Yes
Temperature alarm visual / audible	Yes	Yes	Yes	Yes
Excess and insufficient temp. alarm	Yes	Yes	Yes	Yes
Open door alarm	No	Yes	Yes	Yes
No-volt remote alarm	No	Yes	Yes	Yes
External finish	Painted steel plate	Painted steel plate	Painted steel plate	Painted steel plate
Colour	White	White	White	White
Lock	Yes	Yes	Yes (2)	Yes (2)
Door type	Solid door	Solid door	Solid door	Solid door
Door hinges	Changeable	Changeable	Changeable	Changeable
Door seal	Not changeable	Not changeable	Not changeable	Not changeable
Internal finish	Plastic, white	Plastic, white	Plastic, white	Plastic, white
Interior light	No	No	No	No
Spark free	Yes	Yes	Yes	Yes
Interior fittings Fridge				
• Shelves (number)	2	2	3	3
• Shelf positions (number)	2	4	6	6
• Shelf size (mm) (WxDxH)	438x274x6 438x137x6	1: 448x308x4.5 1: 448x200x4.5	448x308x4.5	505x320x6
• Drawers (number)	0	1	2 half	2 half
• Wire baskets (number)	1	0	0	0
• Adjustable door bins (number)	0	2 full and 2 half	2 full and 2 half	2 full and 4 half
• Optional drawer system	Yes	Yes	Yes	Yes
Interior fittings Freezer				
• Drawers (number)	0	0	2 and 1 flap	2 and 2 flaps
Adjustable feet (number & position)	2 front feet 2 rear rollers	2 front feet 2 rear rollers	2 front feet 2 fixed rear	2 front feet 2 rear rollers
Gross capacity (l)	83.5	119	263	324
Net capacity (l)	74.2	106	159	190
External width (mm)	502	540	540	600
External depth (mm)	540	600	600	600
Door open depth (mm)	976	1090	1110	1190
External height (mm)	660	860	1680	1870
Internal dimensions (mm) (DxWxH)	415x370x540	Fridge: 450x450x525 Freezer: 400x295x120 step (TxH): 155x225	Fridge: 457x450x725 Freezer: 408x415x670 step (TxH): 170x220	Fridge: 510x430x805 Freezer: 463x445x780 step (TxH): 250x260
Product weight (kg)	25	34	58	70
Voltage supply	1/N/PE~230V 50Hz	1/N/PE~230V 50Hz	1/N/PE~230V 50Hz	1/N/PE~230V 50Hz
Packed width (mm)	700	700	700	700
Packed depth (mm)	750	750	750	750
Packed height (mm)	825	1027	1850	2035
Packed weight (kg)	32	41	65	77
Refrigerant type CFC / HCFC free	R134a	R600a	R600a	R600a



ML1306WN



ML1306WN with Inventory System (optional)



ML2725WN



ML3225WN

Recommendations for additional storage sets can be found in our separate catalogue. Please ask for a personal fitting option.

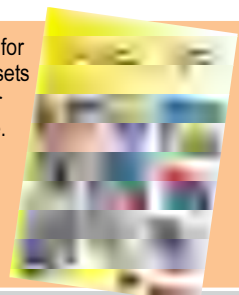

Refrigerator/Freezer Combination LabStar Sirius LSSI

- Forced air circulation for refrigerator and freezer with automatic defrost and condensate evaporation
- 2 separate cooling circuits for refrigerator and freezer
- Cooling unit top
- 2 operating panels with:
 - Main switch
 - Electronic control with digital display
 - Visual/audible alarm device
 - Alarm warning for excess and insufficient temperature
- Door alarm
- No-volt remote alarm contact for connection to a remote alarm system
- RS 485 port
- Self-closing and lockable doors
- Door hinges on right, changeable
- Door seal changeable
- 4 castors, 2 lockable
- 4 (2x2) adjustable grid inserts in tilt-resistant guide rails
- Interior made of stainless steel CNS



LabStar Sirius LSSI 3030KEEU

Model LabStar Sirius	LSSI 3030	LSSI 7030
Version	KEWU/KEEU	KEWU/KEEU
Refrigerator:		
Temperature range °C:	+1/+10	+1/+10
Content litres (gross):	160	290
Int. dimensions (WxDxH) mm:	400x560x700	600x685x700
Grid inserts :	2	2
Refrigerant CFC- and HCFC-free :	R134a	R134a
Freezer:		
Temperature range °C:	-10/-30	-10/-30
Content litres (gross):	160	290
Int. dimensions (WxDxH) mm:	400x560x700	600x685x700
Grid inserts :	2	2
Refrigerant CFC- and HCFC-free :	R290	R290
Ext. dimensions (WxDxH) mm:	520x700x1997	720x860x1997
Depth with door opened mm:	1182	1540
Weight kgs:	120	151
Mains connection :	1/N/PE ~ 230 V 50 Hz	1/N/PE ~ 230 V 50 Hz
Shipping dimensions (WxDxH) mm:	610x840x2200	800x900x2200
Shipping weight kgs:	130	163

ProfiTec Intelligent Temperature Monitoring and Recording System



- For up to 4 refrigerators and/or freezers
- Readings are stored over a period up to 781 days
- Warning for excess and insufficient temperature
- Includes No-volt remote alarm contact
- The measuring protocol can be fed to PC via RS 232 port

LabStar Sirius + Accessories:	Outside/ Inside	Cat. No.
LabStar Sirius LSSI 3030KEWU	white / CNS	GSLSSI3030KEWU
LabStar Sirius LSSI 3030KEEU	CNS / CNS	GSLSSI3030KEEU
LabStar Sirius LSSI 7030KEWU	white / CNS	GSLSSI7030KEWU
LabStar Sirius LSSI 7030KEEU	CNS / CNS	GSLSSI7030KEEU

ProfiTec Temperature Monitoring and Recording System (see sep. brochure). GPTEC4A

- ProfiCaller telephone dialler (see sep. brochure). on request
- Pt-100 temperature sensor, add. installed for ext. temperature recording. ZXX2-020-2L
- Grid inserts, 330x545 mm (WxD). ZLSSI4-330x545
- Grid inserts, 530x655 mm (WxD). ZLSSI4-530x655
- Guide rails for grid inserts LSSI 3030.. (1 pair). ZLSSI4-023
- Guide rails for grid inserts LSSI 7030.. (1 pair). ZLSSI4-024
- Drawer with telescopic slide-out for LSSI 3030.., made of CNS. ZLSSI4-003
- Drawer with telescopic slide-out for LSSI 7030.. made of CNS. ZLSSI4-002
- Interior socket, tropical design. ZLSSI1-001-01
- Feet instead of castors, made of CNS (50 mm height adjustable). ZLSSI5-021-125
- Duct to storage compartment 26 mm in diameter. ZLSSI1-002-26
- Door hinges factory-mounted on left. ZLSSI5-001
- MIN/MAX thermometer to be placed in refrigerators or freezers. ZXX2-019-001
- Measuring range -50/+50 °C, an add. temperature sensor is not required.
- MIN/MAX digital thermometer. Hand-held unit with digital display as well as data-hold and relative measuring function. Measuring range -200/+1370 °C. ZXX2-019-011
- An add. temperature sensor is required, eg. Cat.-No. ZXX2-022-100.
- Temperature sensor for MIN/MAX thermometer ZXX2-019-011. ZXX2-022-100
- Measuring range -100/+1000 °C. Length 2 m. Other ranges on request.

Please ask for a personal fitting option.

Recommendations for additional storage sets can be found in our separate catalogue.

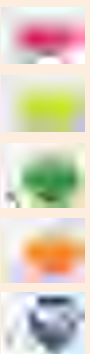

Small Scale Chest Freezer ProfiMaster *Mini* PMM

- Static cooling and manual defrost
- Low-noise refrigeration system, air-cooled
- Operating panel with electronic control and digital display (LED)
 - Visual/audible alarm device
 - Alarm warning for excess and insufficient temperature
 - No-volt remote alarm contact
- External housing made of stainless steel (CNS)
- Interior made of stainless steel (CNS)
- Insulated lid with hinge and magnetic seal



Small Scale Chest Freezer PMM0861EEN

Model ProfiMaster *Mini* PMM0861EEN

Temperature range	°C:	-20/-50
	:	Other temperature ranges available on request.
Content	litres (gross):	8
Ext. dimensions (WxDxH)	mm:	370x500x630
Int. dimensions (WxDxH)	mm:	140x275x200
Weight	kgs:	38
Mains connection	:	1/N/PE ~ 230 V 50 Hz
Refrigerant CFC- and HCFC-free:		Mix

Accessories

	Cat. No.
ProfiTec Temperature Monitoring and Recording System (see separate data sheet).	GPTEC4A
ProfiCaller telephone dialler.	on request
Pt-100 temperature sensor, add. installed for ext. temperature recording.	ZPM2-023-2L
Forced air circulation.	on request
MIN/MAX thermometer to be placed in refrigerators or freezers.	ZXX2-019-001
Measuring range -50/+50 °C, an add. temperature sensor is not required.	
MIN/MAX digital thermometer. Hand-held unit with digital display as well as data-hold and relative measuring function. Measuring range -200/+1370 °C.	ZXX2-019-011
An add. temperature sensor is required, eg. Cat.-No. ZXX2-022-100.	
Temperature sensor for MIN/MAX thermometer ZXX2-019-011.	ZXX2-022-100
Measuring range -100/+1000 °C. Length 2 m. Other ranges on request.	

ProfiTec Intelligent Temperature Monitoring and Recording System



- For up to 4 refrigerators and/or freezers
- Readings are stored over a period up to 781 days
- Warning for excess and insufficient temperature
- Includes No-volt remote alarm contact
- The measuring protocol can be fed to PC via RS 232 port



MIN/MAX digital thermometer with add. temperature sensor

Laboratory Upright Freezer ProfiLine Pegasus PLPE0186EWN



Temperature range	°C:	-40/-90
Content	litres (gross):	7
Ext. dimensions (WxDxH)	mm:	400x630x665
Int. dimensions (WxDxH)	mm:	150x143x310
Depth with door opened	mm:	960
Weight	kgs:	54
Mains connection	:	1/N/PE ~ 230 V 50-60 Hz

See separate data sheet.

Laboratory Chest Freezer ProfiLine Taurus PLTA

- Static cooling and manual defrost
- Most reliable and less complicated compressor technology, low-noise
- Micro-processor driven temperature controller with digital display
- Visual/audible alarm device
 - Alarm warning for excess and insufficient temperature
 - No-volt remote alarm contact
- External housing made of white, galvanized steel plate
- Interior made of white plastic
- Lockable lid and spring-loaded hinges to allow opening at any angle
- With castors, supplied separately (except for PLTA 0962 and PLTA 5562, see accessories)
- Storage baskets optional (see below)



Model ProfiLine Taurus	PLTA 0962	PLTA1462	PLTA 3362	PLTA 4362	PLTA 5562
Temperature range	°C: -30/-60	-30/-60	-30/-60	-30/-60	-30/-60
Temperature range -40 °C down to -86 °C see separate data sheet					
Content litres (gross):	74	133	296	383	532
Ext. dimensions (WxDxH) mm:	555x635x885	720x695x890	1260x695x890	1560x695x890	1705x655x865
Int. dimensions 1 (WxDxH) mm:	387x387x470	350x435x650	880x435x650	1190x435x650	1340x490x700
Int. dimensions 2 (WxDxH) mm:	—	200x435x400	200x435x400	200x435x400	200x490x450
Height at open top mm:	1480	1500	1500	1500	1540
Baskets optional (max. quantity) :	4 (type A)	4 (type B)	13 (type B)	16 (type B)	19 (type C)
Weight kgs:	53	55	76	88	107
Mains connection :	< 1/N/PE ~ 230 V 50-60 Hz >				
Shipping dimensions (WxDxH) mm:	750x700x1140	800x730x1040	1320x800x1040	1620x800x1040	1720x800x1200
Shipping weight kg:	63	66	91	103	131
Refrigerant :	Mix	Mix	Mix	Mix	Mix

Accessories

Accessories	Cat. No.
ProfiTec Temperature Monitoring and Recording System (see separate brochure).	GPTEC4A
ProfiCaller telephone dialler.	on request
Pt-100 temperature sensor, additionally installed for external temperature recording.	ZXX2-020-2L
CO ₂ back-up system, free-standing.	ZXX2-093
Facilities for customer connection of CO ₂ back-up system.	ZPLTA2-094
Ex-Version „Interior free of ignition sources.“	ZPLTA1-070
Transport carriage with 4 swivel castors (for PLTA 0962).	ZPLTA5-21-09xx
4 castors, 2 lockable (for PLTA 5562).	on request
Storage basket (type A), 192x384x190 mm (WxDxH).	ZXX4-084
Storage basket (type B), 220x430x200 mm (WxDxH).	ZXX4-085
Storage basket (type C), 220x480x215 mm (WxDxH).	ZXX4-093

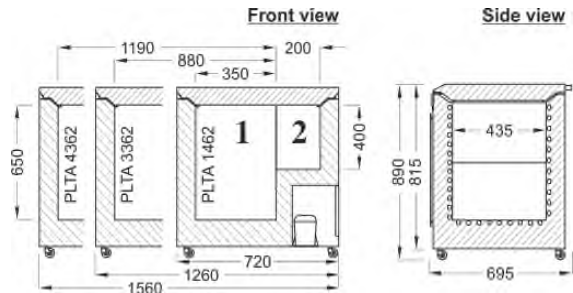

ProfiTec Intelligent Temperature Monitoring and Recording System

- For up to 4 refrigerators and/or freezers
- Readings are stored over a period up to 781 days
- Warning for excess and insufficient temperature
- Includes No-volt remote alarm contact
- Can be fed to PC via RS 232 port



Storage sets with matching vertical racks made of stainless steel



Number of racks when fully equipped

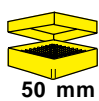

Type of box
ALPHA Box
BRAVO Box
EPPi® Box



Type of box
ALPHA Box
BRAVO Box
EPPi® Box

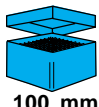

Type of box
ALPHA Box
BRAVO Box
EPPi® Box

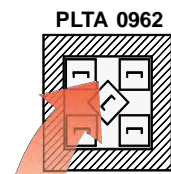

4 or 5

Type of box	Cat. No.
50 mm	TA50-08AN
50 mm	TE50-08AN
50 mm	TE50-08AN
75 mm	TA75-05AN
75 mm	TB75-05AN
75 mm	TE80-05AN
100 mm	TA100-04AN
100 mm	TE102-04AN
100 mm	TE102-04AN

PLTA 1462 on request

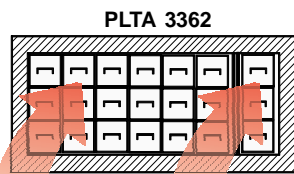

18

Type of box	Cat. No.
50 mm	TA50-11AN
50 mm	TE50-11AN
50 mm	TE50-11AN
75 mm	TA75-07AN
75 mm	TB75-07AN
75 mm	TE80-07AN
100 mm	TA100-03AN
100 mm	TE102-03AN
100 mm	TE102-03AN

on request

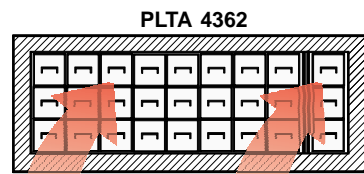

24

Type of box	Cat. No.
50 mm	TA50-11AN
50 mm	TE50-11AN
50 mm	TE50-11AN
75 mm	TA75-07AN
75 mm	TB75-07AN
75 mm	TE80-07AN
100 mm	TA100-03AN
100 mm	TE102-03AN
100 mm	TE102-03AN

on request

PLTA 5562 on request

www.NationalLab.com

National Lab GmbH
 Grambeker Weg 157
 D-23879 Moelln
 Tel.: +49 45 42 / 84 91 - 70
 Fax: +49 45 42 / 84 91 - 71
 e-Mail: LabSales@NationalLab.com

Laboratory Chest Freezer ProfiLine Taurus PLTA

- Static cooling and manual defrost
- Most reliable and less complicated compressor technology, low-noise
- Micro-processor driven temperature controller with digital display
- Visual/audible alarm device
 - Mains-independent
 - Alarm warning for excess and insufficient temperature
 - No-volt remote alarm contact
- RS 232 port
- Integrated data logger with USB port (models PLTA ..86 only)
- External housing made of white, galvanized steel plate
- Interior made of white plastic
- Inner lids
- Lockable lid and spring-loaded hinges to allow opening at any angle
- With castors, supplied separately (except for PLTA 09..., see accessories)
- Storage baskets optional (see below)



Model ProfiLine Taurus	PLTA 0986 ¹⁾	PLTA 2086 ¹⁾	PLTA 3386 ¹⁾	PLTA 4386 ¹⁾
	PLTA 0987 ²⁾	PLTA 2087 ²⁾	PLTA 3387 ²⁾	PLTA 4387 ²⁾
Temperature range	°C: -40/-86			
	Temperature range -30 °C down to -60 °C see separate data sheet			
Content litres (gross):	74	189	296	383
Ext. dimensions (WxDxH) mm:	555x635x885	920x695x890	1260x695x890	1560x695x890
Int. dimensions 1 (WxDxH) mm:	385x385x470(450 ³⁾)	545x435x650 (625 ³⁾)	880x435x650 (625 ³⁾)	1190x435x650 (625 ³⁾)
Int. dimensions 2 (WxDxH) mm:	—	200x435x400 (375 ³⁾)	200x435x400 (375 ³⁾)	200x435x400 (375 ³⁾)
Height at open top mm:	1480	1500	1500	1500
Baskets optional (max. quantity) :	4 (type A)	7 (type B)	13 (type B)	16 (type B)
Weight kgs:	53	64	88	98
Mains connection :	< 1/N/PE ~ 230 V 50-60 Hz >			
Shipping dimensions (WxDxH) mm:	680x640x1160	1016x756x1058	1355x755x1118	1655x755x1118
Shipping weight kg:	83	104	114	132
Refrigerant :	Mix	Mix	Mix	Mix

Accessories

Cat. No.

ProfiTec Temperature Monitoring and Recording System (see separate brochure).
ProfiCaller telephone dialler.

GPTEC4A

Pt-100 temperature sensor, additionally installed for external temperature recording.

on request
ZXX2-020-2L

CO₂ back-up system, free-standing.

ZXX2-093

Facilities for customer connection of CO₂ back-up system.

ZPLTA2-094

Ex-Version „Interior free of ignition sources.“

ZPLTA1-070

Transport carriage with 4 swivel castors (for PLTA 09...).

ZPLTA5-21-09xx

Storage basket (type A), 192x384x190 mm (WxDxH).

ZXX4-084

Storage basket (type B), 220x430x200 mm (WxDxH).

ZXX4-085

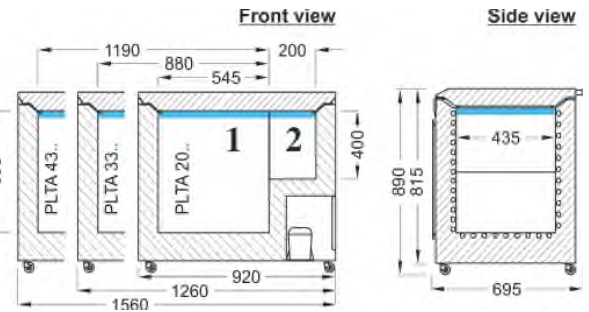

¹⁾ Models PLTA ..86 with integrated data logger.
²⁾ Models PLTA ..87 without integrated data logger.
³⁾ The heights in brackets apply when the supplied internal covers are used.

Storage sets with matching vertical racks made of stainless steel



Number of racks when fully equipped

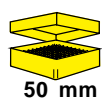

Type of box
ALPHA Box
BRAVO Box
EPPi® Box



ALPHA Box
BRAVO Box
EPPi® Box

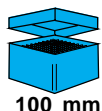

ALPHA Box
BRAVO Box
EPPi® Box



4 or 5

Cat. No.
TA50-08AN
TE50-08AN
TE50-08AN

PLTA 20.. on request

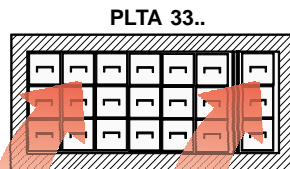

18

Cat. No.
TA50-11AN
TE50-11AN
TE50-11AN

3

Cat. No.
TA50-06AN
TE50-06AN
TE50-06AN

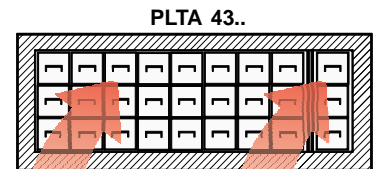

24

Cat. No.
TA50-11AN
TE50-11AN
TE50-11AN

3

Cat. No.
TA50-06AN
TE50-06AN
TE50-06AN

TA75-07AN
TB75-07AN
TE80-07AN

4

TA75-04AN
TB75-04AN
TE80-04AN

TA75-07AN
TB75-07AN
TE80-07AN

4

TA75-04AN
TB75-04AN
TE80-04AN

TA100-03AN
TE102-03AN
TE102-03AN

3

TA100-03AN
TE102-03AN
TE102-03AN

TA100-03AN
TE102-03AN
TE102-03AN

3

TA100-03AN
TE102-03AN
TE102-03AN

Chest Freezer ProfiLine Ultimus PLULC

- Static cooling and manual defrost (optional with forced air circulation)
- Micro-processor driven temperature controller with digital display and password protection
 - Visual/audible alarm device, mains-independent
 - Alarm warning for excess and insufficient temperature
 - Power failure alarm
 - Probe failure alarm
 - Condenser failure alarm
 - Low batterie alarm
 - Lid open alarm
 - No-volt remote alarm contact for connection to an alarm system on the premises
- External housing made of white, galvanized steel plate
- Lockable lid and spring-loaded hinges to allow opening at any angle
- Interior made of stainless steel CNS
- Inner lids
- 4 swivel castors



ProfiLine Ultimus PLULC33501

Model ProfiLine Ultimus PLULC17501EWN PLULC33501EWN PLULC48501EWN

Temperature range	°C: -35/-50	-35/-50	-35/-50
Content	litres (gross): 170	330	480
Ext. dimensions (WxDxH) mm:	900x1000x1240	1500x860x1240	1950x880x1120
Int. dimensions (WxDxH) mm:	630x490*x550	1240x490*x550	1220x520*x750
Height at open top	mm: 2125	1990	1900
Weight	kgs: 110	270	320
Mains connection	: 1/N/PE ~ 230 V 50 Hz	1/N/PE ~ 230 V 50 Hz	1/N/PE ~ 230 V 50 Hz
Shipping dim. (WxDxH) mm:	1100x1070x1730**	1700x930x1730**	2150x950x1610**
Shipping weight	kgs: -	-	-
Refrigerant CFC- and HCFC-free	: R404A	R404A	R404A

* Internal depth minus 50 mm when installing the forced air circulation.

** Information for delivery in wooden case (optional).

ProfiLine Ultimus chest freezers can be manufactured according to customers' requirements. Temperatures down to **-85 °C** are possible.



Option "forced air circulation"

ProfiLine Ultimus + Accessories:

Cat. No.

ProfiLine Ultimus PLULC17501EWN	GTPULC17501EWN
ProfiLine Ultimus PLULC33501EWN	GTPULC33501EWN
ProfiLine Ultimus PLULC48501EWN	GTPULC48501EWN

ProfiTec Temperature Monitoring and Recording System (see sep. brochure).	GPTEC4A
ProfiCaller telephone dialler (see sep. brochure).	on request
Pt-100 temperature sensor, additionally installed for external temperature recording.	ZXX2-020-2L
Forced air circulation.	ZPLUL9-001
Duct to storage compartment 28 mm in diameter.	ZPLUL1-001
Water-cooled version (water-cooled condenser).	on request
MIN/MAX thermometer to be placed in refrigerators or freezers.	ZXX2-019-001
Measuring range -50/+50 °C, an add. temperature sensor is not required.	
MIN/MAX digital thermometer. Hand-held unit with digital display as well as data-hold and relative measuring function. Measuring range -200/+1370 °C.	ZXX2-019-011
An add. temperature sensor is required, eg. Cat.-No. ZXX2-022-100.	
Temperature sensor for MIN/MAX thermometer ZXX2-019-011.	ZXX2-022-100
Measuring range -100/+1000 °C. Length 2 m. Other ranges on request.	

ProfiTec Intelligent Temperature Monitoring and Recording System



- For up to 4 refrigerators and/or freezers
- Readings are stored over a period up to 781 days
- Warning for excess and insufficient temperature
- Includes No-volt remote alarm contact
- The measuring protocol can be fed to PC via RS 232 port

Inventory Systems

Stainless steel vertical racks, freezer cassettes and grid inserts enable specimens to be stored and retrieved in a clear and orderly manner. Optimum use is made of the storage capacity. Storage systems are also available for this model in our separate brochures. You can also contact us for a personal consultation.

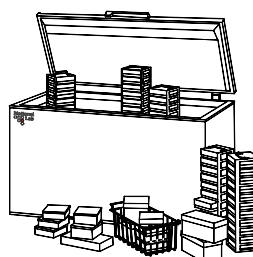

Please ask for a personal fitting option.

Recommendations for additional storage sets can be found in our separate catalogue.

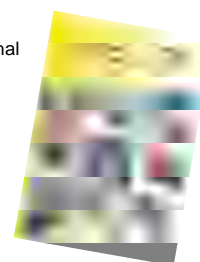

Laboratory Chest Freezer LabStar Mira LSMI

- Static cooling and manual defrost
- Operating panel with thermostat and visual alarm (optional: electronic control with digital display and alarm device)
- External housing made of white, galvanized steel plate
- Interior made of aluminium
- Condensate drain integrated in base
- Lockable lid and spring-loaded hinges to allow opening at any angle
- Interior lighting (except for ex-version)



Model LabStar Mira LSMI	2225WN	3525WN	4525WN	5325WN	6125WN	7125WN
Temperature range standard °C:	-15/-25	-15/-25	-15/-25	-15/-25	-15/-25	-15/-25
- with option electronic control °C:	-10/-25	-10/-25	-10/-25	-10/-25	-10/-25	-10/-25
Content litres (gross) l:	215	347	447	527	607	701
External dimensions mm:						
A	720	1050	1300	1500	1700	1800
B	730	730	730	730	730	770
C	650	650	650	650	650	690
D	860	860	860	860	860	860
E	1560	1560	1560	1560	1560	1600
Internal dimensions mm:						
F	600	930	1180	1380	1580	1680
G	400	730	980	1180	1380	1480
H	690	690	690	690	690	690
I	250	250	250	250	250	250
J	530	530	530	530	530	570
Storage baskets	1	2	2	3	3	3
Weight kgs:	43	54	64	67	77	85
Energy consumption kW/24h:	0.71	0.90	1.05	1.30	1.52	1.95
Mains connection	< 1/N/PE ~ 230 V 50 Hz >					
Shipping dimensions (WxDxH) mm:	770x750x930	1100x750x930	1350x750x930	1550x750x930	1750x750x930	1850x790x930
Shipping weight kgs:	50	60	70	75	80	90
Refrigerant CFC- and HCFC-free	R134a	R134a	R134a	R134a	R134a	R134a

LabStar Mira + Accessories:

	Cat. No.
LabStar Mira LSMI 2225WN	GTLSMI2225WN
LabStar Mira LSMI 3525WN	GTLSMI3525WN
LabStar Mira LSMI 4525WN	GTLSMI4525WN
LabStar Mira LSMI 5325WN	GTLSMI5325WN
LabStar Mira LSMI 6125WN	GTLSMI6125WN
LabStar Mira LSMI 7125WN	GTLSMI7125WN

- Alarm unit opt./acoust., electronic control with digital display and no-volt remote alarm contact. ZLSMI2-005+150/-55
- Digital temperature display incl. PTC temperature sensor. ZXX2-015-001
- Measuring range +50/-50 °C.
- ProfiTec Temperature Monitoring and Recording System (see sep. brochure). GPTEC4A
- ProfiCaller telephone dialler (see sep. brochure). on request
- Pt-100 temperature sensor, add. installed for ext. temperature recording. ZXX2-020-2L
- Ex-Version „Interior free of ignition sources.“ ZLSMI1-070
- Storage basket LSMI 2225 to LSMI 6125, 280x515x220 mm (WxDxH). ZXX4-089
- Storage basket LSMI 7125, 280x565x245 mm (WxDxH). ZXX4-090
- MIN/MAX digital thermometer. Hand-held unit with digital display as well as data-hold and relative measuring function. Measuring range -200/+1370 °C. ZXX2-019-011
- An add. temperature sensor is required, eg. Cat.-No. ZXX2-022-100.
- Temperature sensor for MIN/MAX thermometer ZXX2-019-011. ZXX2-022-100
- Measuring range -100/+1000 °C. Length 2 m. Other ranges on request.

Inventory Systems

Stainless steel vertical racks, freezer cassettes and grid inserts enable specimens to be stored and retrieved in a clear and orderly manner. Optimum use is made of the storage capacity. Storage systems are also available for this model in our separate brochures. You can also contact us for a personal consultation.

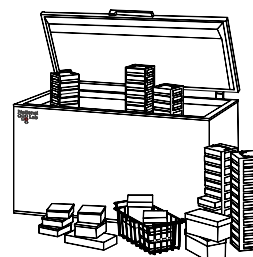

Side view

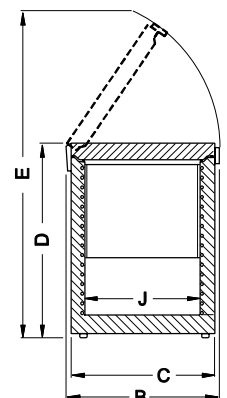

Front view

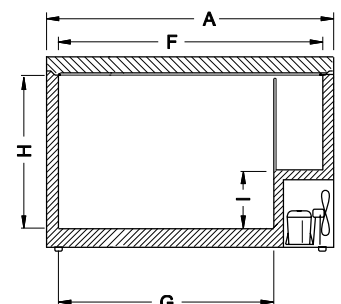

Laboratory Chest Freezer ProfiLine Pollux PLPO

- Static cooling and manual defrost
- Electronic control and digital display
 - Visual/audible alarm warning for excess and insufficient temperature
 - No-volt remote alarm contact for connection to a remote alarm system
- External housing made of white, galvanized steel plate
- Interior made of aluminium
- Condensate drain integrated in base
- Lockable lid and spring-loaded hinges to allow opening at any angle
- Interior lighting (except for ex-version)



ProfiLine Pollux 3645WN

Model ProfiLine Pollux	PLPO1345WN	PLPO2245WN	PLPO3045WN	PLPO3645WN	PLPO4245WN
Temperature range	°C: -5/-45	-5/-45	-5/-45	-5/-45	-5/-45
Content litres (gross):	130	226	299	358	416
Ext. dimensions (WxDxH)	mm: 725x731x865	1055x731x865	1305x731x865	1505x731x865	1705x731x865
Int. dimensions 1 (WxDxH)	mm:	< see sketch >			
Int. dimensions 2 (WxDxH)	mm:	< see sketch >			
Height at open top	mm: 1555	1555	1555	1555	1555
Weight	kgs: 43	54	64	67	77
Mains connection	:	< 1/N/PE ~ 230 V 50 Hz >			
Insulation CFC-free	mm: 100	100	100	100	100
Shipping dimensions (WxDxH)	mm: 825x831x1065	1155x831x1065	1405x831x1065	1605x831x1065	1805x831x1065
Shipping weight	kgs: 48	59	69	72	82
Refrigerant CFC- and HCFC-free	: R290	R290	R290	R290	R290

ProfiLine Pollux + Accessories:

	Cat. No.
ProfiLine Pollux PLPO 1345WN	GTPLO1345WN
ProfiLine Pollux PLPO 2245WN	GTPLO2245WN
ProfiLine Pollux PLPO 3045WN	GTPLO3045WN
ProfiLine Pollux PLPO 3645WN	GTPLO3645WN
ProfiLine Pollux PLPO 4245WN	GTPLO4245WN
ProfiTec Temperature Monitoring and Recording System (see sep. brochure).	GPTEC4A
ProfiCaller telephone dialler (see sep. brochure).	on request
Pt-100 temperature sensor, add. installed for ext. temperature recording.	ZXX2-020-2L
Ex-Version „Interior free of ignition sources.“	on request
4 castors (2 lockable), factory assembled.	ZPLPO5-022-4245
Storage basket, 285x445x250 mm (WxDxH).	ZXX4-087
MIN/MAX thermometer to be placed in refrigerators or freezers.	ZXX2-019-001
Measuring range -50/+50 °C, an add. temperature sensor is not required.	
MIN/MAX digital thermometer. Hand-held unit with digital display as well as data-hold and relative measuring function. Measuring range -200/+1370 °C.	ZXX2-019-011
An add. temperature sensor is required, eg. Cat.-No. ZXX2-022-100.	ZXX2-022-100
Temperature sensor for MIN/MAX thermometer ZXX2-019-011.	
Measuring range -100/+1000 °C. Length 2 m. Other ranges on request.	

Side view

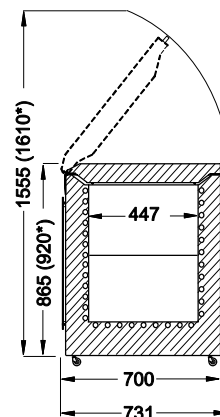

* Incl. castors

Front view

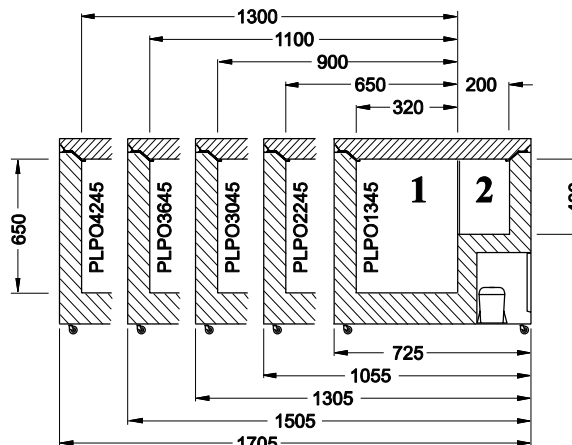

Inventory Systems

Stainless steel vertical racks, freezer cassettes and grid inserts enable specimens to be stored and retrieved in a clear and orderly manner. Optimum use is made of the storage capacity. Storage systems are also available for this model in our separate brochures. You can also contact us for a personal consultation.

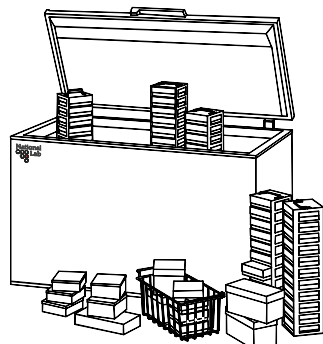

Temperature Monitoring and Recording System ProfiTec

Temperature monitoring and recording system for up to 4 refrigerators and freezers, ovens and incubators. Operating panel with digital display options for date, time, temperature of the 4 measuring stations, automatic adjustment from summer to winter time. The digital display is also used for programming. Measuring stations can be individually identified. Acoustic alarm device with individually adjustable warning levels and delay times. No-Volt remote alarm contact for connection to central control stations or telephone relaying. 3 signal inputs for door contact and/or system fault. Records up to 4 measuring stations simultaneously over a period of up to 781 days (5-minute intervals). Storage intervals selectable from 1 to 60 minutes. The readings are stored even in the event of a power failure. A rechargeable battery is available as an option and enables readings to be taken and stored even during a power cut. The measuring protocol can be read out directly on the instrument or PC via the RS 232 port (for software see Accessories). Up to 79 ProfiTec units can be linked within a network via the RS 485 port. The measuring protocols can then be called up individually with the PC. The casing is made of plastic with a transparent cover for the operating panel. Screws and a set of plugs are included for mounting the instrument on a wall.



ProfiTec 424A

Temperature monitoring range	°C: +600/-110
Resolution	°C: 0.5
Ambient temperature	°C: 0 to +50
External dimensions (WxDxH)	mm: 160x105x185
Power consumption	watts: 5
Measuring stations	: 4
Signal inputs	: 3 x 230 V with time delay
Storage capacity for readings	: 225,000
Interfaces	: RS 232 - serial port : RS 485 - PC network
Calibration	: factory preset, maintenance free
Protective system electrical	: IP 54
Mains connection	: 1/N/PE ~ 230 V 50-60 Hz

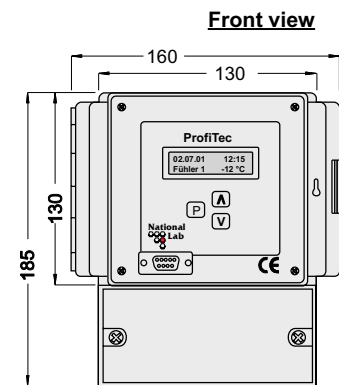

Front view

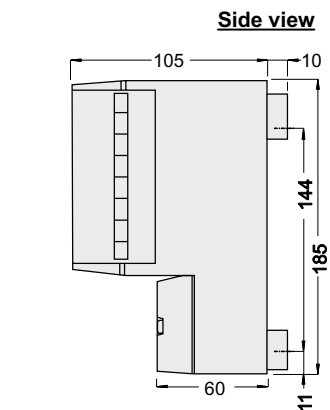

Side view

ProfiTec + Accessories:

Cat. No.

ProfiTec 424A	GPTEC4A
Temperature sensor with 6-m lead.	ZPTEC2-040-06
Temperature sensor with 12-m lead.	ZPTEC2-040-12
Temperature sensor with 30-m lead.	ZPTEC2-040-30
Temperature sensor with other lead.	on request
Set of rechargeable batteries 12V / 1.3 Ah.	ZPTEC2-041
and Printer (RS 232 port), 1.5 m long.	ZPTEC2-043
and PC (RS 232 port), 3 m long.	
Software for evaluation and recording for Windows.	ZPTEC2-042-XP
Digital converter for networking the ProfiTec units with a PC. With integrated power supply.	ZPTEC2-044-NT
Connection lead between ProfiTec and digital converter for networking (price per metre).	ZPTEC2-046
Converter USB 2.0 / RS 232.	ZPTEC2-044-RS232-USB

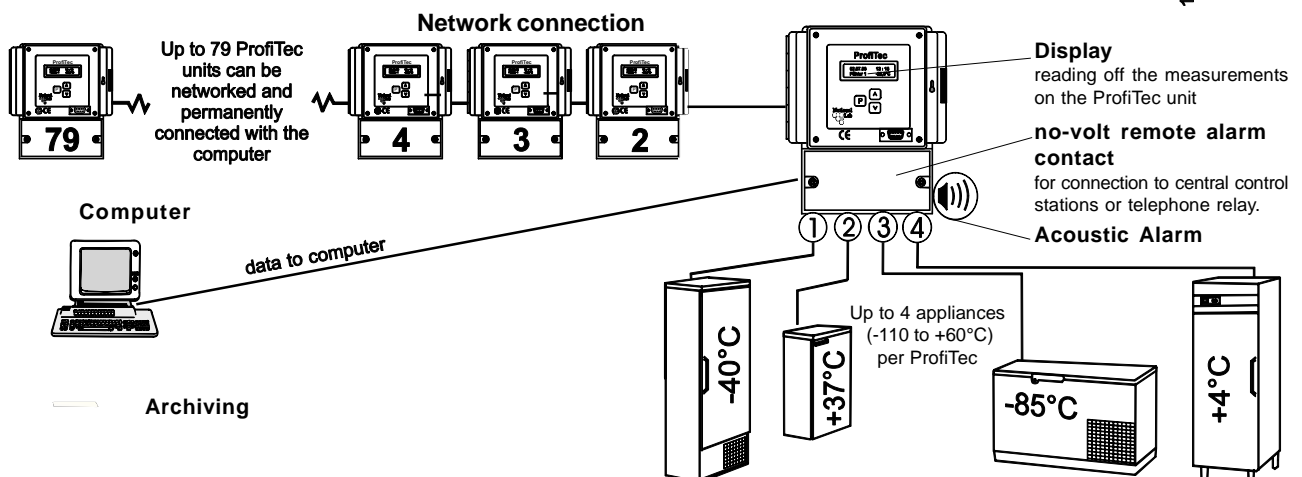

www.NationalLab.com



Tel.: +49 45 42 / 84 91 - 70
 Fax: +49 45 42 / 84 91 - 71
 e-Mail: LabSales@NationalLab.com

National Lab GmbH
 Grambeker Weg 157
 D-23879 Moelln

ProfiCool

Intelligent Recirculating Chillers



Recirculating Chillers ProfiCool *Minimus*

Air-cooled cooling unit with storage tank (in standard version open to atmosphere) and pump as well as electronic digital thermostat.

Model ProfiCool <i>Minimus</i>		PCMin 04.02	PCMin 06.02
Refrigerant	CFC-free	R134a	R134a
Cooling capacity at +20°C/+15°C	Watt	350/310	500/450
Operating range	°C	+5 / +25	+5 / +25
Pump capacity	l/min	12.5	12.5
Pump pressure	bar	0.75	0.75
Tank capacity	litre	7	7
Water connection (quick connection)		for hose 12 mm outside diameter	
Operating voltage	Ph/Volt/Hz	1/N/PE/230/50-60	1/N/PE/230/50-60
Weight	kg	22	25
Dimensions (WxDxH)	mm	413x283x415	413x283x415



Recirculating Chillers ProfiCool *Primus*

Air-cooled cooling unit with storage tank (in standard version open to atmosphere) and pump as well as electronic digital thermostat for temperature constancy ± 0.5 K.

Model ProfiCool <i>Primus</i>		PCPR 009	PCPR 013	PCPR 020
Refrigerant	CFC-free	R134a	R134a	R404a
Cooling capacity at +20°C/+15°C	kW	0.6 / 0.4	1.0 / 0.8	1.7 / 1.4
Operating range	°C	+5 / +30	+5 / +30	+5 / +30
Temperature constancy*	K	± 0.5	± 0.5	± 0.5
Rated coolant flow	m ³ /h	0.35	0.35	0.35
Pump pressure	bar	5.0	5.0	5.0
Tank capacity	litre	4	4	4
Water connection (quick connection)		for hose 12 mm outside diameter		
Operating voltage	Ph/Volt/Hz	1/N/PE/230/50-60	1/N/PE/230/50-60	1/N/PE/230/50-60
Weight	kg	35	42	48
Dimensions (WxDxH)	mm	235x520x625	235x520x625	235x520x625

* Temperature constancy optional available: ± 0.1 K

more units up to 10 kW available



Recirculating Chillers (19") ProfiCool *Exactus*

Air-cooled cooling unit as 19" rack with storage tank (in standard version open to atmosphere) and pump as well as electronic digital thermostat for temperature constancy ± 0.1 K.

Model ProfiCool <i>Exactus</i>		PCEX 014	PCEX 020	PCEX 055
Refrigerant	CFC-free	R134a	R404a	R404a
Cooling capacity at +20°C	kW	1.2	1.8	5.3
Operating range	°C	+15 / +30	+15 / +30	+15 / +30
Temperature constancy	K	± 0.1	± 0.1	± 0.1
Pump capacity	l/min	4-5	5-20	5-40
Pump pressure	bar	0-8	0.5-4	0.7-3.5
Tank capacity	litre	6	4.5	20
Water connection (plug connection)		for hose 12 mm outside diameter		¾" G
Operating voltage	Ph/Volt/Hz	1/N/PE/230/50-60	1/N/PE/230/50-60	3/PE/380-415/50 3/PE/460-480/60
Weight	kg	35	40	55
Dimensions (WxD)	mm	440x455	440x500	440x580
Height (1 rack unit = 44.5 mm)	RU	6	7.5	18



For all units we provide a wide range of options.
www.NationalLab.eu

ProfiCool

Intelligent Recirculating Chillers



Water-to-Water Heat Exchanger System FlowCool Unicus

Heat exchanger system without active refrigeration for connection to an "in-house cooling circuit". Exchanging system with storage tank (in standard version open to atmosphere) and pump as well as electronic digital thermostat for application cooling circuit.

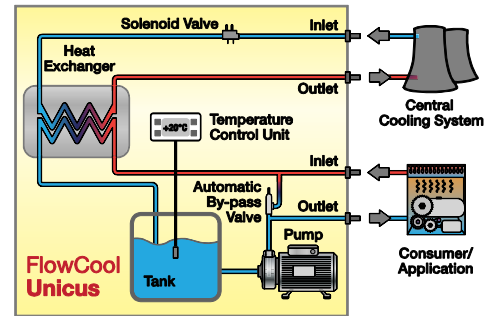

Model FlowCool Unicus		FCUN 001	FCUN 004	FCUN 006	FCUN 011
Cooling capacity	kW	1.3	3.8	6.5	11.5
Operating range cooling temperature	°C	+10/+50	+10/+50	+10/+50	+10/+50
Temperature constancy	K	±2	±2	±2	±2
Rated coolant flow	m³/h	0.2	0.7	1.1	2.0
Pump pressure	bar	2.9	2.9	4.2	2.3
Tank capacity	litre	10	10	10	10
Water connection		(hose olives) for hose 12 mm inside-Ø		Female R ½"	
Operating voltage	Ph/Volt/Hz	1/N/PE/230/50	1/N/PE/230/50	1/N/PE/230/50	1/N/PE/230/50
Weight	kg	19	22	32	33
Dimensions (WxDxH)	mm	230x520x650	445x575x540	445x575x540	445x575x540

Air-to-Water Heat Exchanger System AirCool Ventus

Heat exchanger system without active refrigeration for heat discharged into the ambient air. Application cooling circuit with storage tank (in standard version open to atmosphere) and pump as well as electronic digital thermostat.

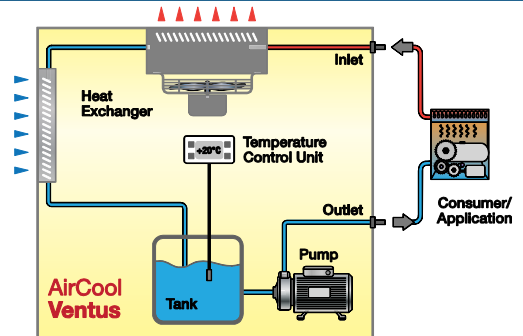

Model AirCool Ventus		ACVE 001	ACVE 002	ACVE 004
Cooling capacity at dT of 5K/20K	kW	0.8 / 3.2	1.3 / 5.2	3.9 / 15.6
Cooling medium		water	water	water
Rated coolant flow	m³/h	0.6	0.6	0.7
Pump pressure	bar	2.9	2.9	2.8
Tank capacity	litre	10	10	30
Water connection		(hose olives) for hose 12 mm inside-Ø		Female R ¾"
Required flow of cooling air	m³/h	880	800	2,100
Operating voltage	Ph/Volt/Hz	1/N/PE/230/50	1/N/PE/230/50	1/N/PE/230/50
Weight	kg	23	25	101
Dimensions (WxDxH)	mm	230x520x650	230x520x650	580x650x920



National Lab GmbH
Refrigeration Technology

Grambeker Weg 157
D-23879 Moelln

E-mail: _____

Distribution by:



EPPI® Box made of Polypropylene

130 x 130 mm

Selection from Catalogue



EPPI® 50 / 9x9 · height 52 mm fix.

Inner height 50 mm. 9x9 divider holds 81 vials up to 12.5 mm diameter. Without ID code. (See also page 8: KEA45)

Cat. No.	Colour	Cat. No.	Colour
KEA50-C81NA	natural	KEA50-C81YE	yellow
KEA50-C81NY	neon-yellow	KEA50-C81BU	blue
KEA50-C81NB	neon-blue	KEA50-C81GR	green
KEA50-C81NG	neon-green	KEA50-C81RE	red
KEA50-C81NP	neon-red/pink	KEA50-C81VT	violet
KEA50-C81NO	neon-orange	KEA50-C81BL	black
KEA50-C81WH	white	KEA50-C81BB	black/black*

*black/black: Lower half and lid black for light-sensitive samples

EPPI® 50 / 9x9 · height 52 mm fix.

Inner height 50 mm. 9x9 divider holds 81 vials up to 12.5 mm diameter. With alphanumeric ID code on all 4 sides. (See also page 8: KEB45)

Cat. No.	Colour	Cat. No.	Colour
KEB50-C81NA	natural	KEB50-C81YE	yellow
KEB50-C81NY	neon-yellow	KEB50-C81BU	blue
KEB50-C81NB	neon-blue	KEB50-C81GR	green
KEB50-C81NG	neon-green	KEB50-C81RE	red
KEB50-C81NP	neon-red/pink	KEB50-C81VT	violet
KEB50-C81NO	neon-orange	KEB50-C81BL	black
KEB50-C81WH	white	KEB50-C81BB	black/black*

*black/black: Lower half and lid black for light-sensitive samples

EPPI® 50 / 9x9 · height 52 mm fix.

Inner height 50 mm. 9x9 divider holds 81 vials up to 12.5 mm diameter. With alphanumeric ID code on all 4 sides as well as on the bottom of the box (transparent). (See also page 8: KEC45)

Cat. No.	Colour
KEC50-C81NA	natural
KEC50-C81NY	neon-yellow
KEC50-C81NB	neon-blue
KEC50-C81NG	neon-green
KEC50-C81NP	neon-red/pink
KEC50-C81NO	neon-orange

EPPI® 50 / 9x9 · height 52 mm fix.

Inner height 50 mm. 9x9 divider holds 81 vials up to 12.5 mm diameter. With alphanumeric ID code on all 4 sides as well as on the bottom of the box (transparent) and on the lid. (See also page 8: KEE45)

Cat. No.	Colour
KEE50-C81NA	natural
KEE50-C81NY	neon-yellow
KEE50-C81NB	neon-blue
KEE50-C81NG	neon-green
KEE50-C81NP	neon-red/pink
KEE50-C81NO	neon-orange

Nothing is impossible!

Well-organized freezers and refrigerators are an essential prerequisite for systematic, efficient and ultimately successful work – not only in scientific laboratories.

We provide the means to fulfil this prerequisite and devote ourselves to the task from a sense of conviction and with passion.

In fact, it is a passion for practical details and our liking for intelligent solutions.

This catalogue contains many suggestions for the interior fittings of all brands of refrigerator and freezer cabinets as well as freezer chests.

If you are looking for a solution to a problem or need assistance in setting up your refrigeration equipment, please contact us.

We will always be able to offer you a solution and will be glad to help you.

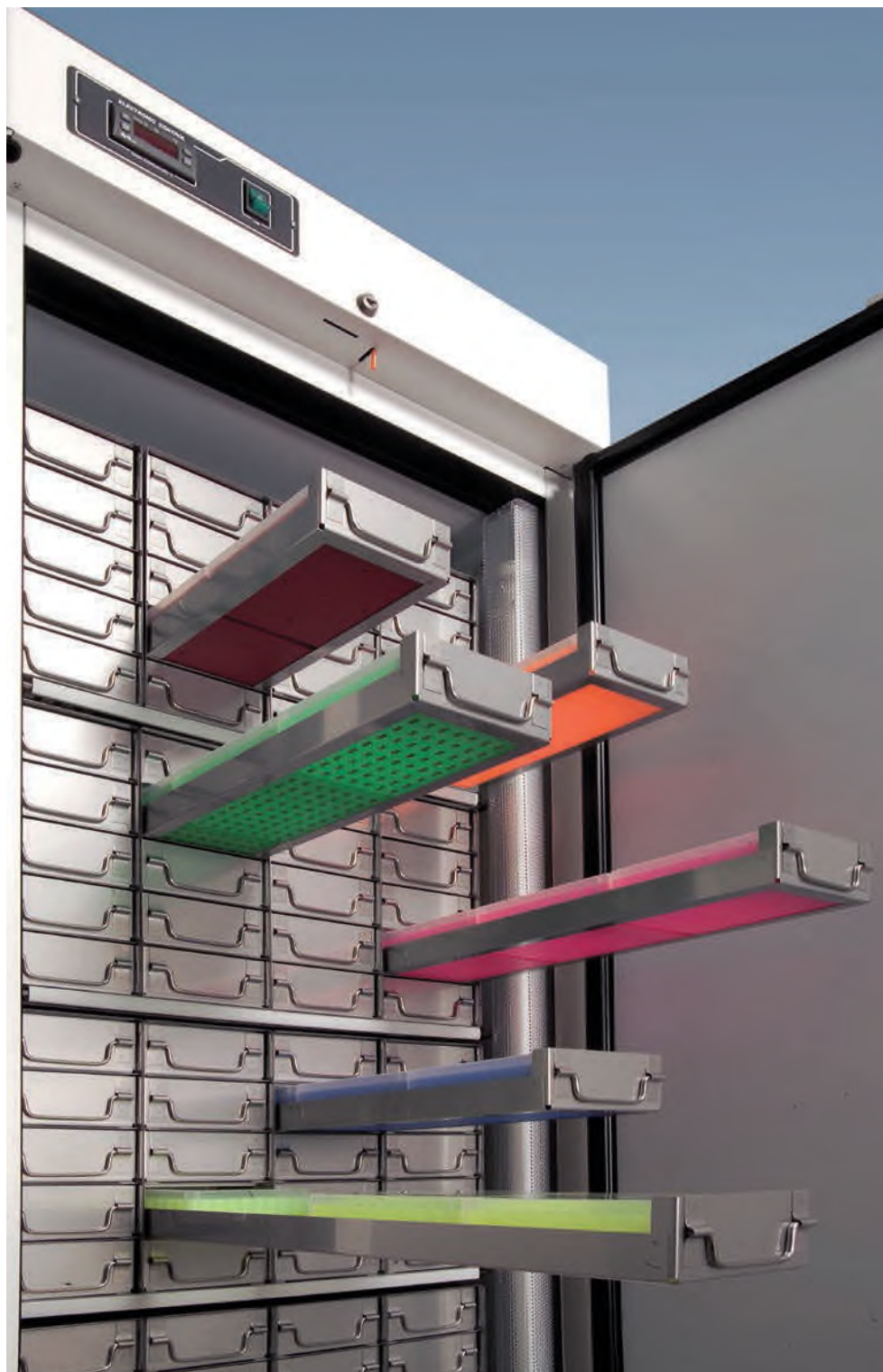



All rights and changes reserved · © 2015 Copyright by National Lab. Reg: LAB-KAT-EN-150615



National Lab GmbH
Refrigeration Technology
Grambeker Weg 157
D-23879 Moelln
Tel.: +49 45 42/84 91-70
Fax: +49 45 42/84 91-71
E-mail: LabSales@NationalLab.com
www.NationalLab.com

