

**TOMORROW
LAB** SINCE 1945

75
YEARS

eppendorf

HELAGO®



Catalog 2020/21

Liquid Handling, Sample Handling, Cell Handling



Scan on with the Eppendorf App!

Eppendorf now offers a fast-track option. You can now easily register your products with the Eppendorf App. It only takes three simple steps!

- > Download the free Eppendorf App
- > Scan the 2D code applied on your product
- > See your products on a single glance

For each registration you can receive up to 100 epPoints® and enjoy exclusive benefits in the future. And there is even more to explore in our Eppendorf App.

Get the app and start scanning!
www.eppendorf.com/scan-on



Note: If your Eppendorf product is not supplied with a 2D code you can still register your instrument manually by entering the serial number. Either use the app or use the typical method via the website: www.eppendorf.com/product-registration

Dear Readers,



We have a reason to celebrate!
This year marks Eppendorf's 75th anniversary!

The humanitarian vision of our company's founders is as present today as it was then: to improve people's living conditions. Our story began with a stimulation current device for medical diagnostics and therapy. Since then, numerous new devices and techniques have been developed that have significantly improved life sciences.

In the course of time, the medium-sized company has become a holistically thinking world market leader. Today, Eppendorf has 3,300 employees in 26 countries and is valued worldwide as expert and consultant.

We continually invest in innovating our products, services and business solutions, also by engaging with partners and customers in strong networks, focused on applications in the fields of sample, cell and liquid handling. The people who use our products every day in laboratories around the world are at the focus of our attention. With customized services and product solutions, we want to make your work easier and guarantee maximum accuracy of your results.

Quality, reliability, experience, innovation are words that you associate with Eppendorf. Our good reputation is based on our commitment to improve. In the future, digitalization will play an increasingly important role. The intelligent, digital networking of products will be of great importance. We are happy to accompany you into a new age.

We all are Eppendorf – shaping the ongoing success story together!

Your Eppendorf team



Eppendorf Online Shop

Further information on our product portfolio, service offerings and current sales promotions can be found on our website. Visit and order at

www.eppendorf.com/eshop

Eppendorf Magazines

Do you know both our magazines yet? BioNews and Off the Bench? Visit us on our website and register for a free subscription.

We look forward to hearing from you!

www.eppendorf.com/magazine



Eppendorf on Social Media

Do you already know our Eppendorf social media channels? Follow us to get stories beyond science, learn more about our products, and get tips & tricks for your daily work. Furthermore, stay up to date and do not miss any interesting webinars or events!

Keep up with what's new:

www.facebook.com/eppendorf

www.twitter.com/eppendorf_ag

www.linkedin.com/company/eppendorf-ag



Table of Contents



i

INTRODUCTION 6-17

- > New Highlights 2020 6-9
- > Handling Solutions knowledge hub 10
- > Digital Lab Solutions 11
- > Pure Quality 12-13
- > OEM/Customized Solutions 14-17



i

epServices 374-402

- > epServices, Application Support 374-375
- > Performance Plans Liquid Handling 376-383
- > Performance Plans Sample Handling 384-393
- > Performance Plans Cell Handling 394-401
- > Performance Plans Bioprocessing 402



i

LIQUID HANDLING 26-103

- > Pipettes 26-45, 80
- > Eppendorf Purity Grades for Tips 46-47
- > Pipette tips, Combitips, ViscoTip 48-69, 76-79
- > Dispensers 70-75
- > Pipette controller, pipette helper 80-81, 83
- > Serological pipettes 82
- > Bottle Top dispenser 84-87
- > Automated pipetting systems 88-103



i

EU-IVD AND EU-MD PRODUCTS 403-434

- > Liquid Handling 403-417
- > Sample Handling - tubes 418
- > Sample Handling - centrifuges 419-430
- > Cell Handling 431-434



i

SAMPLE HANDLING 104-289

- > Mixers and temperature control systems 104-119
- > Reaction tubes, plates, storage boxes and racks 120-141
- > Centrifuges and rotors 142-227
- > Concentrators 228-231
- > Photometry and Detection 232-245
- > PCR thermocyclers and consumables 246-265
- > Freezers 266-289



i

INDEX 435-483

- > Alphabetical Index 435-440
- > Index of order numbers 441-449
- > Different mains voltage versions 450-459
- > Your local contact 460-469
- > Legal notices, trademarks, patent and design attributions 470-483



i

CELL HANDLING 290-373

- > Micromanipulation 290-309
- > Cell Culture and Cell Imaging Consumables 310-321
- > CO₂ Incubators 322-333
- > Shakers 334-355
- > Bioprocessing 356-373



White Papers



Application Notes



Graphics



Augmented Reality



360° View



Brochures



Videos



Websites

Are you looking for more Details?

Do you miss further information or simply wish additional details?

On our catalog pages you will find QR codes with icons showing you what kind of materials (brochure, website, 360 degree views and much more) we offer for viewing or downloading.

Simply scan the QR Code on the corresponding pages and make use of our online offers.

New Highlights 2020



LIQUID HANDLING



Move It® - multichannel pipettes with adjustable tip spacing - see page 41

Often, single channel pipettes are used for multiple sample transfer from one vessel type to another, from tubes to plates for instance. This can be time-consuming and inconvenient, especially when throughput increases. Instead of pipetting many times, up to twelve samples can now be moved simultaneously with the new 4, 6, 8 and 12-channel pipettes Eppendorf Research® plus and Eppendorf Xplorer® plus Move It.

Move It pipettes have adjustable cones for variable tip spacings according to your vessel format. This easy handling of format changes helps to reduce throughput time by approximately 50% and increase the reproducibility of your results.

epT.I.P.S.® 384 and ep Dualfilter T.I.P.S.® 384 New pipette tips for 16- and 24-channel pipettes - see page 51 and 54

The new epT.I.P.S.® 384 and ep Dualfilter T.I.P.S.® 384 are optimized for the usage of 16- and 24-channel pipettes and available in volumes of 20 µL and 100 µL. For the first time, it is possible to evenly and simultaneously fill 24 wells of a 384-well plate in just one step enabling for equal starting conditions in each well of a row, thus increasing reproducibility to a maximum. The new system distinguishes itself by reduced attachment and ejection forces for fatigue free serial pipetting fulfilling the high demands of the Eppendorf PhysioCare Concept®. At the same time, it guarantees phenomenal reliability in terms of tip fit and tightness contributing to increased sample safety.

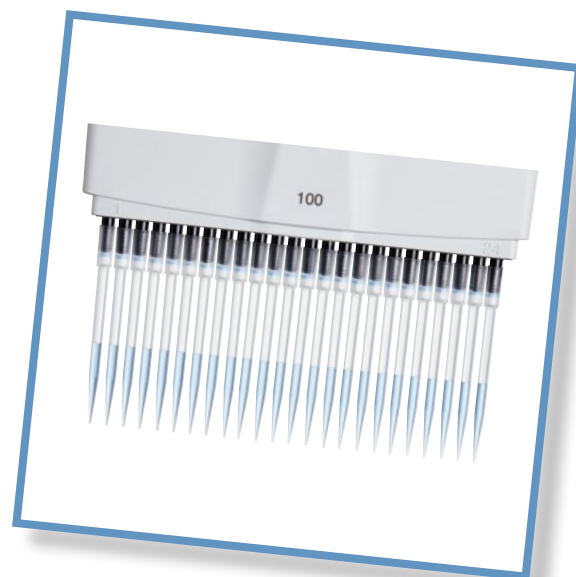

epMotion® 5073m NGS solution - see page 94

Step away from manual NGS library prep with an automated solution for up to 32 samples. Renowned Eppendorf precision and accuracy is guaranteed by the three single and multichannel pipetting tools in the volume range covering 1-300 µL. A special rack accommodates all required solutions. The optimized epBlue™ software enables smart tip usage and is easy to program. Pre-qualified Illumina methods enable you to start right away. And all of that on a footprint of only 6 letter-sized pieces of paper. Notification emails generated by the system to alert you about manual steps allow you to focus your attention on other tasks.

The solution for your reliable NGS library: epMotion® 5073m NGS solution



SAMPLE HANDLING

The Next Level - Eppendorf Conical Tubes 25 mL - see page 126

Very often sample volumes higher than 15 mL but much lower than 50 mL need to be prepared, centrifuged, mixed or stored. In awareness of this fact, Eppendorf has developed a new tube format - the Eppendorf Conical Tubes 25 mL. This new member of the big Eppendorf Tube Family fills the gap between the traditional conical tubes of 15 mL and 50 mL. This new format has the same diameter as the 50 mL conical tube but is not as long. Thus the insertion depth of pipettes into the tube is much lower compared to a 50 mL conical tube. The new 25 mL tube is available with screw cap and also with an innovative SnapTec™ cap. This patented lid solution represents a unique snap cap lid within the conical tubes segment.



Rotor FA-6x250 - see page 222

Until now, the use of the popular 250 mL bottles has been limited to swing-bucket rotors with a maximum speed of slightly more than 5,000 x g and a capacity of four bottles per run. The new fixed-angle rotor FA-6x250 allows simultaneous centrifugation of six 250 mL bottles at speeds exceeding 15,000 x g – thus considerably expanding the application spectrum of the large refrigerated benchtop systems by Eppendorf, Centrifuge 5910 R and Centrifuge 5920 R.

CryoCube® F101h Need your samples close at hand? - see page 272/278

The new CryoCube F101h is the Eppendorf green entry for the 100 L personal ULT freezer class. The freezer easily fits under your bench so your samples are always securely close-at-hand.

The green/ hydrocarbon-based cooling liquids are future-proof and fulfill sustainability requests. As being one of the very first movers for green cooling liquids at -86 °C, Eppendorf has now more than 10 years of experience in R&D, production, logistics, and service in the field.



New Highlights 2020



SAMPLE HANDLING

Eppendorf SafeCode™ system - see page 280

Safe sample identification needed? The more samples you handle in your lab, the more important it is to properly identify every sample. The Eppendorf SafeCode system is based on datamatrix coded pre-labeled CryoStorage Vials for longterm storage. The sample codes can directly be transferred into databases like Eppendorf eLABJournal® for documentation purposes.



Eppendorf CryoStorage Vials - see page 281

Barcoding your storage treasures?

The SafeCode system for Eppendorf CryoStorage Vials is based on a 3-level coding to enable safe sample identification. By providing 1D barcode combined with clear coding at the side and 2D datamatrix code with ECC 200 error correction at the bottom of the tube, a safe ID is set. Up to 96 pre-labeled vials are pre-racked and pre-capped for convenient usage. Different volume classes of vials enable efficient and safe sample storage at -80 °C.

Eppendorf RackScan - see page 283

Reading more than one sample in parallel? The Eppendorf RackScan offers various solutions for scanning sample tubes with Datamatrix (2D codes). The Eppendorf RackScan b scans data from the bottom of vessels. You can extend the bottom scanning by the RackScan s accessory for side scanning processes. Data can be exported in different formats to downstream software applications like Eppendorf eLABJournal or other data management systems.



CELL HANDLING

SciVario™ twin – see page 362

The SciVario™ twin system is a new compact state of the art bioprocess controller for parallel and individual operation of 2 bioreactors. It supports microbial and cell culture applications in both reusable glass vessels and single-use BioBLU® vessels.

The innovative bay/drawer concept allows easy upgrades with additional modules whenever needed to adapt to changing needs in the future. The intuitive VisioNize® on-board touchscreen user interface helps efficiently control and monitor various processes. With integrated support for digital sensors (Mettler Toledo® ISM and Hamilton® ARC), variable speed pumps for liquid additions and individual MFC control of gases for submerged and overlay gassing, this new controller provides the features needed for any application in the bioprocess R&D lab today and tomorrow.



EPENDORF DIGITAL

New design of the Eppendorf App

Do you already know our app?

The Eppendorf App with its new splendid design is based on the latest technology to provide better usability. Have more fun browsing through the product catalog to find the right product for you. Start with the many possibilities to get information about our products and to compare them. Thanks to the improved AR function, it is now even easier to place products virtually in your lab. Experience the diversity of Eppendorf on a 1:1 scale. Plan space requirements and configure accessories comfortably from your tablet or smartphone.

Here are some more highlights you will find in our app:

- > Register all your Eppendorf devices easily
- > Scan your epPoints quickly and easily
- > Calculate the amount of crude oil/polypropylene that has been saved through the innovative design of your new epT.I.P.S.® or ep Dualfilter T.I.P.S.® disposable racks.

Download the Eppendorf App! We wish you a lot of fun!

To use the latest functions of the app, your device needs the operating system IOS 13.0 or higher.

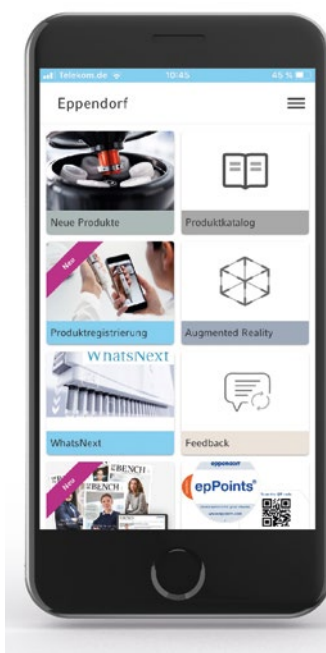

The Question "Why?"



The "why" is one of the key questions for every scientist. Beyond the standard working steps in the lab, there are aspects which are of interest. Aspects which are commonly not part of trainings and studies in universities, which are not described in an operating manual or product brochure, where the colleague fails to answer but which are important for real life in the lab.

All these kinds of questions are of interest for you because you are a scientist. Scientists are curious, we always want to know, always want to understand, always try to get the full picture. The "we did it like this for ever" style or that shrug "there is always that effect, get used to it" does not make us feel happy.

How to improve the situation?

We at Eppendorf believe in the power of science and share your enthusiasm for it. With decades of experience, Eppendorf products have a reputation for ensuring reliable and reproducible results. Countless working hours of engineers, chemists, molecular biologists, biotechnology experts, and other colleagues flow into the development of Eppendorf instruments and consumables – thus creating a large pool of invaluable knowledge and experience in the fields of Liquid Handling, Cell Handling, and Sample Handling. Find yourself describing typical challenges in your daily routine and learn how to improve your results by considering simple tips and tricks.

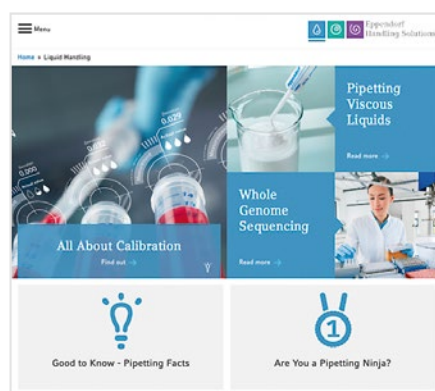

Liquid Handling

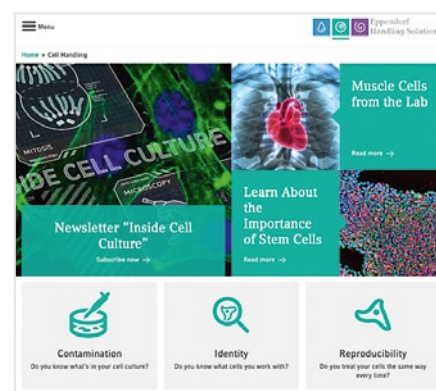

Cell Handling

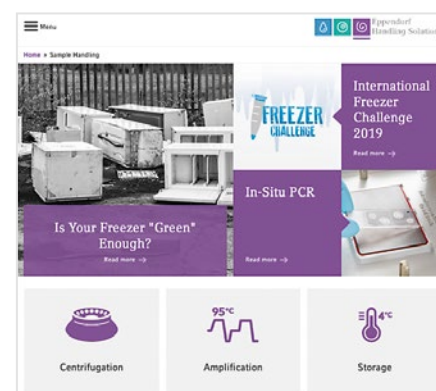

Sample Handling

We are happy to share this expertise at: www.eppendorf.com/handling-solutions

Visit our continuously growing Eppendorf Handling Solutions knowledge hub (content area) and discover answers about topics like storage, centrifugation, amplification, cell culture, liquid handling, photometry, and more.

Please feel free to contact us if you have further topics you want to read about.



Digital Lab Solutions @ Eppendorf



You and Your Lab. Connected.

VisioNize® is the **Eppendorf digital platform**, delivering valuable services in and around our Eppendorf devices – to continuously improve your lab life. Using our smart digital companion VisioNize, you can confidently guide your lab toward a smarter future.

All our **VisioNize-onboard devices** come equipped with the **VisioNize touch interface**, providing a convenient user experience as well as enabling smart features like recurring tasks directly on the device.

In addition, the **VisioNize services** offer you the possibility to remotely monitor your lab equipment and give you the opportunity to set customizable notifications to meet your and your lab's needs. **Leverage the built-in capabilities** of your Eppendorf lab instruments **by subscribing for our VisioNize cloud services.**

Learn more about the benefits of connectivity: www.eppendorf.com/visionize

You and Your Experiments. Organized.

Struggling with paper-based documentation? Documentation of working steps can be done in a digital manner. Every life science lab is now generating experimental **results in digital form**. Efficiently **manage your laboratory information** with software, customized to **meet your and your lab's needs.**

Learn more about **eLABJournal®** – the Electronic Lab Notebook to **document research and track** research data in a GLP compliant manner and the **eLABInventory** – to **efficiently track any sample** in the lab.

eLABJournal and eLABInventory are **suitable for any lab** ranging from small academic laboratories and start-up companies to large academic institutes and globally operating companies. **Designed by scientists for scientists.**

Learn more about Eppendorf laboratory information management solutions: www.eppendorf.com/elab



Pure Quality

Eppendorf purity grades for consumables

- > Eppendorf consumables stand for the high quality and purity achieved by:
- > using pure raw materials
- > automatic production in clean room conditions
- > quality and functional checks of all lots
- > continuous quality assurance throughout the entire production process

With the strict control criteria, internally and externally monitored, we guarantee consistently high quality of our products – lot by lot. Our consumables are available in different purity grades for individual application demands: “Eppendorf Quality™” as well as advanced purity grades like “sterile”, “protein-free¹⁾”, “PCR clean”, “Forensic DNA Grade (acc. to ISO 18385)”, and “Biopur®”.



The Eppendorf purity grade “Eppendorf Quality” fulfill everything expected of reliable, easy-to-handle consumables. With the aid of high-quality base material and permanent checks during production, Eppendorf consumables in Eppendorf Quality are ideal for many tasks in the lab.

Eppendorf Quality™:

Products with the purity grade “Eppendorf Quality” are ideal for many tasks in the lab. To meet consistently our customer’s high demands on quality further measurements are performed specifically for individual product groups:

Precise molding ensures high precision and accuracy. Each lot of tips is subject to gravimetric measurement during final testing. Low wetting ensures reliable volume readings and minimal adhesion.

- > Eppendorf Tubes® have to be opened and closed by one hand only; without sample material being contaminated. They are highly stable, even when exposed to extreme mechanical or thermal strain. Therefore, on a daily basis we check vapor tightness, lid-opening force, wall strength, force required to pierce the lid as well as resistance to centrifugation.
- > We check high resistance to centrifugation and sealability of deepwell plates and microplates.
- > All production tools are subject to frequent checks at regular intervals in order to guarantee consistent quality throughout the entire production period.

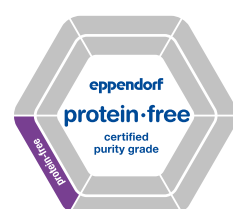

Eppendorf consumables with this purity grade are free of proteins and thus free of unspecific signals or reactions due to protein contamination.

Eppendorf Protein-free:

A colorimetric assay which can detect down to 1ng/μL is used for testing and detecting protein contamination. Lot-specific certificates provided by an external accredited laboratory are available on request and on our website. Furthermore, all Eppendorf protein-free products fulfill the quality standards defined for our purity grade “Eppendorf Quality”.

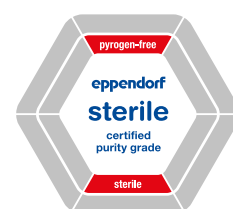

Eppendorf consumables with the purity grade “Sterile” are sterilized in accordance with ISO 11137 or ISO 11135 with a Sterility Assurance Level (SAL) of 10⁻⁶. Lot-specific certificates document sterility and the absence of¹⁾ endotoxins in accordance with Ph. Eur. 2.6.14.

Eppendorf Sterile:

Besides fulfilling the quality criteria of “Eppendorf Quality” Eppendorf consumables with the purity grade “sterile” are sterilized and free of pyrogens. Each lot is certified by an external accredited laboratory. Eppendorf sterile consumables are sterilized in accordance with ISO 11137 or ISO 11135. A quality seal which assures customers of the suitability of their Eppendorf consumables for direct use in experiments and analysis without the need for further treatment. Lot-specific certificates are available on request and on our website.

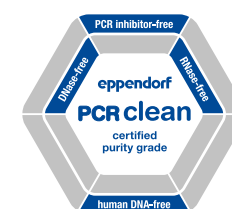

All Eppendorf consumables with the purity grade “PCR clean” are DNase- and RNase-free, and free of PCR-inhibitors. It is also guaranteed that the consumables are free of contaminating human DNA.

Eppendorf PCR clean:

All Eppendorf consumables with the purity grade “PCR clean” ensure not to interfere with the PCR. Furthermore, all Eppendorf PCR clean products fulfill the quality criteria defined for our standard consumables (purity grade “Eppendorf Quality”). The purity grade “PCR clean” is essentially achieved in not even letting contamination develop. Therefore, the corresponding plastic items are manufactured comparable to clean-room conditions. The manufacturing areas are spatially separated and only personnel in special protective clothing are granted access. Lot-specific certificates provided by an external accredited laboratory confirm the compliance with the criteria DNase-, RNase-, PCR inhibitor-, and human DNA-free. The certificates are available on request and on our website. “PCR clean” – a quality seal which assures customers of the suitability of their Eppendorf consumables for direct use in experiments and analysis.

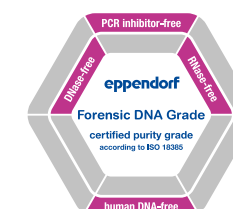

The demanding requirements of the ISO 18385 are fulfilled by “Eppendorf Forensic DNA Grade” consumables. These products help to further minimize the risk of human DNA contamination in forensic DNA analysis. Individually blistered packaging or “mini batches” in re-sealable bags also help to protect against contamination.

Eppendorf Forensic DNA Grade (acc. to ISO 18385):

Human DNA contamination is one of the main concerns in forensic DNA analysis. The ISO 18385 has been implemented to further minimize the risk of DNA contamination. This standard specifies requirements for manufacturing products used in the collection, storage and analysis of biological material for forensic purposes. Highly automated production lines and stringent access controls are only two production conditions for “Eppendorf Forensic DNA Grade” consumables which contribute in fulfilling ISO 18385. Individually blistered packaging or “mini batches” in re-sealable bags provide effective protection against contamination. Lot-specific certificates provided by an external accredited laboratory confirm the compliance with the criteria DNase-, RNase-, PCR inhibitor-, and human DNA-free. The certificates are available on request and on our website.

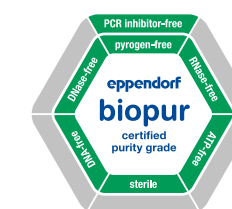

Consumables available in this highest possible degree of Eppendorf purity grades are guaranteed to be sterile and free of pyrogens, RNases, DNases, DNA and ATP as well as PCR inhibitors. Individually blistered or “mini batches” in re-sealable boxes provide effective protection against soiling and contamination.

Biopur®:

To meet the highest demands of the clinical, pharmaceutical, cosmetic, food industries and others, Eppendorf defined the quality and purity grade “Biopur”. This purity is ensured by an elaborate, automated manufacturing process which safeguards the product against contamination with biological substances. Furthermore, all “Biopur” products fulfill the quality standards defined for our standard consumables (Purity grade “Eppendorf Quality”). Lot-specific certificates provided by an external accredited laboratory confirm the compliance with the criteria sterile, DNase-, RNase-, PCR inhibitor, ATP-, Pyrogen-, human and bacterial DNA-free. The certificates are available on request and on our website. “Biopur” – a quality seal which assures customers of the suitability of their Eppendorf consumables for direct use in experiments and analysis.

In addition to our internal process controls, and general quality certificates, lot-specific certificates are provided by an external test laboratory for the advanced purity grades. This allows us to consistently meet our customers' high demands when it comes to the high quality and purity of our products. As a special service, our lot-specific certificates are available on request and on our website (www.eppendorf.com/certificates)

The basis: Top-quality material

- > All plastics used by Eppendorf to produce consumables comply with international purity criteria.
- > The dyes used to color consumables are free of¹⁾ organic substances and substances containing heavy metals.
- > Plastics, such as polypropylene, have a high chemical resistance to organic and inorganic acids/ bases and organic solvents commonly used in laboratories.

¹⁾ The suffix/wording “-free” respectively “absence/free of” in the context of purity grades means that the test showed conformity within the detection limits.

OEM

Sample Integrity is Paramount



Once lost or compromised, a sample is gone forever. Often additional samples cannot be retrieved or only with substantial costs or time delays. Thus, sample integrity is paramount. It must be established and maintained throughout the workflow. Making compromises, even in a single workflow step, can jeopardize your sample and the entire result.

Sample integrity is dependent on three main elements:

- > Avoiding contamination
- > Minimizing unspecific binding of rare or selected molecules
- > Reproducibility of processes

1. Avoiding contamination

There is a vast diversity of unwanted contaminants:

- > Target molecules, leading to false-positive results
- > Molecules with comparable characteristics in e.g. photometry, leading to false-positive results.
- > Reaction inhibitors, leading to false-negative results
- > Chemicals degrading the target molecules or cells, leading to false-negative results
- > Leaching substances from certain consumables

General Good Laboratory Practice is fundamental to prevent contamination. Additionally, the right products can help in this endeavor. Tight fitting tube caps, raised rims of plate wells, individually wrapped consumables, aerosol-tight centrifuge rotors, powerful UV lamps, etc. all help to avoid contamination.

Learn more about leachables
www.eppendorf.com/leachables-notes/



www.eppendorf.com/sample-integrity

2. Minimizing unspecific binding of rare or selected molecules

Some samples are in low abundance from the beginning. Especially in these cases, it is crucial to retain as much as possible of your target molecule or cells throughout your workflow. Eppendorf consumables with low binding characteristics can reduce target molecule loss substantially.

Learn more about low binding consumables



www.eppendorf.com/dna-lobind-tubes

3. Reproducibility of processes

Maintaining sample integrity continuously throughout the process from raw material to reportable result is a daily challenge in every lab. Eppendorf products with their verified performance specifications support consistent processes and reproducible test results in every single run.



Are 4 °C in a centrifuge really 4 °C?

Eppendorf has data on product performance to help maintain reproducibility of your processes across different centrifuges, users or runs.



Were the 5 µL you pipetted really 5 µL?

Precision and accuracy of pipetting tools are crucial for any workflow. Eppendorf has the right tools, no matter what viscosity, density, temperature etc. your liquids have.



Do you get an unbiased selection of target molecules?

Smart consumables with LoBind characteristics avoid binding to vessels or pipette tips and help to get optimized results!

Request your OEM solution

Do you want to know more about how we can support you with OEM solutions?
 Please contact us at oem@eppendorf.com



www.eppendorf.com/oem

OEM

Your Global Supplier for OEM Solutions

Eppendorf is well known for its high quality standard, innovative technology and cutting-edge developments. Take advantage of our competence and decades of experience in developing and manufacturing high-tech laboratory products. With our R&D know-how in many fields of laboratory instrumentation and consumables, we can offer you support in the design of your OEM product across the board. All our products are manufactured to the highest quality standards as we have our own production facilities.



Manufacturing Eppendorf consumables for your needs

- > Fully automated manufacturing facilities ensure lowest level of contamination
- > Injection molds are crucial for achieving outstanding product quality - Eppendorf is the only tip manufacturer that develops and manufactures its own molds, resulting in very high product specifications and very low failure rates during production
- > Production scalability up to very high volumes can be achieved by use of molding systems with 32 up to 128 cavities
- > Automated quality checks measure coaxiality and residual volume of tips as well as 100% in-line filter inspection
- > Manufacturing sites in Germany and the US secure delivery on-time worldwide

Customized consumables

Eppendorf offers a broad range of consumables including a broad diversity of plates: PCR, MTP, DWP and cell culture. Whether you choose one of our standard products with a specific packaging or you prefer a customization, for example, a specific surface treatment, please contact us. We will support you with an optimized solution.

Watch video about customized OEM consumables.



www.eppendorf.com/oem-video

Customized tips for automation

Countless liquid handling workstations in the world work with Eppendorf conductive or non-conductive tips, benefitting from our high quality standards. Eppendorf tips for automation can cover a broad range of tasks in all major life science applications. Upon request, Eppendorf tips can also be equipped to comply with specific requirements.



The customized Eppendorf automation tips can be found offering solutions to requirements, such as:

- > Conductive or non-conductive
- > With or without sophisticated filter
- > Special tray colors
- > Different volumes and dimensions
- > Customized materials
- > Customized packaging and labeling

Customized automated pipetting workstations

A broad range of Eppendorf instruments, such as the automated liquid handling workstation *epMotion*®, is available for OEM.

From logo or color adaptations all the way to specific software and hardware functions - just let us know what you need!

Request your OEM solution

Do you want to know more about how we can support you with OEM solutions? Please contact us at oem@eppendorf.com



<https://www.eppendorf.com/oem>



Liquid Handling



Model	Eppendorf Research® plus	Eppendorf Reference® 2	Eppendorf Xplorer®/ Eppendorf Xplorer® plus
Page(s)	26	32	35
Product type	Pipette	Pipette	Pipette
Operating mode	Manual	Manual	Electronic
Adjustable cone spacing	no	no	no
Pipetting type	Air-cushion	Air-cushion	Air-cushion
Positioning	Ultra light weight and pipetting forces for advanced ergonomics	Reliability in robustness and results	Efficient and more precise pipetting
Application	Pipetting of aqueous liquids, two-button operation	Pipetting of aqueous liquids, single-button operation	Pipetting of aqueous liquids
Volume range	0.1 µL – 10 mL	0.1 µL – 10 mL	0.5 µL – 10 mL
Available options	1-channel 8-channel 12-channel 16-channel 24-channel	1-channel 8-channel 12-channel	1-channel 8-channel 12-channel 16-channel 24-channel
RFID tracking	Yes	Yes	Yes
Autoclavable	Yes	Yes	Yes (lower part)
Consumables	universal tips, epT.I.P.S.®	universal tips, epT.I.P.S.®	universal tips, epT.I.P.S.®, epT.I.P.S.® 384
Purity grades of consumables	> Eppendorf Quality™ > PCR clean and sterile > Biopur® > Forensic DNA Grade	> Eppendorf Quality™ > PCR clean and sterile > Biopur® > Forensic DNA Grade	> Eppendorf Quality™ > PCR clean and sterile > Biopur® > Forensic DNA Grade



Model	epT.I.P.S.®	epT.I.P.S.® Long	ep Dualfilter T.I.P.S.®	ep Dualfilter T.I.P.S.® SealMax
Page(s)	48	52	53	55
Applications	<ul style="list-style-type: none"> > Pipetting liquids > Dispensing liquids > Mixing liquids > Filling plates and reaction vessels > For applications in 384-microplate format we recommend using 16 or 24-channel pipettes together with epT.I.P.S.® 384 			
	<ul style="list-style-type: none"> > DNA applications (e.g. PCR) > RNA applications (e.g. gene expression analysis) > Protein applications (e.g. antibody research) > Cell culture applications (e.g. media) > Applications with radio actives > All applications which use aerosol¹⁾ binding liquids > For applications in 384-microplate format we recommend using 16 or 24-channel pipettes together with ep Dualfilter T.I.P.S.® 384 			

¹⁾ An aerosol is a colloid of fine solid particles or liquid droplets, in air or another gas.



Model	Eppendorf Research® plus Move It®/ Eppendorf Xplorer® plus Move It®	Varipette®	Multipette® M4	Multipette® E3/E3x
Page(s)	41/41	80	70	73
Product type	Pipette	Pipette	Dispenser	Dispenser
Operating mode	Manual/Electronic	Manual	Manual	Electronic
Adjustable cone spacing	yes	no	no	no
Pipetting type	Air-cushion	Positive displacement	Positive displacement	Positive displacement
Positioning	Double your pipetting performance: fast and secure multiple sample transfer between different formats made easy	Fault tolerant pipetting of large volumes, independent of external effects	Time saving by acceleration of long pipetting series with low outside fault effects	Time saving by acceleration of long pipetting series, with highest volume flexibility and lowest outside fault effects
Application	Pipetting of aqueous liquids	Contamination-free pipetting of aqueous, viscous and volatile liquids	Contamination-free dispensing (up to 100 steps per Combitips Tip filling) of aqueous solutions, and problem liquids (e.g., viscous, volatile, dense...)	Contamination-free dispensing (up to 100 steps per Combitips Tip filling) of aqueous solutions, and problem liquids (e.g., viscous, volatile, dense...)
Volume range	1 – 1,200 µL	1 – 10 mL	1 µL – 10 mL	1 µL – 50 mL
Available options	4-channel 6-channel 8-channel 12-channel	1-channel	1-channel	1-channel
RFID tracking	Yes/Yes	No	Yes	Yes
Autoclavable	Yes/Yes (lower part)	No	No	No
Consumables	universal tips, epT.I.P.S.®, epT.I.P.S.® 384	Varitips	Combitips advanced®	Combitips advanced®
Purity grades of consumables	> Eppendorf Quality™ > PCR clean and sterile > Biopur® > Forensic DNA Grade	> Eppendorf Quality™	> Eppendorf Quality™ > PCR clean > Biopur® > Forensic DNA Grade	> Eppendorf Quality™ > PCR clean > Biopur® > Forensic DNA Grade



Model	epT.I.P.S.® LoRetention	ep Dualfilter T.I.P.S.® LoRetention	GELoader®	Microloader™
Page(s)	56	56	50	50
Applications	<ul style="list-style-type: none"> > Cell culture (media) > Genomics: PCR, RT-PCR, qPCR and all other types of PCR > Enzymatic reactions (restriction decomposition, ligation) > Isolation and purification of nucleic acid > Gel electrophoresis (e.g., prefabricated DNA ladders) typical detergents: SDS, Triton®, X-100, Brij® 35, Tween® 20, CHAPS > Proteomics (all types of protein examinations) > Protein isolation and purification > NGS library preparation 			
	<ul style="list-style-type: none"> > Gel electrophoresis > Loading of samples onto polyacrylamide gels > Handling of smallest volumes 			
	<ul style="list-style-type: none"> > Pipette tip for back-filling of Femtotips and other microcapillaries 			



Liquid Handling



Model	Varispenser® 2 / Varispenser® 2x	Eppendorf Top Buret™
Page(s)	84	86
Product type	Bottle-top dispenser	Bottle-top burette
Operating mode	Manual	Manual
Pipetting type	Positive displacement	Positive displacement
Positioning	Varispenser 2 and 2x bottle-top dispensers combine trusted technology with improved benefits for safe and easy dispensing of liquids without compromise	Continuously and pulse-free manual titration
Application	Single stroke dispensing of lyes, acids, bases, aqueous liquids or solvents	Titration of aqueous liquids
Volume range	0.2 – 100 mL	0.1 – 999.9 mL
Available options	1-channel	1-channel
RFID tracking	No	No
Autoclavable	Yes	No
Consumables	–	–
Purity grades of consumables	–	–



Easypet® 3	Pipet Helper®	epMotion® 96/epMotion® 96xl with 2-position slider
81	82	88
Pipette controller	Pipette controller	Semi-automated Pipette
Electronic	Manual	Electronic
Air-cushion	Air-cushion	Air-cushion
Overall ergonomic concept with new speed control for stress-free pipetting	The robust and intuitive design makes it a perfect entry-level instrument	Intuitive and fast pipetting in 96 and 384 format
Pipetting of aqueous liquids with serological and volumetric pipettes	Pipetting of aqueous liquids with serological and volumetric pipettes	Pipetting of aqueous liquids
0.1 – 100 mL	0.1 – 100 mL	0.5 – 300 µL/5 – 1,000 µL
1-channel	1-channel	96-channel
Yes	No	No
Yes (pipette adapter and aspirating cone)	Yes	No
serological pipettes	serological pipettes	epT.I.P.S.® motion reload system
> Sterile, pyrogen-, DNase-, RNase-, human and bacterial DNA-free. Non-cytotoxic.	> Sterile, pyrogen-, DNase-, RNase-, human and bacterial DNA-free. Non-cytotoxic.	> Eppendorf Quality™ > PCR clean > PCR clean and sterile



Model	Combitips advanced®
Page(s)	77
Applications	<ul style="list-style-type: none"> > Positive displacement principle (comparable to a syringe) > High-precision dispensing regardless of the physical properties of the liquid (e.g., viscosity, volatility, density, temperature...) > Prevents aerosol contamination with hermetically sealed piston for secure dispensing > Provides protection from radioactive and toxic substances > Quick dispensing of long series with precise, repeated dispensing of identical volumes (with Multipette hand dispensers)

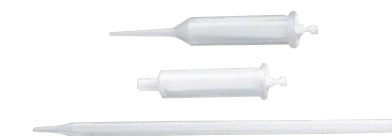

ViscoTip®	Eppendorf Varitips®
76	80
<ul style="list-style-type: none"> > Positive displacement principle (comparable to a syringe) > For highly viscous liquids > Quick dispensing of long series with precise, repeated dispensing of identical volumes (with Multipette hand dispensers) 	<ul style="list-style-type: none"> > Pipetting aqueous solutions > Extraction of liquids from deep receptacles > Transfer of organic liquids (alcohols, org. acids etc.) > Transfer of solvents with high vapor pressure (e.g. diethyl ether) > Transfer of liquids with high density > Transfer of viscous liquids

Liquid Handling



Model	epMotion® 5070	epMotion® 5070f
Page(s)	89	89
Dimensions (W x D x H)	65 x 48 x 63 cm / 26 x 19 x 25 in	65 x 48 x 63 cm / 26 x 19 x 25 in
Weight w/o accessories	45 kg	33 kg
Max. power consumption	150 W	150 W
Power supply	100 – 240 V ±10 %, 50 – 60 Hz ±5 %	100 – 240 V ±10 %, 50 – 60 Hz ±5 %
Optical confocal infrared detector	Contact-free recognition of fill level, inserted tools, labware, tip types and quantities	Contact-free recognition of fill level, inserted tools, labware, tip types and quantities
SLAS/ANSI positions	4	4
Volume range	0.2 µL – 1 mL	0.2 µL – 1 mL
Random measurement error	±0.1 mm	±0.1 mm
Systematic measurement error	±0.3 mm	±0.3 mm
Dispensing tool ¹⁾²⁾		
Random measurement error (1 µL)	≤3 %	≤3 %
Systematic measurement error (1 µL)	±5 %	±5 %
Random measurement error (50 µL)	≤0.4 %	≤0.4 %
Systematic measurement error (50 µL)	±1.2 %	±1.2 %
Random measurement error (1,000 µL)	≤0.15 %	≤0.15 %
Systematic measurement error (1,000 µL)	±0.7 %	±0.7 %
Pipetting type	Air-cushion	Air-cushion
Gripper option	no	no
Thermal module (optional)	no	no
Cooling rate	–	–
Heating rate	–	–
ThermoMixer upgrade option	no	no
Eppendorf ThermoMixer®		
Max. load	–	–
Mixing period	–	–
Speed	–	–
Temperature range	–	–
Magnetic separation	no	no
Vacuum separation	no	no
Automatic tool exchange	2 tools	2 tools
UV/HEPA option	no	no
For operation in biosafety cabinet	–	yes

¹⁾ in pipetting mode, free jet, without pre-wetting, with distilled water, at 20 °C ²⁾ See Eppendorf Application Note 168 for typical pipetting performance



New

Model	epMotion® 5073l	epMotion® 5073m NGS solution
Page(s)	90	94
Dimensions (W x D x H)	65 x 61 x 67 cm / 26 x 24 x 27 in	65 x 61 x 67 cm / 26 x 24 x 27 in
Weight w/o accessories	50 kg	57 kg
Max. power consumption	600 W	600 W
Power supply	100 – 240 V ±10 %, 50 – 60 Hz ±5 %	100 – 240 V ±10 %, 50 – 60 Hz ±5 %
Optical confocal infrared detector	Contact-free recognition of fill level, inserted tools, labware, tip types and quantities	Contact-free recognition of fill level, inserted tools, labware, tip types and quantities
SLAS/ANSI positions	6	6
Volume range	0.2 µL – 1 mL	0.2 µL – 1 mL
Random measurement error	±0.1 mm	±0.1 mm
Systematic measurement error	±0.3 mm	±0.3 mm
Dispensing tool ¹⁾²⁾		
Random measurement error (1 µL)	≤3 %	≤3 %
Systematic measurement error (1 µL)	±5 %	±5 %
Random measurement error (50 µL)	≤0.4 %	≤0.4 %
Systematic measurement error (50 µL)	±1.2 %	±1.2 %
Random measurement error (1,000 µL)	≤0.15 %	≤0.15 %
Systematic measurement error (1,000 µL)	±0.7 %	±0.7 %
Pipetting type	Air-cushion	Air-cushion
Gripper option	yes	yes
Thermal module (optional)	1	no
Cooling rate	4 °C/min	–
Heating rate	9 °C/min	–
ThermoMixer upgrade option	no	included
Eppendorf ThermoMixer®		
Max. load	–	1,000 g (2.2 lb)
Mixing period	–	5 s – 120 min
Speed	–	300 rpm – 2,000 rpm
Temperature range	–	15 °C below RT to 95 °C
Magnetic separation	with third party adapter and gripper	yes
Vacuum separation	no	no
Automatic tool exchange	2 tools and gripper	3 tools and gripper
UV/HEPA option	yes	yes
For operation in biosafety cabinet	–	–

epServices
for premium performance

On page 380 you will find detailed information on services for these products!



Technical specifications subject to change.

Your local distributor: www.eppendorf.com/contact
Eppendorf AG · Barkhausenweg 1 · 22339 Hamburg · Germany · eppendorf@eppendorf.com · www.eppendorf.com · www.eppendorf.com/eshop

Liquid Handling



Model	epMotion® 5075I	epMotion® 5075v
Page(s)	91	93
Dimensions (W x D x H)	107 x 61 x 67 cm / 43 x 24 x 27 in	107 x 61 x 67 cm / 43 x 24 x 27 in
Weight w/o accessories	85 kg	86 kg
Max. power consumption	700 W	700 W
Power supply	100 – 240 V ±10 %, 50 – 60 Hz ±5 %	100 – 240 V ±10 %, 50 – 60 Hz ±5 %
Optical confocal infrared detector	Contact-free recognition of fill level, inserted tools, labware, tip types and quantities	Contact-free recognition of fill level, inserted tools, labware, tip types and quantities
SLAS/ANSI positions	15	12
Volume range	0.2 µL – 1 mL	0.2 µL – 1 mL
Random measurement error	±0.1 mm	±0.1 mm
Systematic measurement error	±0.3 mm	±0.3 mm
Dispensing tool ¹⁾²⁾		
Random measurement error (1 µL)	≤3 %	≤3 %
Systematic measurement error (1 µL)	±5 %	±5 %
Random measurement error (50 µL)	≤0.4 %	≤0.4 %
Systematic measurement error (50 µL)	±1.2 %	±1.2 %
Random measurement error (1,000 µL)	≤0.15 %	≤0.15 %
Systematic measurement error (1,000 µL)	±0.7 %	±0.7 %
Pipetting type	Air-cushion	Air-cushion
Gripper option	yes	included
Thermal module (optional)	3	3
ThermoMixer upgrade option	yes	yes
Vacuum unit		
Vacuum max. output	–	35 NL/min
Magnetic separation	with third party adapter and gripper	with third party adapter and gripper
Vacuum separation	no	yes
Automatic tool exchange	4 tools and gripper	4 tools and gripper
UV/HEPA option	yes	yes

¹⁾ in pipetting mode, free jet, without pre-wetting, with distilled water, at 20 °C ²⁾ See Eppendorf Application Note 168 for typical pipetting performance



Model	epMotion® 5075t	epMotion® 5075m
Page(s)	92	92
Dimensions (W x D x H)	107 x 61 x 67 cm / 43 x 24 x 27 in	107 x 61 x 67 cm / 43 x 24 x 27 in
Weight w/o accessories	87 kg	88 kg
Max. power consumption	700 W	700 W
Power supply	100 – 240 V ±10 %, 50 – 60 Hz ±5 %	100 – 240 V ±10 %, 50 – 60 Hz ±5 %
Optical confocal infrared detector	Contact-free recognition of fill level, inserted tools, labware, tip types and quantities	Contact-free recognition of fill level, inserted tools, labware, tip types and quantities
SLAS/ANSI positions	14,5	14,5
Volume range	0.2 µL – 1 mL	0.2 µL – 1 mL
Random measurement error	±0.1 mm	±0.1 mm
Systematic measurement error	±0.3 mm	±0.3 mm
Dispensing tool ¹⁾²⁾		
Random measurement error (1 µL)	≤3 %	≤3 %
Systematic measurement error (1 µL)	±5 %	±5 %
Random measurement error (50 µL)	≤0.4 %	≤0.4 %
Systematic measurement error (50 µL)	±1.2 %	±1.2 %
Random measurement error (1,000 µL)	≤0.15 %	≤0.15 %
Systematic measurement error (1,000 µL)	±0.7 %	±0.7 %
Pipetting type	Air-cushion	Air-cushion
Gripper option	yes	yes
Thermal module (optional)	2	2
ThermoMixer upgrade option	included	included
Vacuum unit		
Vacuum max. output	–	–
Magnetic separation	with third party adapter and gripper	yes
Vacuum separation	no	no
Automatic tool exchange	4 tools and gripper	4 tools and gripper
UV/HEPA option	yes	yes

Only for epMotion 5073m, 5073mc and 5075m: Limited Use Label License

Notice to purchaser; limited license for research use only

This product and its use may be covered by one or more patents owned by Gen-Probe Incorporated. The purchase price for this product includes only limited, nontransferable rights under certain claims of certain patents owned by Gen-Probe Incorporated to use this product for research purposes only. No other rights are conveyed. Purchaser is not granted any rights under patents of Gen-Probe Incorporated to use this product for any commercial use. Further information regarding purchasing a license under patents of Gen-Probe Incorporated to use this product for any other purposes, including, without limitation, for commercial use, may be obtained by contacting Gen-Probe Incorporated, Attn: Business Development Department, 10210 Genetic Center Drive, San Diego, California 92121-4362, U.S.A.



Technical specifications subject to change.



On page 380 you will find detailed information on services for these products!

Your local distributor: www.eppendorf.com/contact

Eppendorf AG · Barkhausenweg 1 · 22339 Hamburg · Germany · eppendorf@eppendorf.com · www.eppendorf.com · www.eppendorf.com/eshop

Eppendorf Research[®] plus

The ultra light pipette that delights your hand

The Eppendorf Research plus mechanical pipette combines over 50 years of innovation in liquid handling and is one of the most commonly used pipettes in the world. It provides you with one of the safest and most ergonomic pipettes available today. The Research plus microliter pipette protects the health of our customers during their daily work in the laboratory. It has pioneered the renowned Eppendorf PhysioCare Concept[®] and thus reduced the strain on hand and arm during pipetting essentially. The Research plus is the pipette family with the lowest weight and lowest operation forces in the Eppendorf product families. Lower operation forces can only be reached with our Eppendorf electronic pipettes. Enjoy excellent flexibility and choose among single-channel pipettes in fixed or variable volume as well as multi-channel pipette options with 8, 12, 16 and 24 channels.



Product features

- > Air-cushion pipette for accurate pipetting of aqueous solutions
- > Feel the difference in weight and pipetting forces: the ultra light mechanical pipette is designed according to the strict criteria of the Eppendorf PhysioCare Concept and limits the strain on your hand and arm
- > Spring loaded tip cone (available for all pipettes up to 1 mL) for minimal tip attachment forces helps to reduce stress
- > Low tip ejection force of Eppendorf Research plus (3.6 N)
- > Adjust your pipette in seconds for better accuracy when pipetting various difficult liquids like ethanol or even when pipetting at high altitudes. Return to factory adjustment without calibration
- > Autoclave the entire pipette or only the lower part according to your needs to ensure decontamination
- > Enjoy excellent flexibility and choose among single-channel pipettes in fixed or variable volume as well as 8, 12, 16 and 24 channel pipettes

Applications

- > Forward pipetting
- > Reverse pipetting
- > Removal of supernatants
- > Sample mixing
- > Phase extraction
- > Filling of plates, gels, and reaction vessels

Forward and reverse pipetting

Transfer	Forward pipetting	Reverse pipetting
Liquid uptake	1. Press operating button down to 1st stop 2. Let operating button move up completely	1. Press operating button down to 2nd stop 2. Let operating button move up completely
Liquid discharge	3. Press operating button via 1st stop down to 2nd stop	3. Press operating button down to 1st stop
Observation	4. No liquid is left in tip after action	4. Liquid is left in tip after action (volume of blow-out)



> For more information go to: <https://handling-solutions.eppendorf.com/liquid-handling/pipetting-facts/pipetting-of-challenging-liquids/>



A joy for your eyes - The display

4-digit volume display with magnifying window. Easy to read. Allows for more accurate volume setting.

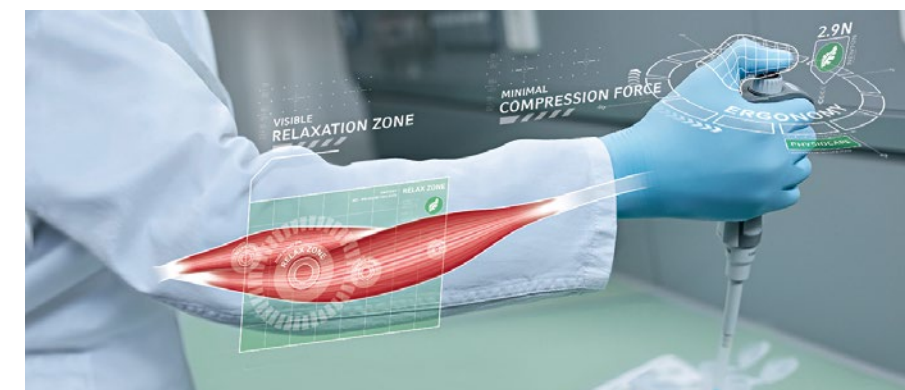

Fatigue-free pipetting

Strain on your hand and arm is limited by reduced tip attachment and ejection force. For more information go to <https://handling-solutions.eppendorf.com/liquid-handling/pipetting-facts/ergonomics/>

Secondary adjustment option for various liquid classes

Adjust your pipetting volume in seconds by up to $\pm 2\%$ for better accuracy when pipetting various difficult liquids like warm, cold, volatile or high density liquids or even when external conditions change (e.g., altitude or use of elongated tips). Change back to factory adjustment easily without calibration.



It is Your Choice

Eppendorf Research plus adjustable and fixed volume pipettes

Dispensing adjustable volumes within a range of 0.1 μ L and 10 mL is possible by using variable volume pipettes. Fixed volume pipettes are the perfect tool for beginners and labs on a budget. In addition, they allow working at a faster pace. Finally, it is less likely to commit an error and calibration is much more easier.

Eppendorf Research plus single- and multichannel pipettes

Depending on the vessel type you can choose between:

- > Single-channel pipettes for tubes
- > 8 and 12-channel pipettes for 96 and 24-well plates
- > 16 and 24-channel pipettes for 384-well plates

Eppendorf Research plus Move It pipettes with adjustable cone distance

When moving samples from one vessel format to another, instead of pipetting many times, up to twelve samples can now be moved simultaneously. Move It pipettes have adjustable cones for variable tip spacings according to your vessel format. See also page 41 for more information.

Eppendorf Research® plus

Single-channel pipettes, fixed volume

Ordering information

Volume range	Color code	Rel. systematic error ¹⁾	Abs. systematic error ¹⁾	Rel. random error ¹⁾	Abs. random error ¹⁾	Order no.
Eppendorf Research® plus, single-channel, fixed						
10 µL	medium gray	±1.2 %	±0.12 µL	±0.6 %	±0.06 µL	3124 000 016
10 µL	yellow	±1.2 %	±0.12 µL	±0.6 %	±0.06 µL	3124 000 024
20 µL	light gray	±0.8 %	±0.16 µL	±0.3 %	±0.06 µL	3124 000 032
20 µL	yellow	±1.0 %	±0.2 µL	±0.3 %	±0.06 µL	3124 000 040
25 µL	yellow	±1.0 %	±0.25 µL	±0.3 %	±0.08 µL	3124 000 059
50 µL	yellow	±0.7 %	±0.35 µL	±0.3 %	±0.15 µL	3124 000 067
100 µL	yellow	±0.6 %	±0.6 µL	±0.2 %	±0.2 µL	3124 000 075
200 µL	yellow	±0.6 %	±1.2 µL	±0.2 %	±0.4 µL	3124 000 083
200 µL	blue	±0.6 %	±1.2 µL	±0.2 %	±0.4 µL	3124 000 091
250 µL	blue	±0.6 %	±1.5 µL	±0.2 %	±0.5 µL	3124 000 105
500 µL	blue	±0.6 %	±3.0 µL	±0.2 %	±1.0 µL	3124 000 113
1,000 µL	blue	±0.6 %	±6.0 µL	±0.2 %	±2.0 µL	3124 000 121

¹⁾ The error data, according to EN ISO 8655, only apply if original Eppendorf tips are used. Technical specifications are subject to change. Errors and omissions excepted.

Single-channel pipettes, variable volume

Ordering information

Volume range	Color code	Volume	Rel. systematic error ¹⁾	Abs. systematic error ¹⁾	Rel. random error ¹⁾	Abs. random error ¹⁾	Order no.
Eppendorf Research® plus, single-channel, variable, incl. epT.I.P.S.® Box							
0.1 – 2.5 µL	dark gray	0.1 µL	±48.0 %	±0.048 µL	±12.0 %	±0.012 µL	3123 000 012
		0.25 µL	±12.0 %	±0.03 µL	±6.0 %	±0.015 µL	
		1.25 µL	±2.5 %	±0.031 µL	±1.5 %	±0.019 µL	
		2.5 µL	±1.4 %	±0.035 µL	±0.7 %	±0.018 µL	
0.5 – 10 µL	medium gray	0.5 µL	±8.0 %	±0.04 µL	±5.0 %	±0.025 µL	3123 000 020
		1 µL	±2.5 %	±0.025 µL	±1.8 %	±0.018 µL	
		5 µL	±1.5 %	±0.075 µL	±0.8 %	±0.04 µL	
		10 µL	±1.0 %	±0.1 µL	±0.4 %	±0.04 µL	
2 – 20 µL	light gray	2 µL	±5.0 %	±0.1 µL	±1.5 %	±0.03 µL	3123 000 098
		10 µL	±1.2 %	±0.12 µL	±0.6 %	±0.06 µL	
		20 µL	±1.0 %	±0.2 µL	±0.3 %	±0.06 µL	
2 – 20 µL	yellow	2 µL	±5.0 %	±0.1 µL	±1.5 %	±0.03 µL	3123 000 039
		10 µL	±1.2 %	±0.12 µL	±0.6 %	±0.06 µL	
		20 µL	±1.0 %	±0.2 µL	±0.3 %	±0.06 µL	
10 – 100 µL	yellow	10 µL	±3.0 %	±0.3 µL	±1.0 %	±0.1 µL	3123 000 047
		50 µL	±1.0 %	±0.5 µL	±0.3 %	±0.15 µL	
		100 µL	±0.8 %	±0.8 µL	±0.2 %	±0.2 µL	
20 – 200 µL	yellow	20 µL	±2.5 %	±0.5 µL	±0.7 %	±0.14 µL	3123 000 055
		100 µL	±1.0 %	±1.0 µL	±0.3 %	±0.3 µL	
		200 µL	±0.6 %	±1.2 µL	±0.2 %	±0.4 µL	
30 – 300 µL	orange	30 µL	±2.5 %	±0.75 µL	±0.7 %	±0.21 µL	3123 000 101
		150 µL	±1.0 %	±1.5 µL	±0.3 %	±0.45 µL	
		300 µL	±0.6 %	±1.8 µL	±0.2 %	±0.6 µL	
100 – 1,000 µL	blue	100 µL	±3.0 %	±3.0 µL	±0.6 %	±0.6 µL	3123 000 063
		500 µL	±1.0 %	±5.0 µL	±0.2 %	±1.0 µL	
		1,000 µL	±0.6 %	±6.0 µL	±0.2 %	±2.0 µL	

¹⁾ The error data, according to EN ISO 8655, only apply if original Eppendorf tips are used. Technical specifications are subject to change. Errors and omissions excepted.

Ordering information

Volume range	Color code	Volume	Rel. systematic error ¹⁾	Abs. systematic error ¹⁾	Rel. random error ¹⁾	Abs. random error ¹⁾	Order no.
Eppendorf Research® plus, single-channel, variable, incl. epT.I.P.S.® sample bag							
0.25 – 2.5 mL	red	0.25 mL	±4.8 %	±0.012 mL	±1.2 %	±0.003 mL	3123 000 144
		1.25 mL	±0.8 %	±0.01 mL	±0.2 %	±0.0025 mL	
		2.5 mL	±0.6 %	±0.015 mL	±0.2 %	±0.005 mL	
0.5 – 5 mL	violet	0.5 mL	±2.4 %	±0.012 mL	±0.6 %	±0.003 mL	3123 000 071
		2.5 mL	±1.2 %	±0.03 mL	±0.25 %	±0.006 mL	
		5 mL	±0.6 %	±0.03 mL	±0.15 %	±0.008 mL	
1 – 10 mL	turquoise	1 mL	±3.0 %	±0.03 mL	±0.6 %	±0.006 mL	3123 000 080
		5 mL	±0.8 %	±0.04 mL	±0.2 %	±0.01 mL	
		10 mL	±0.6 %	±0.06 mL	±0.15 %	±0.015 mL	

¹⁾ The error data, according to EN ISO 8655, only apply if original Eppendorf tips are used. Technical specifications are subject to change. Errors and omissions excepted.



8-channel pipettes, variable volumes

Ordering information

Volume range	Color code	Volume	Rel. systematic error ¹⁾	Abs. systematic error ¹⁾	Rel. random error ¹⁾	Abs. random error ¹⁾	Order no.
Eppendorf Research® plus, 8-channel, variable, incl. epT.I.P.S.® Box							
0.5 – 10 µL	medium gray	0.5 µL	±12.0 %	±0.06 µL	±8.0 %	±0.04 µL	3125 000 010
		1 µL	±8.0 %	±0.08 µL	±5.0 %	±0.05 µL	
		5 µL	±4.0 %	±0.2 µL	±2.0 %	±0.1 µL	
		10 µL	±2.0 %	±0.2 µL	±1.0 %	±0.1 µL	
10 – 100 µL	yellow	10 µL	±3.0 %	±0.3 µL	±2.0 %	±0.2 µL	3125 000 036
		50 µL	±1.0 %	±0.5 µL	±0.8 %	±0.4 µL	
		100 µL	±0.8 %	±0.8 µL	±0.3 %	±0.3 µL	
30 – 300 µL	orange	30 µL	±3.0 %	±0.9 µL	±1.0 %	±0.3 µL	3125 000 052
		150 µL	±1.0 %	±1.5 µL	±0.5 %	±0.75 µL	
		300 µL	±0.6 %	±1.8 µL	±0.3 %	±0.9 µL	
120 – 1,200 µL	green	120 µL	±6.0 %	±7.2 µL	±0.9 %	±1.08 µL	3125 000 214
		600 µL	±2.7 %	±16.2 µL	±0.4 %	±2.4 µL	
		1,200 µL	±1.2 %	±14.4 µL	±0.3 %	±3.6 µL	

¹⁾ The error data, according to EN ISO 8655, only apply if original Eppendorf tips are used. Technical specifications are subject to change. Errors and omissions excepted.

For 8-channel pipettes please choose standard epT.I.P.S., see pages 58 - 65

Order info of new Pipette „Move It“ see page 41



Eppendorf Research® plus

12-channel pipettes, variable volumes

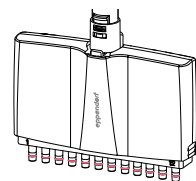

Ordering information

Volume range	Color code	Volume	Rel. systematic error ¹⁾	Abs. systematic error ¹⁾	Rel. random error ¹⁾	Abs. random error ¹⁾	Order no.
Eppendorf Research® plus, 12-channel, variable, incl. epT.I.P.S.® Box							
0.5 – 10 µL	■ medium gray	0.5 µL	±12,0 %	±0,06 µL	±8,0 %	±0,04 µL	3125 000 028
		1 µL	±8,0 %	±0,08 µL	±5,0 %	±0,05 µL	
		5 µL	±4,0 %	±0,2 µL	±2,0 %	±0,1 µL	
		10 µL	±2,0 %	±0,2 µL	±1,0 %	±0,1 µL	
10 – 100 µL	■ yellow	10 µL	±3,0 %	±0,3 µL	±2,0 %	±0,2 µL	3125 000 044
		50 µL	±1,0 %	±0,5 µL	±0,8 %	±0,4 µL	
		100 µL	±0,8 %	±0,8 µL	±0,3 %	±0,3 µL	
30 – 300 µL	■ orange	30 µL	±3,0 %	±0,9 µL	±1,0 %	±0,3 µL	3125 000 060
		150 µL	±1,0 %	±1,5 µL	±0,5 %	±0,75 µL	
		300 µL	±0,6 %	±1,8 µL	±0,3 %	±0,9 µL	
New 120 – 1,200 µL	■ green	120 µL	±6,0 %	±7,2 µL	±0,9 %	±1,08 µL	3125 000 222
		600 µL	±2,7 %	±16,2 µL	±0,4 %	±2,4 µL	
		1,200 µL	±1,2 %	±14,4 µL	±0,3 %	±3,6 µL	

¹⁾ The error data, according to EN ISO 8655, only apply if original Eppendorf tips are used. Technical specifications are subject to change. Errors and omissions excepted.

For 12-channel pipettes please choose standard epT.I.P.S., see pages 58 - 65

Order info of new Pipette „Move It“ see page 41

16-channel pipettes, variable volume, for 384-well plates

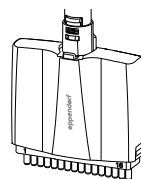

Ordering information

Volume range	Color code	Volume	Rel. systematic error ¹⁾	Abs. systematic error ¹⁾	Rel. random error ¹⁾	Abs. random error ¹⁾	Order no.
Eppendorf Research® plus, 16-channel, variable, incl. epT.I.P.S.® Box							
1 – 20 µL	■ light pink	1 µL	±12 %	±0.12 µL	±8 %	±0.08 µL	3125 000 079
		2 µL	±8 %	±0.16 µL	±5 %	±0.1 µL	
		10 µL	±4 %	±0.4 µL	±2 %	±0.2 µL	
		20 µL	±2 %	±0.4 µL	±1 %	±0.2 µL	
5 – 100 µL	■ light yellow	5 µL	±6 %	±0.3 µL	±4 %	±0.2 µL	3125 000 095
		10 µL	±3 %	±0.3 µL	±2 %	±0.2 µL	
		50 µL	±1.2 %	±0.6 µL	±0.8 %	±0.4 µL	
		100 µL	±1 %	±1 µL	±0.6 %	±0.6 µL	

¹⁾ The error data, according to EN ISO 8655, only apply if original Eppendorf tips are used. Technical specifications are subject to change. Errors and omissions excepted.

For 16-channel pipettes please choose epT.I.P.S. 384, see pages 64 - 65

Order info of new Pipette „Move It“ see page 41

24-channel pipettes, variable volume, for 384-well plates

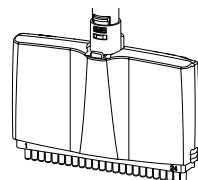

Ordering information

Volume range	Color code	Volume	Rel. systematic error ¹⁾	Abs. systematic error ¹⁾	Rel. random error ¹⁾	Abs. random error ¹⁾	Order no.
Eppendorf Research® plus, 24-channel, variable, incl. epT.I.P.S.® Box							
1 – 20 µL	■ light pink	1 µL	±12 %	±0.12 µL	±8 %	±0.08 µL	3125 000 087
		2 µL	±8 %	±0.16 µL	±5 %	±0.1 µL	
		10 µL	±4 %	±0.4 µL	±2 %	±0.2 µL	
		20 µL	±2 %	±0.4 µL	±1 %	±0.2 µL	
5 – 100 µL	■ light yellow	5 µL	±6 %	±0.3 µL	±4 %	±0.2 µL	3125 000 109
		10 µL	±3 %	±0.3 µL	±2 %	±0.2 µL	
		50 µL	±1.2 %	±0.6 µL	±0.8 %	±0.4 µL	
		100 µL	±1 %	±1 µL	±0.6 %	±0.6 µL	

¹⁾ The error data, according to EN ISO 8655, only apply if original Eppendorf tips are used. Technical specifications are subject to change. Errors and omissions excepted.

For 24-channel pipettes please choose epT.I.P.S. 384 see pages 64 - 65

Order info of new Pipette „Move It“ see page 41

Technical specifications subject to change.



Eppendorf Research® plus 3-pack

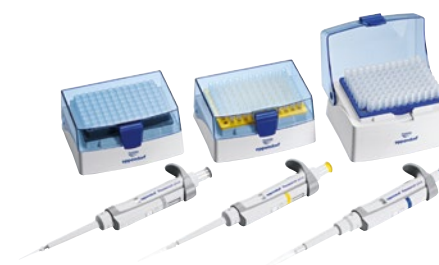

Get your lab up and running fast with our 3-pack of Research plus pipettes

Get ready for a threefold enjoyable pipetting experience with one of the most advanced and ergonomic pipettes in the world. The economic Research plus triple-pack is available in three different versions. In addition to three Research plus pipettes, each pack contains one set of matching Eppendorf tips and one of the popular Eppendorf ballpoint pens.

Ordering information

Eppendorf Research® plus 3-pack	Order no.
Eppendorf Research® plus 3-pack , single-channel, variable, incl. epT.I.P.S.® Box or sample bag and ballpoint pen	
Option 1: 0.5 – 10 µL, 10 – 100 µL, 100 – 1,000 µL	3123 000 900
Option 2: 2 – 20 µL yellow, 20 – 200 µL, 100 – 1,000 µL	3123 000 918
Option 3: 100 – 1,000 µL, 0.5 – 5 mL, 1 – 10 mL	3123 000 926

Eppendorf Tip-tub

Tip: the Eppendorf Tip-tub reagent reservoir is suitable for all 8, 12, 16 and 24-channel pipettes and all Eppendorf Move It™ pipettes. See below for ordering information.



Accessories

Accessories

Description	Order no.
Eppendorf Research® plus red adjustment seal ADJ , 1 set = 5 pieces	3120 636 005
Adjustment tool , for changing factory or secondary user adjustment	3120 633 006
Safety plug tools , for changing the factory adjustment, 5 pieces	3120 639 004
Protection filter 5 mL , 10 filters with 1 filter sleeve, for 0.5 – 5 mL variable, color code: violet	4920 623 005
Protection filter 10 mL , 10 filters with 1 filter sleeve, for 1 – 10 mL variable, color code: turquoise	4920 624 001
O-ring , red, for multi-channel lower parts, 5 – 100 µL, 15 – 300 µL (1 set = 24 pcs)	3122 611 000
Multi-channel tool , for cutting the O-rings on the tip cone of multi-channel lower parts, 5 – 100 µL or 15 – 300 µL	3122 610 003
Pipette wrench 2 mL – 10 mL	3120 634 002
Locking ring , to prevent spring action with single-channel pipettes, 2.5 µL – 1,000 µL	3120 635 009
Locking clip for 8 channel pipette , to prevent spring action of tip cones, 2 pieces	3122 612 006
Locking clip for 12 channel pipette , to prevent spring action of tip cones, 3 pieces	3122 613 002
Reagent reservoir Tip-Tub , autoclavable reservoir for the aspiration of liquids with multi-channel pipettes, 1 set = 10 reservoirs and 10 lids	0030 058 607
Pipette grease with lint-free applicator	0013 022 153
Eppendorf TrackIT , RFID Reader and Software	3903 000 014

Eppendorf Reference® 2

Extraordinary precision and accuracy – Eppendorf's premium pipette

Besides improved ergonomics the design focus lays on providing the most accurate results possible, optimum user safety, reliability and robustness for a long service life. The innovative single button operation is not only fast and easy, but it also allows active aerosol¹⁾ reduction and thus protects the user, the sample and the pipette. The sturdy handle manufactured with stainless steel protects the pipette from impact and in combination with the spring loaded bumpers the Reference 2 is likely to stay within calibration even if it takes a fall. These high levels of accuracy make the Reference 2 ideal for use with precious liquids, or in any application requiring extremely high levels of accuracy. When there can be no compromise on quality and reproducibility, Eppendorf's Reference 2 is an ideal instrument for these liquid handling applications.

¹⁾ An aerosol is a colloid of fine solid particles or liquid droplets in air or another gas.



Product features

- > The one-button operation offers fast and ergonomic handling with reduced operating effort and active aerosol reduction. To avoid accidental tip ejection a clear haptic feedback is provided
- > The spring-loaded tip cone improves user-to-user reproducibility and improved ergonomics by lowering tip attachment force
- > The Reference 2 multi-channel offers high flexibility incl. a spring-loaded tip cone which can be switched on/off optionally
- > The secondary adjustment supports the easy adjustment of your Reference 2 for the most accurate pipetting of different liquids or other external conditions without the need for a full calibration
- > The outstanding precision and accuracy of Reference 2 provides reliable results
- > 4-digit volume display with magnifying window to allow for easier volume identification
- > The unique smooth surface guarantees simple cleaning. In addition to the full autoclavability of this pipette, decontamination is as easy and efficient as never before. This is the ideal pipette when working under sterile conditions
- > An embedded RFID chip contains all relevant data regarding the pipette and offers with Eppendorf TrackIT a simple identification and documentation
- > Available as single-channel pipette in fixed or variable volume as well as 8 and 12-channel pipette



User-friendly secondary adjustment

For liquids other than aqueous solutions. Leaving the factory settings untouched, a reset back to manufacturer setting is just as quick and easy.



Exquisite stainless steel upper part

Equips the Reference 2 with outstanding robustness at potential impact sites. It includes quick volume setting and secure volume lock.

Applications

- > Forward pipetting
- > Reverse pipetting
- > Removal of supernatants
- > Sample mixing
- > Phase extraction
- > Filling of plates, gels, and reaction vessels

For more information go to www.eppendorf.com/Reference2

Technical specifications subject to change.

Single-channel pipettes, fixed volume

Ordering information

Volume range	Color code	Rel. systematic error ¹⁾	Abs. systematic error ¹⁾	Rel. random error ¹⁾	Abs. random error ¹⁾	Order no.
Eppendorf Reference® 2, single-channel, fixed						
1 µL	dark gray	±2.5 %	±0.025 µL	±1.8 %	±0.018 µL	4925 000 014
2 µL	dark gray	±2.0 %	±0.04 µL	±1.2 %	±0.024 µL	4925 000 022
5 µL	medium gray	±1.2 %	±0.06 µL	±0.6 %	±0.03 µL	4925 000 030
10 µL	medium gray	±1.0 %	±0.1 µL	±0.5 %	±0.05 µL	4925 000 049
10 µL	yellow	±1.2 %	±0.12 µL	±0.5 %	±0.05 µL	4925 000 057
20 µL	light gray	±0.8 %	±0.16 µL	±0.3 %	±0.06 µL	4925 000 065
20 µL	yellow	±1.0 %	±0.2 µL	±0.3 %	±0.06 µL	4925 000 073
25 µL	yellow	±1.0 %	±0.25 µL	±0.3 %	±0.075 µL	4925 000 081
50 µL	yellow	±0.7 %	±0.35 µL	±0.3 %	±0.15 µL	4925 000 090
100 µL	yellow	±0.6 %	±0.6 µL	±0.2 %	±0.2 µL	4925 000 103
200 µL	yellow	±0.6 %	±1.2 µL	±0.2 %	±0.4 µL	4925 000 111
200 µL	blue	±0.6 %	±1.2 µL	±0.2 %	±0.4 µL	4925 000 120
250 µL	blue	±0.6 %	±1.5 µL	±0.2 %	±0.5 µL	4925 000 138
500 µL	blue	±0.6 %	±3.0 µL	±0.2 %	±1.0 µL	4925 000 146
1,000 µL	blue	±0.6 %	±6.0 µL	±0.2 %	±2.0 µL	4925 000 154
2 mL	red	±0.6 %	±0.012 mL	±0.2 %	±0.004 mL	4925 000 162
2.5 mL	red	±0.6 %	±0.015 mL	±0.2 %	±0.005 mL	4925 000 170

¹⁾ The error data, according to EN ISO 8655, only apply if original Eppendorf tips are used. Technical specifications are subject to change. Errors and omissions excepted.

Single-channel pipettes, variable volume

Ordering information

Volume range	Color code	Volume	Rel. systematic error ¹⁾	Abs. systematic error ¹⁾	Rel. random error ¹⁾	Abs. random error ¹⁾	Order no.
Eppendorf Reference® 2, single-channel, variable, incl. epT.I.P.S.® Box							
0.1 – 2.5 µL	dark gray	0.1 µL	±48.0 %	±0.048 µL	±12.0 %	±0.012 µL	4924 000 010
		0.25 µL	±12.0 %	±0.03 µL	±6.0 %	±0.015 µL	
		1.25 µL	±2.5 %	±0.031 µL	±1.5 %	±0.019 µL	
		2.5 µL	±1.4 %	±0.035 µL	±0.7 %	±0.018 µL	
0.5 – 10 µL	medium gray	0.5 µL	±8.0 %	±0.04 µL	±5.0 %	±0.025 µL	4924 000 029
		1.0 µL	±2.5 %	±0.025 µL	±1.8 %	±0.018 µL	
		5.0 µL	±1.5 %	±0.075 µL	±0.8 %	±0.04 µL	
		10 µL	±1.0 %	±0.10 µL	±0.4 %	±0.04 µL	
2 – 20 µL	light gray	2.0 µL	±3.0 %	±0.06 µL	±1.5 %	±0.03 µL	4924 000 037
		10 µL	±1.0 %	±0.10 µL	±0.6 %	±0.06 µL	
		20 µL	±0.8 %	±0.16 µL	±0.3 %	±0.06 µL	
2 – 20 µL	yellow	2.0 µL	±5.0 %	±0.10 µL	±1.5 %	±0.03 µL	4924 000 045
		10 µL	±1.2 %	±0.12 µL	±0.6 %	±0.06 µL	
		20 µL	±1.0 %	±0.2 µL	±0.3 %	±0.06 µL	
10 – 100 µL	yellow	10 µL	±3.0 %	±0.3 µL	±0.7 %	±0.07 µL	4924 000 053
		50 µL	±1.0 %	±0.5 µL	±0.3 %	±0.15 µL	
		100 µL	±0.8 %	±0.8 µL	±0.2 %	±0.2 µL	
20 – 200 µL	yellow	20 µL	±2.5 %	±0.5 µL	±0.7 %	±0.14 µL	4924 000 061
		100 µL	±1.0 %	±1.0 µL	±0.3 %	±0.3 µL	
		200 µL	±0.6 %	±1.2 µL	±0.2 %	±0.4 µL	
30 – 300 µL	orange	30 µL	±2.5 %	±0.75 µL	±0.7 %	±0.21 µL	4924 000 070
		150 µL	±1.0 %	±1.5 µL	±0.3 %	±0.45 µL	
		300 µL	±0.6 %	±1.8 µL	±0.2 %	±0.6 µL	
100 – 1,000 µL	blue	100 µL	±3.0 %	±3.0 µL	±0.6 %	±0.6 µL	4924 000 088
		500 µL	±1.0 %	±5.0 µL	±0.2 %	±1.0 µL	
		1,000 µL	±0.6 %	±6.0 µL	±0.2 %	±2.0 µL	
Eppendorf Reference® 2, single-channel, variable, incl. epT.I.P.S.® sample bag							
0.25 – 2.5 mL	red	0.25 mL	±4.8 %	±0.012 mL	±1.2 %	±0.003 mL	4924 000 096
		1.25 mL	±0.8 %	±0.010 mL	±0.2 %	±0.0025 mL	
		2.5 mL	±0.6 %	±0.015 mL	±0.2 %	±0.005 mL	
0.5 – 5 mL	violet	0.5 mL	±2.4 %	±0.012 mL	±0.6 %	±0.003 mL	4924 000 100
		2.5 mL	±1.2 %	±0.030 mL	±0.25 %	±0.006 mL	
		5.0 mL	±0.6 %	±0.030 mL	±0.15 %	±0.0075 mL	
1 – 10 mL	turquoise	1.0 mL	±3.0 %	±0.030 mL	±0.6 %	±0.006 mL	4924 000 118
		5.0 mL	±0.8 %	±0.040 mL	±0.2 %	±0.010 mL	
		10.0 mL	±0.6 %	±0.060 mL	±0.15 %	±0.015 mL	

¹⁾ The error data, according to EN ISO 8655, only apply if original Eppendorf tips are used. Technical specifications are subject to change. Errors and omissions excepted.

Your local distributor: www.eppendorf.com/contact
Eppendorf AG · Barkhausenweg 1 · 22339 Hamburg · Germany · eppendorf@eppendorf.com · www.eppendorf.com · www.eppendorf.com/eshop

Eppendorf Reference® 2

8-channel pipettes and 12-channel pipettes, variable volumes

Ordering information							
Volume range	Color code	Volume	Rel. systematic error ¹⁾	Abs. systematic error ¹⁾	Rel. random error ¹⁾	Abs. random error ¹⁾	Order no.
Eppendorf Reference® 2, 8-channel, variable, incl. epT.I.P.S.® Box							
0.5 – 10 µL	■ medium gray	0.5 µL	±12.0 %	±0.06 µL	±8.0 %	±0.04 µL	4926 000 018
		1.0 µL	±8.0 %	±0.08 µL	±5.0 %	±0.05 µL	
		5.0 µL	±4.0 %	±0.2 µL	±2.0 %	±0.1 µL	
		10 µL	±2.0 %	±0.2 µL	±1.0 %	±0.1 µL	
10 – 100 µL	■ yellow	10 µL	±3.0 %	±0.3 µL	±2.0 %	±0.2 µL	4926 000 034
		50 µL	±1.0 %	±0.5 µL	±0.8 %	±0.4 µL	
		100 µL	±0.8 %	±0.8 µL	±0.3 %	±0.3 µL	
30 – 300 µL	■ orange	30 µL	±3.0 %	±0.9 µL	±1.0 %	±0.3 µL	4926 000 050
		150 µL	±1.0 %	±1.5 µL	±0.5 %	±0.75 µL	
		300 µL	±0.6 %	±1.8 µL	±0.3 %	±0.9 µL	
Eppendorf Reference® 2, 12-channel, variable, incl. epT.I.P.S.® Box							
0.5 – 10 µL	■ medium gray	0.5 µL	±12.0 %	±0.06 µL	±8.0 %	±0.04 µL	4926 000 026
		1.0 µL	±8.0 %	±0.08 µL	±5.0 %	±0.05 µL	
		5.0 µL	±4.0 %	±0.2 µL	±2.0 %	±0.1 µL	
		10 µL	±2.0 %	±0.2 µL	±1.0 %	±0.1 µL	
10 – 100 µL	■ yellow	10 µL	±3.0 %	±0.3 µL	±2.0 %	±0.2 µL	4926 000 042
		50 µL	±1.0 %	±0.5 µL	±0.8 %	±0.4 µL	
		100 µL	±0.8 %	±0.8 µL	±0.3 %	±0.3 µL	
30 – 300 µL	■ orange	30 µL	±3.0 %	±0.9 µL	±1.0 %	±0.3 µL	4926 000 069
		150 µL	±1.0 %	±1.5 µL	±0.5 %	±0.75 µL	
		300 µL	±0.6 %	±1.8 µL	±0.3 %	±0.9 µL	

¹⁾ The error data, according to EN ISO 8655, only apply if original Eppendorf tips are used. Technical specifications are subject to change. Errors and omissions excepted.

Ordering information		Order no.
Eppendorf Reference® 2, 3-pack		
Eppendorf Reference® 2, 3-pack, single-channel, variable, incl. epT.I.P.S.® Box or sample bag and ballpoint pen		
Option 1: 0.5 – 10 µL, 10 – 100 µL, 100 – 1,000 µL		4924 000 908
Option 2: 2 – 20 µL yellow, 20 – 200 µL, 100 – 1,000 µL		4924 000 916
Option 3: 100 – 1,000 µL, 0.5 – 5 mL, 1 – 10 mL		4924 000 924

Accessories		Order no.
Description		
Red adjustment seal ADJ, incl. pin for removing the inserted seal, 1 set = 5 pieces		4920 626 004
Eppendorf Reference® 2 red safety plug, incl. pin for removing the inserted safety plug, 1 set = 5 pieces		4920 625 008
Adjustment tool, for changing factory or secondary user adjustment		3120 633 006
Protection filter 2.5 mL, 10 filters with 1 filter sleeve, 0.25 – 2.5 mL variable, 2 mL fixed volume and 2.5 mL fixed volume, color code: red		4920 622 009
Protection filter 5 mL, 10 filters with 1 filter sleeve, for 0.5 – 5 mL variable, color code: violet		4920 623 005
Protection filter 10 mL, 10 filters with 1 filter sleeve, for 1 – 10 mL variable, color code: turquoise		4920 624 001
Multi-channel tool, for cutting the O-rings on the tip cone of multi-channel lower parts, 5 – 100 µL or 15 – 300 µL		3122 610 003
Pipette wrench 2 mL – 10 mL		3120 634 002
Locking ring, to prevent spring action with single-channel pipettes, 2.5 µL – 1,000 µL		3120 635 009
Reagent reservoir Tip-Tub, autoclavable reservoir for the aspiration of liquids with multi-channel pipettes, 1 set = 10 reservoirs and 10 lids		0030 058 607
Pipette grease with lint-free applicator		0013 022 153
Eppendorf TrackIT, RFID Reader and Software		3903 000 014

► Pipette service and maintenance contracts can be found on page 376. Pipette tips can be found on page 58 onward.

! For more information go to www.eppendorf.com/Reference2

Eppendorf Xplorer®/Eppendorf Xplorer® plus

Simple, fast and precise with untiring battery power – You deserve it!

People who give 100 % every day deserve the best tools and the best equipment. You work on demanding problems, and important decisions depend on the results of your work. The Eppendorf Xplorer/Xplorer plus is an electronic air-cushion pipette, supported by the Eppendorf PhysioCare Concept®. Using it means your work achieves a new level of simplicity, precision and reproducibility, with no more delays due to complicated programming or inflexible processes. The Xplorer pipettes are the ideal instrument if you need precisely adjustable parameters, reproducible and accurate results while eliminating user-to-user variability and experiencing fatigue-free pipetting.



Product features

- > Air-cushion pipette for accurate aspiration and dispensing of aqueous solutions from 0.5 µL to 10 mL
- > Individual programming and settings to achieve a new level of simplicity
- > Selection dial for quick and easy selection of functions
- > Multi-functional rocker with up is up and down is down functionality
- > Spring-loaded tip cone (not available for 2.5 mL, 5 mL and 10 mL pipettes) for minimal tip attachment forces helps to reduce stress
- > Powerful rechargeable battery for up to 8 hours work without the need for recharging
- > Adjust your pipette in seconds for better accuracy when pipetting various difficult liquids like ethanol or even when pipetting at high altitudes
- > Lower part of pipette can be autoclaved to ensure decontamination
- > 9 different languages: Chinese, Dutch, English, French, German, Italian, Japanese, Portuguese and Spanish
- > Enjoy excellent flexibility and choose among variable single-channel, 8, 12, 16 and 24-channel pipettes or multichannel pipettes with adjustable cone distance (see page 41)

Modes of operation	Xplorer	Xplorer plus
Pipetting (Pip): Aspiration and dispensing of liquids.	■	■
Manual Pipetting (Man): Aspiration of liquid can be manually stopped prior to reaching the max set volume; used for volume determination.	■	■
Pipetting and Mixing (P/M): Samples are aspirated and dispensed automatically followed by an adjustable number of mixing cycles.	■	■
Dispensing (Dis): Dispensing of liquid in equal partial volumes.	■	■
Automatic Dispensing (Ads): Automatic dispensing of liquid in equal partial volumes at user-defined time intervals.	■	■
Special mode (Spc) – Multi Aspiration: Consecutive aspiration for pooling into one pipette tip.		■
Special mode (Spc) – Sequential Dispensing: Aspiration of liquid followed by dispensing it in up to 10 user-defined volume steps.		■
Special mode (Spc) – Reverse Pipetting: Over-aspiration of liquid followed by a regular dispensing step. Ideal for non-aqueous solutions.		■
Special mode (Spc) – Diluting: Aspiration of a diluent and a sample separated by an air bubble.		■
Special mode (Spc) – Sequential pipetting: Pipetting of up to 10 user-defined volumes in sequential order.		■
Fix Volume (Fix): Save up to 10 of your most frequently used volumes including aspiration and dispense speed for ease of operation.		■
Programming (Prg): Save up to 10 of your most common methods with up to 4 different pipetting steps each.		■
Options (Opt): Save favorite settings, set service intervals, activate key lock and more.	■	■

! For more information go to www.eppendorf.com/Xplorer



Eppendorf Xplorer®

Single-channel pipettes

Ordering information

Volume range	Color code	Volume	Rel. systematic error ¹⁾	Abs. systematic error ¹⁾	Rel. random error ¹⁾	Abs. random error ¹⁾	Order no.
Eppendorf Xplorer®, single-channel, variable							
0.5 – 10 µL	medium gray	0.5 µL	±6.0 %	±0.03 µL	±3.0 %	±0.015 µL	4861 000 015
		1 µL	±2.5 %	±0.025 µL	±1.8 %	±0.018 µL	
		5 µL	±1.5 %	±0.075 µL	±0.8 %	±0.04 µL	
		10 µL	±1.0 %	±0.1 µL	±0.4 %	±0.04 µL	
1 – 20 µL	light gray	2 µL	±5.0 %	±0.1 µL	±1.5 %	±0.03 µL	4861 000 017
		10 µL	±1.2 %	±0.12 µL	±0.6 %	±0.06 µL	
		20 µL	±1.0 %	±0.2 µL	±0.3 %	±0.06 µL	
5 – 100 µL	yellow	5 µL	±4.0 %	±0.2 µL	±2.0 %	±0.1 µL	4861 000 023
		10 µL	±2.0 %	±0.2 µL	±1.0 %	±0.1 µL	
		50 µL	±1.0 %	±0.5 µL	±0.3 %	±0.15 µL	
		100 µL	±0.8 %	±0.8 µL	±0.2 %	±0.2 µL	
10 – 200 µL	yellow	20 µL	±2.5 %	±0.5 µL	±0.7 %	±0.14 µL	4861 000 027
		100 µL	±1.0 %	±1.0 µL	±0.3 %	±0.3 µL	
		200 µL	±0.6 %	±1.2 µL	±0.2 %	±0.4 µL	
15 – 300 µL	orange	15 µL	±5.0 %	±0.75 µL	±1.4 %	±0.21 µL	4861 000 031
		30 µL	±2.5 %	±0.75 µL	±0.7 %	±0.21 µL	
		150 µL	±1.0 %	±1.5 µL	±0.3 %	±0.45 µL	
		300 µL	±0.6 %	±1.8 µL	±0.2 %	±0.6 µL	
50 – 1,000 µL	blue	50 µL	±6.0 %	±3 µL	±1.0 %	±0.5 µL	4861 000 040
		100 µL	±3.0 %	±3 µL	±0.6 %	±0.6 µL	
		500 µL	±1.0 %	±5 µL	±0.2 %	±1 µL	
		1,000 µL	±0.6 %	±6 µL	±0.2 %	±2 µL	
0.1 – 2.5 mL	red	250 µL	±4.8 %	±12 µL	±1.2 %	±3.0 µL	4861 000 044
		1,250 µL	±0.8 %	±10 µL	±0.2 %	±2.5 µL	
		2,500 µL	±0.6 %	±15 µL	±0.2 %	±5.0 µL	
0.2 – 5 mL	violet	250 µL	±4.8 %	±12 µL	±1.2 %	±3 µL	4861 000 058
		500 µL	±3.0 %	±15 µL	±0.6 %	±3 µL	
		2,500 µL	±1.2 %	±30 µL	±0.25 %	±6.25 µL	
		5,000 µL	±0.6 %	±30 µL	±0.15 %	±7.5 µL	
0.5 – 10 mL	turquoise	500 µL	±6.0 %	±30 µL	±1.2 %	±6 µL	4861 000 066
		1,000 µL	±3.0 %	±30 µL	±0.6 %	±6 µL	
		5,000 µL	±0.8 %	±40 µL	±0.2 %	±10 µL	
		10,000 µL	±0.6 %	±60 µL	±0.15 %	±15 µL	

¹⁾ The error data, according to EN ISO 8655, only apply if original Eppendorf tips are used. Technical specifications are subject to change. Errors and omissions excepted.



8-channel pipettes

Ordering information

Volume range	Color code	Volume	Rel. systematic error ¹⁾	Abs. systematic error ¹⁾	Rel. random error ¹⁾	Abs. random error ¹⁾	Order no.
Eppendorf Xplorer®, 8-channel, variable							
0.5 – 10 µL	medium gray	0.5 µL	±10.0 %	±0.05 µL	±6.0 %	±0.03 µL	4861 000 104
		1 µL	±5.0 %	±0.05 µL	±3.0 %	±0.03 µL	
		5 µL	±3.0 %	±0.15 µL	±1.5 %	±0.075 µL	
		10 µL	±2.0 %	±0.2 µL	±0.8 %	±0.08 µL	
5 – 100 µL	yellow	5 µL	±6.0 %	±0.3 µL	±4.0 %	±0.2 µL	4861 000 120
		10 µL	±2.0 %	±0.2 µL	±2.0 %	±0.2 µL	
		50 µL	±1.0 %	±0.5 µL	±0.8 %	±0.4 µL	
		100 µL	±0.8 %	±0.8 µL	±0.25 %	±0.25 µL	
15 – 300 µL	orange	15 µL	±6.0 %	±0.9 µL	±2.0 %	±0.3 µL	4861 000 147
		30 µL	±2.5 %	±0.75 µL	±1.0 %	±0.3 µL	
		150 µL	±1.0 %	±1.5 µL	±0.5 %	±0.75 µL	
		300 µL	±0.6 %	±1.8 µL	±0.25 %	±0.75 µL	
50 – 1,200 µL	green	50 µL	±8.0 %	±4.0 µL	±1.2 %	±0.6 µL	4861 000 163
		120 µL	±6.0 %	±7.2 µL	±0.9 %	±1.08 µL	
		600 µL	±2.7 %	±16.2 µL	±0.4 %	±2.4 µL	
		1,200 µL	±1.2 %	±14.4 µL	±0.3 %	±3.6 µL	

¹⁾ The error data, according to EN ISO 8655, only apply if original Eppendorf tips are used. Technical specifications are subject to change. Errors and omissions excepted.

For 8-channel pipettes please choose standard eP.T.I.P.S., see pages 58 - 65

12-channel pipettes

Ordering information

Volume range	Color code	Volume	Rel. systematic error ¹⁾	Abs. systematic error ¹⁾	Rel. random error ¹⁾	Abs. random error ¹⁾	Order no.
Eppendorf Xplorer®, 12-channel, variable							
0.5 – 10 µL	medium gray	0.5 µL	±10.0 %	±0.05 µL	±6.0 %	±0.03 µL	4861 000 112
		1 µL	±5.0 %	±0.05 µL	±3.0 %	±0.03 µL	
		5 µL	±3.0 %	±0.15 µL	±1.5 %	±0.075 µL	
		10 µL	±2.0 %	±0.2 µL	±0.8 %	±0.08 µL	
5 – 100 µL	yellow	5 µL	±6.0 %	±0.3 µL	±4.0 %	±0.2 µL	4861 000 139
		10 µL	±2.0 %	±0.2 µL	±2.0 %	±0.2 µL	
		50 µL	±1.0 %	±0.5 µL	±0.8 %	±0.4 µL	
		100 µL	±0.8 %	±0.8 µL	±0.25 %	±0.25 µL	
15 – 300 µL	orange	15 µL	±6.0 %	±0.9 µL	±2.0 %	±0.3 µL	4861 000 155
		30 µL	±2.5 %	±0.75 µL	±1.0 %	±0.3 µL	
		150 µL	±1.0 %	±1.5 µL	±0.5 %	±0.75 µL	
		300 µL	±0.6 %	±1.8 µL	±0.25 %	±0.75 µL	
50 – 1,200 µL	green	50 µL	±8.0 %	±4.0 µL	±1.2 %	±0.6 µL	4861 000 171
		120 µL	±6.0 %	±7.2 µL	±0.9 %	±1.08 µL	
		600 µL	±2.7 %	±16.2 µL	±0.4 %	±2.4 µL	
		1,200 µL	±1.2 %	±14.4 µL	±0.3 %	±3.6 µL	

¹⁾ The error data, according to EN ISO 8655, only apply if original Eppendorf tips are used. Technical specifications are subject to change. Errors and omissions excepted.

For 12-channel pipettes please choose standard eP.T.I.P.S., see pages 58 - 65

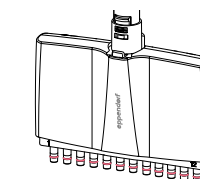

Eppendorf Xplorer® plus

Single-channel pipettes

Ordering information

Volume range	Color code	Volume	Rel. systematic error ¹⁾	Abs. systematic error ¹⁾	Rel. random error ¹⁾	Abs. random error ¹⁾	Order no.
Eppendorf Xplorer® plus, single-channel, variable							
0.5 – 10 µL	medium gray	0.5 µL	±6.0 %	±0.03 µL	±3.0 %	±0.015 µL	4861 000 708
		1 µL	±2.5 %	±0.025 µL	±1.8 %	±0.018 µL	
		5 µL	±1.5 %	±0.075 µL	±0.8 %	±0.04 µL	
		10 µL	±1.0 %	±0.1 µL	±0.4 %	±0.04 µL	
1 – 20 µL	light gray	2 µL	±5.0 %	±0.1 µL	±1.5 %	±0.03 µL	4861 000 710
		10 µL	±1.2 %	±0.12 µL	±0.6 %	±0.06 µL	
		20 µL	±1.0 %	±0.2 µL	±0.3 %	±0.06 µL	
5 – 100 µL	yellow	5 µL	±4.0 %	±0.2 µL	±2.0 %	±0.1 µL	4861 000 716
		10 µL	±2.0 %	±0.2 µL	±1.0 %	±0.1 µL	
		50 µL	±1.0 %	±0.5 µL	±0.3 %	±0.15 µL	
		100 µL	±0.8 %	±0.8 µL	±0.2 %	±0.2 µL	
10 – 200 µL	yellow	20 µL	±2.5 %	±0.5 µL	±0.7 %	±0.14 µL	4861 000 720
		100 µL	±1.0 %	±1.0 µL	±0.3 %	±0.3 µL	
		200 µL	±0.6 %	±1.2 µL	±0.2 %	±0.4 µL	
15 – 300 µL	orange	15 µL	±5.0 %	±0.75 µL	±1.4 %	±0.21 µL	4861 000 724
		30 µL	±2.5 %	±0.75 µL	±0.7 %	±0.21 µL	
		150 µL	±1.0 %	±1.5 µL	±0.3 %	±0.45 µL	
		300 µL	±0.6 %	±1.8 µL	±0.2 %	±0.6 µL	
50 – 1,000 µL	blue	50 µL	±6.0 %	±3 µL	±1.0 %	±0.5 µL	4861 000 732
		100 µL	±3.0 %	±3 µL	±0.6 %	±0.6 µL	
		500 µL	±1.0 %	±5 µL	±0.2 %	±1 µL	
		1,000 µL	±0.6 %	±6 µL	±0.2 %	±2 µL	
0.1 – 2.5 mL	red	250 µL	±4.8 %	±12 µL	±1.2 %	±3.0 µL	4861 000 736
		1,250 µL	±0.8 %	±10 µL	±0.2 %	±2.5 µL	
		2,500 µL	±0.6 %	±15 µL	±0.2 %	±5.0 µL	
0.2 – 5 mL	violet	200 µL	±4.8 %	±12 µL	±1.2 %	±3 µL	4861 000 740
		500 µL	±3.0 %	±15 µL	±0.6 %	±3 µL	
		2,500 µL	±1.2 %	±30 µL	±0.25 %	±6.25 µL	
		5,000 µL	±0.6 %	±30 µL	±0.15 %	±7.5 µL	
0.5 – 10 mL	turquoise	500 µL	±6.0 %	±30 µL	±1.2 %	±6 µL	4861 000 759
		1,000 µL	±3.0 %	±30 µL	±0.6 %	±6 µL	
		5,000 µL	±0.8 %	±40 µL	±0.2 %	±10 µL	
		10,000 µL	±0.6 %	±60 µL	±0.15 %	±15 µL	

¹⁾ The error data, according to EN ISO 8655, only apply if original Eppendorf tips are used. Technical specifications are subject to change. Errors and omissions excepted.



8-channel pipettes

Ordering information

Volume range	Color code	Volume	Rel. systematic error ¹⁾	Abs. systematic error ¹⁾	Rel. random error ¹⁾	Abs. random error ¹⁾	Order no.
Eppendorf Xplorer® plus, 8-channel, variable							
0.5 – 10 µL	medium gray	0.5 µL	±10.0 %	±0.05 µL	±6.0 %	±0.03 µL	4861 000 767
		1 µL	±5.0 %	±0.05 µL	±3.0 %	±0.03 µL	
		5 µL	±3.0 %	±0.15 µL	±1.5 %	±0.075 µL	
		10 µL	±2.0 %	±0.2 µL	±0.8 %	±0.08 µL	
5 – 100 µL	yellow	5 µL	±6.0 %	±0.3 µL	±4.0 %	±0.2 µL	4861 000 783
		10 µL	±2.0 %	±0.2 µL	±2.0 %	±0.2 µL	
		50 µL	±1.0 %	±0.5 µL	±0.8 %	±0.4 µL	
		100 µL	±0.8 %	±0.8 µL	±0.25 %	±0.25 µL	
15 – 300 µL	orange	15 µL	±6.0 %	±0.9 µL	±2.0 %	±0.3 µL	4861 000 805
		30 µL	±2.5 %	±0.75 µL	±1.0 %	±0.3 µL	
		150 µL	±1.0 %	±1.5 µL	±0.5 %	±0.75 µL	
		300 µL	±0.6 %	±1.8 µL	±0.25 %	±0.75 µL	
50 – 1,200 µL	green	50 µL	±8.0 %	±4.0 µL	±1.2 %	±0.6 µL	4861 000 821
		120 µL	±6.0 %	±7.2 µL	±0.9 %	±1.08 µL	
		600 µL	±2.7 %	±16.2 µL	±0.4 %	±2.4 µL	
		1,200 µL	±1.2 %	±14.4 µL	±0.3 %	±3.6 µL	

¹⁾ The error data, according to EN ISO 8655, only apply if original Eppendorf tips are used. Technical specifications are subject to change. Errors and omissions excepted.

For 8-channel pipettes please choose standard epT.I.P.S., see pages 58 - 65

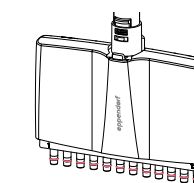

12-channel pipettes

Ordering information

Volume range	Color code	Volume	Rel. systematic error ¹⁾	Abs. systematic error ¹⁾	Rel. random error ¹⁾	Abs. random error ¹⁾	Order no.
Eppendorf Xplorer® plus, 12-channel, variable							
0.5 – 10 µL	medium gray	0.5 µL	±10.0 %	±0.05 µL	±6.0 %	±0.03 µL	4861 000 775
		1 µL	±5.0 %	±0.05 µL	±3.0 %	±0.03 µL	
		5 µL	±3.0 %	±0.15 µL	±1.5 %	±0.075 µL	
		10 µL	±2.0 %	±0.2 µL	±0.8 %	±0.08 µL	
5 – 100 µL	yellow	5 µL	±6.0 %	±0.3 µL	±4.0 %	±0.2 µL	4861 000 791
		10 µL	±2.0 %	±0.2 µL	±2.0 %	±0.2 µL	
		50 µL	±1.0 %	±0.5 µL	±0.8 %	±0.4 µL	
		100 µL	±0.8 %	±0.8 µL	±0.25 %	±0.25 µL	
15 – 300 µL	orange	15 µL	±6.0 %	±0.9 µL	±2.0 %	±0.3 µL	4861 000 813
		30 µL	±2.5 %	±0.75 µL	±1.0 %	±0.3 µL	
		150 µL	±1.0 %	±1.5 µL	±0.5 %	±0.75 µL	
		300 µL	±0.6 %	±1.8 µL	±0.25 %	±0.75 µL	
50 – 1,200 µL	green	50 µL	±8.0 %	±4.0 µL	±1.2 %	±0.6 µL	4861 000 830
		120 µL	±6.0 %	±7.2 µL	±0.9 %	±1.08 µL	
		600 µL	±2.7 %	±16.2 µL	±0.4 %	±2.4 µL	
		1,200 µL	±1.2 %	±14.4 µL	±0.3 %	±3.6 µL	

¹⁾ The error data, according to EN ISO 8655, only apply if original Eppendorf tips are used. Technical specifications are subject to change. Errors and omissions excepted.

For 12-channel pipettes please choose standard epT.I.P.S., see pages 58 - 65

Eppendorf Xplorer® plus

16-channel pipettes, for 384-well plates

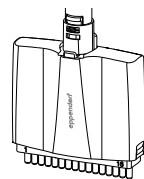

Ordering information

Volume range	Color code	Volume	Rel. systematic error ¹⁾	Abs. systematic error ¹⁾	Rel. random error ¹⁾	Abs. random error ¹⁾	Order no.
Eppendorf Xplorer® plus, 16-channel, variable							
1 – 20 µL	■ light pink	1 µL	±12 %	±0.12 µL	±8 %	±0.08 µL	4861 000 778
		2 µL	±8 %	±0.16 µL	±5 %	±0.1 µL	
		10 µL	±4 %	±0.4 µL	±2 %	±0.2 µL	
		20 µL	±2 %	±0.4 µL	±1 %	±0.2 µL	
5 – 100 µL	■ light yellow	5 µL	±6 %	±0.3 µL	±4 %	±0.2 µL	4861 000 792
		10 µL	±3 %	±0.3 µL	±2 %	±0.2 µL	
		50 µL	±1.2 %	±0.6 µL	±0.8 %	±0.4 µL	
		100 µL	±1 %	±1 µL	±0.6 %	±0.6 µL	

¹⁾ The error data, according to EN ISO 8655, only apply if original Eppendorf tips are used. Technical specifications are subject to change. Errors and omissions excepted.

For 16-channel pipettes please choose epT.I.P.S. 384, see pages 64 - 65

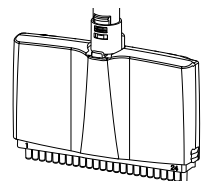

24-channel pipettes, for 384-well plates

Ordering information

Volume range	Color code	Volume	Rel. systematic error ¹⁾	Abs. systematic error ¹⁾	Rel. random error ¹⁾	Abs. random error ¹⁾	Order no.
Eppendorf Xplorer® plus, 24-channel, variable							
1 – 20 µL	■ light pink	1 µL	±12 %	±0.12 µL	±8 %	±0.08 µL	4861 000 779
		2 µL	±8 %	±0.16 µL	±5 %	±0.1 µL	
		10 µL	±4 %	±0.4 µL	±2 %	±0.2 µL	
		20 µL	±2 %	±0.4 µL	±1 %	±0.2 µL	
5 – 100 µL	■ light yellow	5 µL	±6 %	±0.3 µL	±4 %	±0.2 µL	4861 000 793
		10 µL	±3 %	±0.3 µL	±2 %	±0.2 µL	
		50 µL	±1.2 %	±0.6 µL	±0.8 %	±0.4 µL	
		100 µL	±1 %	±1 µL	±0.6 %	±0.6 µL	

¹⁾ The error data, according to EN ISO 8655, only apply if original Eppendorf tips are used. Technical specifications are subject to change. Errors and omissions excepted.

For 24-channel pipettes please choose epT.I.P.S. 384 see pages 64 - 65

Accessories

Description	Order no.
Power supply with power plug adapters, for pipettes and charger stand	4986 603 005
Power supply with power plug adapters, for charger carousel (4880)	4880 603 006
Multi-channel tool, for cutting the O-rings on the tip cone of multi-channel lower parts, 5 – 100 µL or 15 – 300 µL	3122 610 003
Pipette wrench 2 mL – 10 mL	3120 634 002
Key, for detachment of 1,200 µL pipettes lower parts	4861 605 006
Locking ring, to prevent spring action with single-channel pipettes, 2.5 µL – 1,000 µL	3120 635 009
Locking clip for 8 channel pipette, to prevent spring action of tip cones, 2 pieces	3122 612 006
Locking clip for 12 channel pipette, to prevent spring action of tip cones, 3 pieces	3122 613 002
Reagent reservoir Tip-Tub, autoclavable reservoir for the aspiration of liquids with multi-channel pipettes, 1 set = 10 reservoirs and 10 lids	0030 058 607
Pipette grease with lint-free applicator	0013 022 153
Eppendorf TrackIT, RFID Reader and Software	3903 000 014

Technical specifications subject to change.

Move It® - Adjustable Multichannel Pipettes

Eppendorf Research® plus and Eppendorf Xplorer® plus

Double your performance

Often, single channel pipettes are used for multiple sample transfer from one vessel type to another, from tubes to plates for instance. This can be time-consuming and inconvenient, especially when throughput increases. Instead of pipetting many times, up to twelve samples can now be moved simultaneously with the new 4, 6, 8 and 12-channel pipettes Eppendorf Research® plus and Eppendorf Xplorer® plus Move It®. Move It pipettes have adjustable cones for variable tip spacings according to your vessel format. This easy handling of format changes helps to reduce throughput time by 50 % and increases reproducibility of your results.

New



Product features

- > 4, 6, 8 and 12-channel air-cushion pipettes with adjustable cone spacing
- > Available in mechanical (Research plus) and electronic (Xplorer plus) versions
- > For plates (384, 96, 48, 24 and 12-wells), tubes (1.5 and 2.0 mL), and agarose gels
- > Tip spacing selectable from 4.5 to 33 mm
- > Adjustment knob for smooth and vibration-free format switches and liquid transfers without dripping
- > Spacing limiter for quick switches backwards and forwards between source and destination formats
- > Tubeless system for higher precision, reproducibility, and robustness
- > Autoclavable for easy decontamination
- > Rotatable pipette head 360° for comfortable readability of display and fast identification of parameters
- > Optimally balanced for reduced hand fatigue

Applications

- > Blood analysis
- > FACS analysis
- > Cell Based Assays
- > Cell Culture
- > ELISA
- > PCR
- > Mouse genotyping

Multiple sample transfer between different formats becomes fast and secure with Move It

Instead of pipetting many times, move 4 – 12 samples simultaneously. Reduce throughput time while increasing your performance.

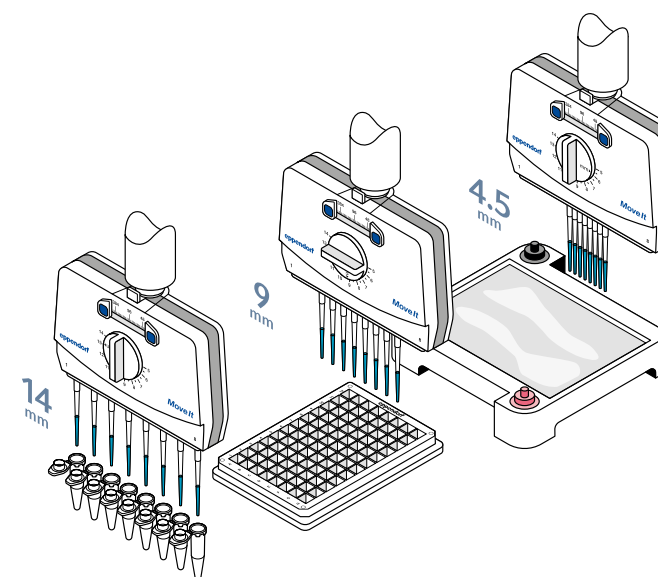

Your local distributor: www.eppendorf.com/contact

Eppendorf AG · Barkhausenweg 1 · 22339 Hamburg · Germany · eppendorf@eppendorf.com · www.eppendorf.com · www.eppendorf.com/eshop

Move It® - Adjustable Multichannel Pipettes

Eppendorf Research® plus and Eppendorf Xplorer® plus

Move It selection guide

Find the right choice for your application. Select the source and destination formats according to your application and see which version suits your application best.

New

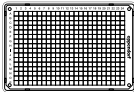
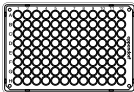
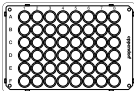
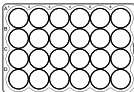
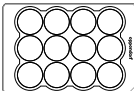
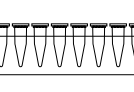
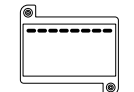

Vessel Type	Type of tips	epT.I.P.S.®			epT.I.P.S.® 384	
	Electronic/Manual	Xplorer plus/Research plus			Xplorer plus/Research plus	
	Number of channels	4	6	8	8	12
	Volume	300 µL/1,200 µL	300 µL/1,200 µL	300 µL/1,200 µL	20 µL/100 µL	20 µL/100 µL
	Adj. Cone Spacing (mm)	9-33 mm	9-20 mm	9-14 mm	4.5-14 mm	4.5-9 mm
	384 Wells (Tip distance 4.5 mm)	-	-	-	■	■
	96 Wells (Tip distance 9 mm)	■	■	■	■	■
	48 Wells (Tip distance 13 mm)	■	■	■	■	-
	24 Wells (Tip distance 19 mm)	■	■	-	-	-
	12 Wells (Tip distance 26 mm)	■	-	-	-	-
	1.5/2.0 mL Tube (Tip distance 14, 18, 20 mm)	■ ¹⁾	■ ¹⁾	■ ²⁾	■ ²⁾	-
	Agarose gel	-	-	-	■	■

¹⁾ 14, 18, 20 mm ²⁾ 14 mm



You have the choice

Mechanical Research plus pipettes are the workhorses for each lab. The Xplorer electronic pipettes with highest variety of functions are the ideal instrument if you need intuitively and precisely adjustable parameters, reproducible and accurate results while experiencing fatigue-free pipetting.

Move It®, mechanical multichannel pipettes, adjustable cone distance

Ordering information				
Description	Number of channels	Volume range	Color code	Order no.
Eppendorf Research® plus Move It®	4-channel	15 – 300 µL	orange	3125 000 150
		120 – 1,200 µL	dark green	3125 000 184
	6-channel	15 – 300 µL	orange	3125 000 168
		120 – 1,200 µL	dark green	3125 000 192
	8-channel	1 – 20 µL	light pink	3125 000 117
		5 – 100 µL	light yellow	3125 000 133
		15 – 300 µL	orange	3125 000 176
		120 – 1,200 µL	dark green	3125 000 206
	12-channel	1 – 20 µL	light pink	3125 000 125
		5 – 100 µL	light yellow	3125 000 141

Move It®, electronic multichannel pipettes, adjustable cone distance

Ordering information				
Description	Number of channels	Volume range	Color code	Order no.
Eppendorf Xplorer® plus Move It®	4-channel	15 – 300 µL	orange	4861 000 816
		50 – 1,200 µL	green	4861 000 833
	6-channel	15 – 300 µL	orange	4861 000 817
		50 – 1,200 µL	green	4861 000 834
	8-channel	1 – 20 µL	light pink	4861 000 781
		5 – 100 µL	light yellow	4861 000 794
		15 – 300 µL	orange	4861 000 818
		50 – 1,200 µL	green	4861 000 835
	12-channel	1 – 20 µL	light pink	4861 000 782
		5 – 100 µL	light yellow	4861 000 795

Eppendorf Pipette Holder System

Description

Carousels, stands and wall mount devices: The new Pipette Holder System is perfect for all users of handheld liquid handling instruments, who need a highly flexible system for their Eppendorf pipettes and Multipipette®. Carousels and stands provide a robust design with a small footprint. To save precious bench-top space carousels carry both manual and electronic instruments. And only Eppendorf offers a charger carousel with intelligent charging electronics that carries up to 6 instruments.



1. The Pipette Carousel 2 for manual pipettes and the Charger Carousel 2 for electronic devices offer more flexibility and more capacity than ever before.
 - > Rotatable pipette holders carry all current manual Eppendorf pipettes and most predecessors
 - > Charger Carousel 2 for up to six electronic devices with magnetic power connector for fast and easy connection



2. With Charger Stand 2, the Eppendorf Xplorer/Xplorer plus or Multipipette® E3/E3x is always fully charged and ready for use. Pipette Stand 2 carries one Multipipette M4.
 - > Large rubber feet protect stands and carousels from liquids spilled on lab bench
 - > Charger Stand 2 with cord wrap functionality for more convenience



3. Place your pipette and Multipipette where you need them: Mounted to a wall, on the shelf above your bench or inside a biological safety cabinet.
 - > Pictograms on all holders for clear assignment in the lab
 - > Pipette holders are downwards compatible for Eppendorf Research and Reference pipettes

Ordering information

Description	Order no.
Pipette Carousel 2 , for 6 Eppendorf Research®, Eppendorf Research® plus, Eppendorf Reference®, Eppendorf Reference® 2 or Biomaster®, additional pipette holders are optionally available	3116 000 015
Charger Carousel 2 , for 6 Eppendorf Xplorer® or Eppendorf Xplorer® plus, mains/power adapter included, additional charger shells and pipette holders are optionally available	3116 000 023
Charger Stand 2 , for one Eppendorf Xplorer® or Eppendorf Xplorer® plus, operated with mains/power adapter supplied with Eppendorf Xplorer® or Eppendorf Xplorer® plus	3116 000 031
Charger Stand 2 , for one Multipipette® E3/E3x or Multipipette® stream/Xstream, operated with mains/power adapter supplied with Multipipette® E3/E3x or Multipipette® stream/Xstream	3116 000 040
Pipette Stand 2 , for one Multipipette® M4, without charging functionality, additional pipette holders are optionally available	3116 000 058
Pipette Holder 2 , for one Eppendorf Research®, Eppendorf Research® plus, Eppendorf Reference® 2 or Biomaster®, for Pipette Carousel 2 and Charger Carousel 2 or wall mounting, sticky tape included	3116 000 112
Pipette Holder 2 , for one Eppendorf Xplorer® or Eppendorf Xplorer® plus, for Pipette Carousel 2 or wall mounting, sticky tape included, without charging functionality	3116 000 120
Pipette Holder 2 , for one Multipipette® E3/E3x or Multipipette® stream/Xstream, for Pipette Carousel 2 or wall mounting, sticky tape included, without charging functionality	3116 000 139
Pipette Holder 2 , for one Multipipette® M4, for Pipette Carousel 2 and Charger Carousel 2 or wall mounting, sticky tape included	3116 000 147
Charger Shell 2 , for one Eppendorf Xplorer® or Eppendorf Xplorer® plus, for Charger Carousel 2 (with charging functionality)	3116 602 007
Charger Shell 2 , for one Multipipette® E3/E3x or Multipipette® stream/Xstream, for Charger Carousel 2 (with charging functionality)	3116 603 003

Eppendorf Purity Grades for Tips

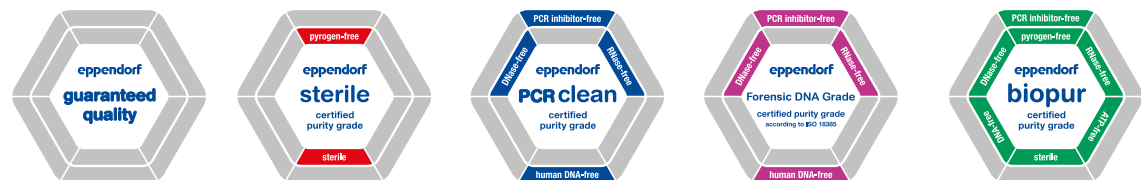

epT.I.P.S.[®], ep Dualfilter T.I.P.S.[®] and Combitips advanced[®] stand for highest quality and purity

The high precision and accuracy of pipette tips and Combitips[®] is ensured by precise molding. Each lot of pipette tips and Combitips is subject to gravimetric measurement during final testing. Low wetting ensures reliable volume readings and minimal adhesion.

Pipette tips and Combitips cylinders are made of PP (polypropylene). A relatively inert plastic characterized by low wettability as well as high dimensional and mechanical stability across a wide temperature range. For the Combitips advanced pistons, PE (polyethylene) is used. This is due to the fact that ideal running properties between two parts can only be achieved by using two different types of plastic. Our tips are available in a variety of purity grades (see table opposite). For further details please read page 12 - 13.

Pure quality

With the strictest control criteria, internally and externally monitored, we ensure the consistently high quality of our products – from lot to lot. Our consumables are available in a variety of purity qualities. Eppendorf Quality[™] as well as more advanced purity grades: “Sterile, Protein-free, PCR clean, Eppendorf Forensic DNA Grade, and Biopur[®]”. In addition to our internal process controls and general quality certificates, lot-specific certificates are provided by an external accredited laboratory for the Sterile, Protein-free, PCR clean, Eppendorf Forensic DNA Grade, and Biopur purity grades. This allows us to consistently meet our customer’s high demands when it comes to purity (www.eppendorf.com/purity). As a special service, we make the inspection certificate for each delivered lot available online (www.eppendorf.com/certificates).

Purity grades

Eppendorf purity grades for tips	Eppendorf Quality [™]	Eppendorf sterile	Eppendorf PCR clean	Eppendorf sterile and PCR clean	Eppendorf Forensic DNA Grade ⁽¹⁾	Biopur [®]
Continuous quality control for the following relevant criteria:						
Function, tightness, precision	■	■	■	■	■	■
Low wetting	■	■	■	■	■	■
High chemical resistance	■	■	■	■	■	■
High thermal resistance	■	■	■	■	■	■
High resistance to centrifugation forces ⁽¹⁾	■	■	■	■	■	■
High transparency	■	■	■	■	■	■
Precisely shaped	■	■	■	■	■	■
Lot-specific certified⁽²⁾ for the following purity criteria:						
Pyrogen-free ⁽⁵⁾ (endotoxin-free)		■		■		■
Sterile (Ph.Eur./USP)		■		■		■
DNA-free ⁽⁵⁾ (Human DNA)			■	■	■	■
DNA-free ⁽⁵⁾ (Bacteria DNA)			■	■	■	■
DNase-free ⁽⁵⁾			■	■	■	■
RNase-free ⁽⁵⁾			■	■	■	■
PCR-inhibitor-free ⁽⁵⁾			■	■	■	■
ATP-free ⁽⁵⁾						■
Eppendorf tips						
epT.I.P.S. [®] Standard, Box and Set	■					
epT.I.P.S. [®] Reloads	■		■			
epT.I.P.S. [®] Racks				■ ⁽³⁾		■
epT.I.P.S. [®] Singles						■
ep Dualfilter T.I.P.S. [®]				■	■	
ep Dualfilter T.I.P.S. [®] SealMax				■		
ep Dualfilter T.I.P.S. [®] LoRetention				■		
Combitips advanced [®]	■		■	■ ⁽³⁾	■	■
ViscoTip [®]	■					
epT.I.P.S. [®] LoRetention	■		■			
epT.I.P.S. [®] Motion	■					
epT.I.P.S. [®] Motion filtertips	■					■

⁽¹⁾ For accurate details regarding resistance to centrifugation, please refer to the respective product pages. ⁽²⁾ Lot-specific certificate can be downloaded from www.eppendorf.com/certificates. ⁽³⁾ Only available in North America. ⁽⁴⁾ According to ISO 18385. ⁽⁵⁾ Testing showed conformity within the detection limits



www.eppendorf.com/puritygrades-brochure

epT.I.P.S.[®]

Description

For epT.I.P.S. – the original Eppendorf „Totally Integrated Pipetting System“ – the tips are optimally coordinated to Eppendorf pipettes and, of course, meet EN ISO 8655 requirements. This has resulted in minimal attachment and ejection forces with the highest level of tightness. epT.I.P.S. pipette tips can be used with pipettes from other manufacturers. Optimal wetting properties, high transparency and special, certified purity grades are the visible expression of our product and production philosophy.



Product features

- > The ergonomically optimized cone geometry provides the optimal pipette fit on the Eppendorf pipette
- > epT.I.P.S. pipette tips can be used universally, including pipette models from other manufacturers
- > Fine graduations make visual checks of the pipetting volume even easier
- > Long, narrow tips reach the base of narrow and high vessels without touching the top of the vessel edge
- > Fine retracted or extended tips simplify work with small volumes
- > Available in purity grades of: Eppendorf Quality, PCR clean, Biopur[®]
- > Color-coded trays make volume identification and allocation of Eppendorf pipettes easier than ever
- > Also available for 16- and 24-channel pipettes

Applications

- > Pipetting liquids
- > Dispensing liquids
- > Mixing liquids
- > Filling plates and reaction vessels
- > Filling gels for electrophoresis
- > Phase extraction and removal of supernatants
- > For applications in 384-microplate format we recommend using 16- or 24-channel pipettes together with epT.I.P.S. 384

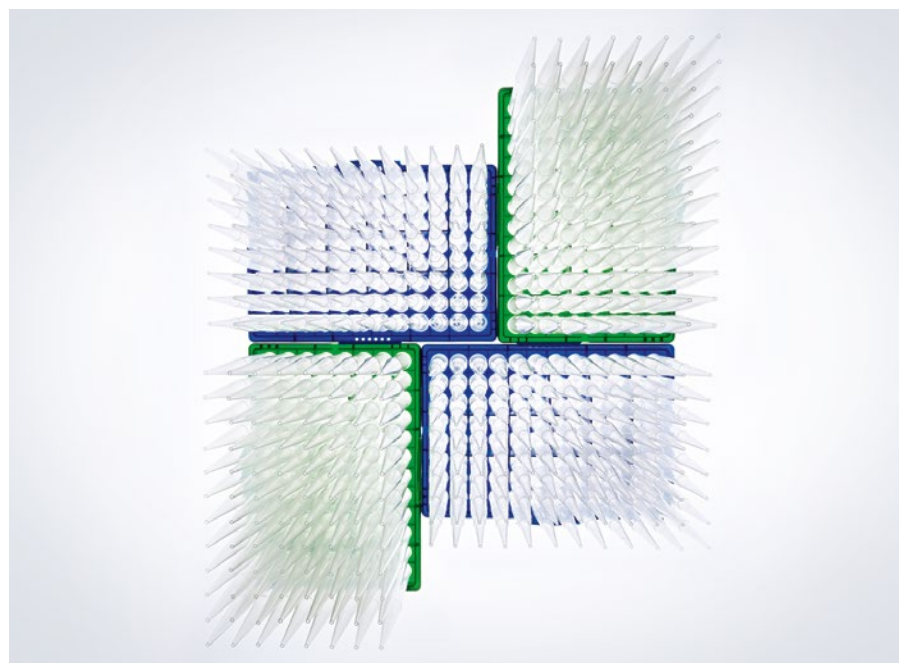

www.eppendorf.com/appnote354

For more information go to www.eppendorf.com/epTips



epT.I.P.S.[®] Standard

- > Original, high-quality Eppendorf pipette tips packaged in resealable bags
- > Available in sizes from 10 µL to 10 mL in Eppendorf Quality purity grade
- > epT.I.P.S. Standard 200 µL, 300 µL and 1,000 µL tips are also available color-coded yellow and blue
- > epT.I.P.S. Standard pipette tips can be autoclaved at 121 °C in 20 min.



epT.I.P.S.[®] Box/epT.I.P.S.[®] Set

- > Contamination-free transfer of trays to stable working box
- > System optimized for use with multi-channel pipettes
- > Color-coded trays for simple identification of tips and pipette
- > Tips can be attached to pipette from refill trays
- > Boxes and trays are autoclavable
- > epT.I.P.S. Box and epT.I.P.S. Set available in Eppendorf Quality

New



epT.I.P.S.[®] Racks

- > Eppendorf Biopur pipette tips in disposable Racks offer the highest biological purity grade
- > Ensured PCR clean, sterile, pyrogen-, ATP- and DNA-free
- > All pre-sterilized epT.I.P.S. and ep Dualfilter T.I.P.S. variants are available in Racks
- > Sterility packaging is compliant to standards DIN EN ISO 11607 and DIN EN 868-2-10
- > Each production lot of Racks inspected continuously by an independent laboratory
- > Lot-specific certificates available at www.eppendorf.com/certificates
- > Packed in Racks with 384, 96, 48 or 24 tips
- > For use in pharmaceutical and food industry, molecular biology and cell technology



epT.I.P.S.[®] Singles

- > Eppendorf Biopur pipette tip, individually wrapped
- > Ensured PCR clean, sterile, pyrogen-, ATP- and DNA-free
- > For use in pharmaceutical and food industry, molecular biology and cell technology
- > Batch number and expiration date on each blister package
- > Each production lot inspected continuously by an independent laboratory
- > Lot-specific certificates available at www.eppendorf.com/certificates

epT.I.P.S.[®]**epT.I.P.S.[®] Reloads**

- > Reduced waste as compared with disposable racks
- > The refill trays can be autoclaved up to 121 °C, in packaging and without foil, for subsequent use
- > The refill system, depending on tip size, is packaged as either dual-sided or in stack form
- > Available in purity grades of Eppendorf Quality and PCR clean
- > Color-coded trays for simple volume and pipette identification

Special Tips

**GELoader[®]**

- > Special tip for gel electrophoresis, loading of polyacrylamide gels
- > Flexible long and narrow tips for handling of smallest volumes
- > GELoader tips and rack autoclavable
- > Highest precision and accuracy when used with Eppendorf pipettes for 0.5 to 10 µL (gray control button)

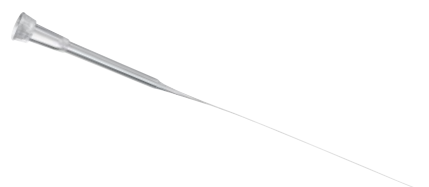
**Microloader[™]**

- > Extremely long, fine and flexible tip for filling of microcapillaries for microinjection and where additional reach is needed
- > Microloader tips and rack autoclavable
- > Highest precision and accuracy when used with Eppendorf pipettes for 0.5 to 10 µL (gray control button)

► Ordering information see page 63

Technical specifications subject to change.

epT.I.P.S.[®] 384**epT.I.P.S. 384 with SOFTattach technology for 16 and 24-channel pipettes**

For the first time, micropipette tips have elastic forming grooves. They allow the tips to stretch as much as necessary to enable a perfect seal while operating forces are reduced to a minimum. Your benefits of using this perfectly coordinated system of pipette and tip are outstanding and reliable tip fit and tightness combined with reduced tip attachment and ejection forces. It couldn't be easier to perfectly hit all 384 wells as the new micropipette tips have an extremely fine tip shape, and an extraordinary coaxiality which enables a perfect tip alignment.

**Product features**

- > Designed for a cone distance of 4.5 mm
- > epT.I.P.S. 384 pipette tips build a system together with the Research plus and Xplorer plus 16 and 24-channel pipettes for utmost safety and reliability
- > Innovative SOFTattach technology allows for reliable tip fit and tightness
- > Fill a whole 384-well plate without loosening pipette tips
- > Perfect tip alignment by extraordinary coaxiality for safe plate maneuvering and liquid transfer
- > The tip shape of the epT.I.P.S. 384 is adjusted to perfectly fit the wells of 384-well plates
- > Tip attachment forces reduced by 40 % per cone compared to 8 and 12-channel pipettes
- > Tip ejection forces reduced by SOFTattach for ergonomic working conditions
- > Available as reload, and set
- > Available in purity grades: Eppendorf Quality and PCR clean

**Applications**

- > Biochemical assays
- > Cell based assays
- > Immunoassays
- > Storage of biological samples or chemical compounds
- > Nucleic acid based methods
 - > Amplification
 - > Loading of agarose gels
 - > Purification
 - > Quantification
 - > Sequencing

The elastic forming grooves

as soon as the tips are attached, they adapt perfectly to the shape of the tip cone. This SOFTattach technology allows the user to achieve perfect tip tightness and safety.

epT.I.P.S.[®] Long

Description

With the slim design of the extra long epT.I.P.S. and ep Dualfilter T.I.P.S.[®] pipette tips, you always achieve best results when pipetting into Eppendorf Tubes[®] 5.0 mL, conical tubes, cell culture flasks, deep wells and other deep vessels. Furthermore, the risk of touching the walls of these deep vessels is minimized and cross-contamination is prevented. Extra long epT.I.P.S. are available in the following volumes:

- > 0.5 – 20 µL L (46 mm)
- > 50 – 1,250 µL L (103 mm)
- > 0.2 – 5 mL L (175 mm)
- > 0.5 – 10 mL L (243 mm)



Product features

- > Slim design of the extra long epT.I.P.S. and ep Dualfilter T.I.P.S. pipette tips
- > Always obtain high-quality results when pipetting from and into Eppendorf Tubes[®] 5.0 mL, conical tubes, cell culture flasks, deep wells and other deep vessels
- > The risk of touching the walls of deep vessels is minimized and cross-contamination is prevented
- > Available in Eppendorf Quality, PCR clean, PCR clean/Sterile (sterile and pyrogen-free), and Biopur[®] purity grades
- > Also available as ep Dualfilter T.I.P.S. filter tips

Applications

- > Pipetting liquids
- > Dispensing liquids
- > Mixing liquids
- > Filling plates and reaction vessels
- > Filling gels for electrophoresis
- > Phase extraction and removal of supernatants



www.eppendorf.com/eptips-video

For more information go to www.eppendorf.com/epTips

Technical specifications subject to change.

ep Dualfilter T.I.P.S.[®]

Description

ep Dualfilter T.I.P.S. filter tips are filter tips with a two-phase filter for contamination protection. The two filter layers made of flexible, hydrophobic material, fit perfectly in the tip cone and retain practically 100 % of all aerosols¹⁾ and biomolecules. This filtering effect is achieved using various, well-defined pore sizes. The layer facing the sample provides protection from drops, splashes and aerosols. The layer facing the pipette cone functions as a second barrier from contamination, and dependably binds biomolecules. A defined air passage rate ensures full sample recovery and the customary quick pipetting.



Product features

- > Dual protection against aerosols¹⁾ and biomolecules
- > Dual protection for pipette and sample
- > Free of PCR inhibitor additives
- > Available in Eppendorf PCR clean/Sterile (sterile and pyrogen-free) and Eppendorf Forensic DNA Grade
- > Tested at the Fraunhofer Institute for Toxicology and Experimental Medicine (ITEM) in Hannover, Germany
- > Continuous inspection of each production lot by an independent laboratory
- > Lot-specific certificates are available at: [certificates homepage](#).
- > Certificate of filter efficiency acc. to EN 1822 available at: [certificates homepage](#)
- > Also available for 16- and 24-channel pipettes

Applications

- > DNA applications (e.g. PCR)
- > RNA applications (e.g. gene expression analysis)
- > Protein applications (e.g. antibody research)
- > Cell culture applications (e.g. media)
- > Applications with radio actives
- > All applications which use aerosol¹⁾ binding liquids
- > For applications in 384-microplate format we recommend using 16- or 24-channel pipettes together with epT.I.P.S.[®] 384

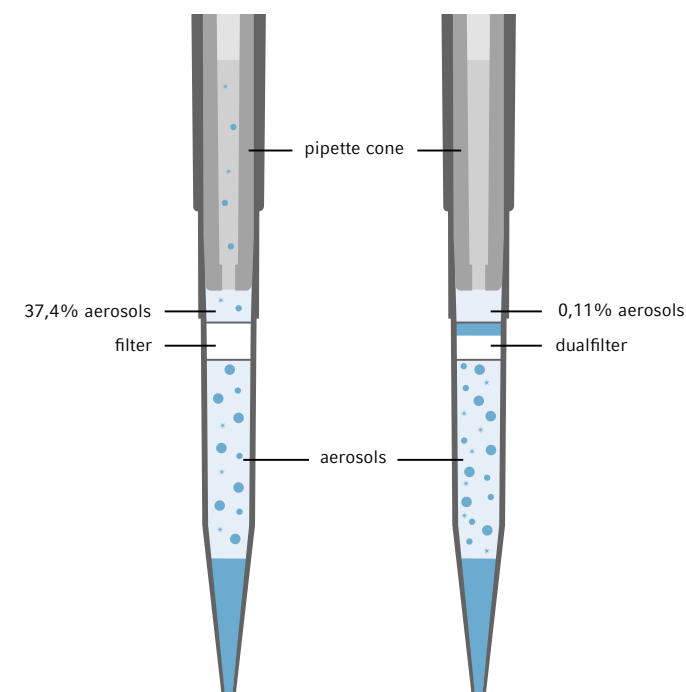

Competitor filtertip

ep Dualfilter T.I.P.S.[®]

The unmistakable blue and white filter layers are made of flexible, hydrophobic material to fit perfectly in the tip cone and retain practically 100 % of all aerosols¹⁾ and biomolecules. This unique filtering effect is achieved using various well-defined pore sizes in the two filter layers.

¹⁾ An aerosol is a colloid of fine solid particles or liquid droplets in air or another gas.

ep Dualfilter T.I.P.S.[®] 384

ep Dualfilter T.I.P.S. 384 with SOFTattach technology for 16- and 24-channel pipettes

For the first time, filter pipette tips have elastic forming grooves. They allow the filter tips to stretch as much as necessary to enable a perfect seal while operating forces are reduced to a minimum. Your benefits of using this perfectly coordinated system of pipette and tip are outstanding and reliable tip fit and tightness combined with reduced pipette tip attachment and ejection forces. It couldn't be easier to perfectly hit all 384 wells as the new filter tips have an extremely fine tip shape, and an extraordinary coaxiality which enables a perfect tip alignment.

New

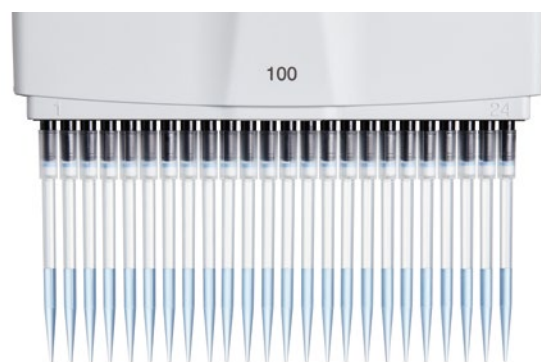
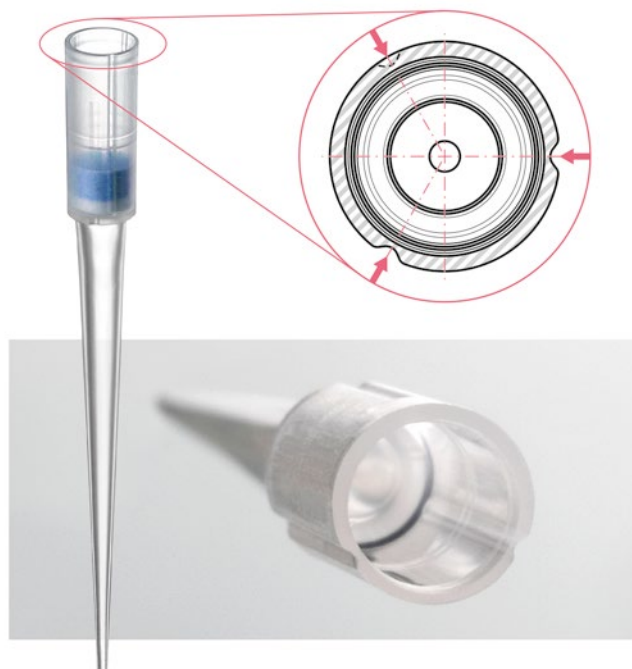

Product features

- > ep Dualfilter T.I.P.S. 384 pipette tips build a system together with Research plus and Xplorer plus 16 and 24-channel pipettes for utmost safety and reliability
- > Innovative SOFTattach technology allows for reliable tip fit and tightness while operating forces are reduced to a minimum
- > Fill a whole 384-well plate without loosening pipette tips
- > A perfect tip alignment is guaranteed by extraordinary coaxiality for safe plate maneuvering and liquid transfer
- > The tip shape of ep Dualfilter T.I.P.S. 384 is adjusted to perfectly fit the wells of 384-well plates
- > Dual protection for pipette and sample against aerosols¹⁾ and biomolecules
- > Lot-specific certificates are available at: certificates homepage.
- > Certificate of filter efficiency acc. to EN 1822 available at: certificates homepage
- > Available as racks
- > Available in purity grades of: PCR clean and sterile

Applications

- > DNA applications (e.g. PCR)
- > RNA applications (e.g. gene expression analysis)
- > Protein applications (e.g. antibody research)
- > Cell culture applications (e.g. media)
- > Applications with radioactives
- > All applications which use aerosol¹⁾ binding liquids

¹⁾ An aerosol is a colloid of fine solid particles or liquid droplets in air or another gas.

An extraordinary tip alignment

all tips are perfectly aligned, making it easy and safe to transfer up to 24 samples simultaneously to the 384-well plate.

ep Dualfilter T.I.P.S.[®] SealMax

Description

The violet and white filter for the ep Dualfilter T.I.P.S.[®] SealMax filter tips combine a reliable contamination protection for your pipette from your sample liquid with virtually 100 % protection from aerosols¹⁾ and biomolecules. This Dualfilter closes immediately when it comes into contact with the overpipetted sample without inhibiting valuable material. Additionally drops and splashes are retained by the white layer, the violet layer forms the highly-effective barrier against sample liquid. Further information and certification on specific sample recovery features, PCR inhibition and aerosol protection are available on your local Eppendorf website.



Product features

- > Reliable protection from liquids
- > Reliable protection from aerosols¹⁾ and biomolecules
- > No PCR inhibiting additives
- > Protection of your pipette from aggressive liquids when over-aspiration occurs
- > Available in PCR clean/Sterile (sterile and pyrogen-free)
- > Continuous inspection of each production lot by an independent laboratory ensures high purity and quality
- > Lot specific purity certificates available at: www.eppendorf.com/certificates
- > Certificate of filter efficiency acc. to EN 1822 available at: www.eppendorf.com/certificates

Applications

- > DNA applications (e.g. PCR)
- > RNA applications (e.g. gene expression analysis)
- > Protein applications (e.g. antibody research)
- > Cell culture applications (e.g. media)
- > Applications with radio actives
- > All applications which use aerosol¹⁾ binding liquids

¹⁾ An aerosol is a colloid of fine solid particles or liquid droplets in air or another gas.

For more information go to www.eppendorf.com/epTips

epT.I.P.S.[®] LoRetention

Description

epT.I.P.S. LoRetention pipette tips and ep Dualfilter T.I.P.S. LoRetention filter tips are particularly well-suited for applications with samples that contain detergents. Detergents or detergent containing liquids lower the liquid's surface tension. This leads to a phenomenon called "wetting": Residual liquid sticks to the tip wall and cannot be recovered. The invisible film left behind in standard tips shows a significantly high amount of valuable sample material which becomes discarded together with the tip. Particularly when it comes to sensitive PCR and *real-time* PCR applications or NGS library preparation, low retention surfaces can increase the reproducibility and significantly reduce the loss of expensive reagents. The low retention property of epT.I.P.S. LoRetention pipette tips and ep Dualfilter T.I.P.S. LoRetention filter tips is generated by an ultrahydrophobic, extremely homogeneous surface. It is achieved through an innovative treatment at the molecular level – the "Pearl Effect" Technology. All pipette tips are uncoated, free of additives and do not leach into the sample. Liquids containing detergents simply roll off, so that practically no liquid remains in the tip. These outstanding material properties ensure maximized sample recovery for cost saving and improved reproducibility.



Product features

- > Ultrahomogenous surface for maximized reproducibility
- > Ultrahydrophobic surface for minimal sample loss
- > Significantly reduced foam formation during pipetting
- > Extreme resistance to chemicals
- > Available in PCR clean and Eppendorf Quality
- > Also available as ep Dualfilter T.I.P.S. in PCR clean/Sterile (sterile and pyrogen-free)
- > No coating
- > Lot-specific certificates are available at: www.eppendorf.com/certificates

The "Pearl Effect" – a comparison of the amount of residual liquid when pipetting solutions that contain detergents:

1. Significant loss of sample using standard tips
2. Maximized recovery with epT.I.P.S. LoRetention

Applications

- > Cell culture (media)
- > Genomics: PCR, RT-PCR, qPCR and all other types of PCR
- > Enzymatic reactions (restriction decomposition, ligation)
- > Isolation and purification of nucleic acid
- > Gel electrophoresis (e.g., prefabricated DNA ladders) typical detergents: SDS, Triton[®], X-100, Brij[®] 35, Tween[®] 20, CHAPS
- > Proteomics (all types of protein examinations)
- > Protein isolation and purification
- > NGS library preparation

➤ Ordering information see page 58

Maximized reproducibility in genomics

epT.I.P.S. LoRetention are especially recommended for applications where highest precision of DNA/RNA analysis results are needed, such as for PCR and *real-time* PCR. For example, expensive master mixes and enzyme solutions tend to adhere to the tip's inner surface. Specially treated low retention surfaces are created to repel detergent solutions to a maximum – for minimum loss of your valuable sample.

Examples for liquids with wetting effect:

- > Master mixes
- > Enzyme solutions: enzyme restrictions, ligation, DNase
- > DNA ladders for gel electrophoresis

epT.I.P.S. LoRetention perform considerably better in terms of precision and sample recovery than standard pipette tips as shown in **Fig. 1**.

Maximized reproducibility in proteomics

Not only in molecular biology, high sensitivity detection methods require extreme reliability and reproducibility in pipetting. Also in protein analysis and purification, the reagents and samples often contain detergents, like e.g. SDS-Page. By minimizing sample retention and improving reproducibility of pipetting, epT.I.P.S. LoRetention pipette tips and ep Dualfilter T.I.P.S. LoRetention filter tips are especially advantageous in proteomic applications.

Routine protein applications:

- > Isolation
- > Purification
- > Denaturation

The facts are self-explanatory – when compared to standard pipette tips, epT.I.P.S. LoRetention showed markedly better results in terms of precision and sample recovery, as displayed in **Fig. 1 and 2**.

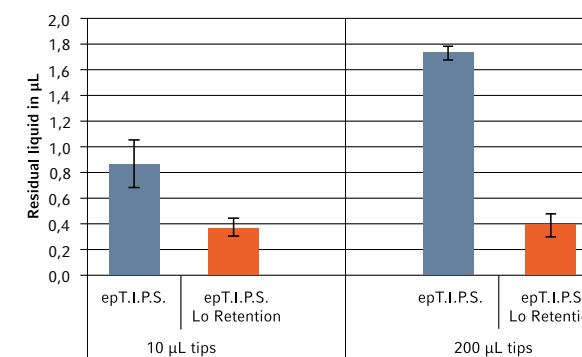

Fig. 1: Comparison of residual liquid of epT.I.P.S. and epT.I.P.S. LoRetention with master mix for *real-time* PCR. Once the liquid had been dispensed, the residual liquid in the tips was determined. The measurements were repeated several times and the standard deviation was determined. epT.I.P.S. LoRetention resulted in the lowest residual liquid.

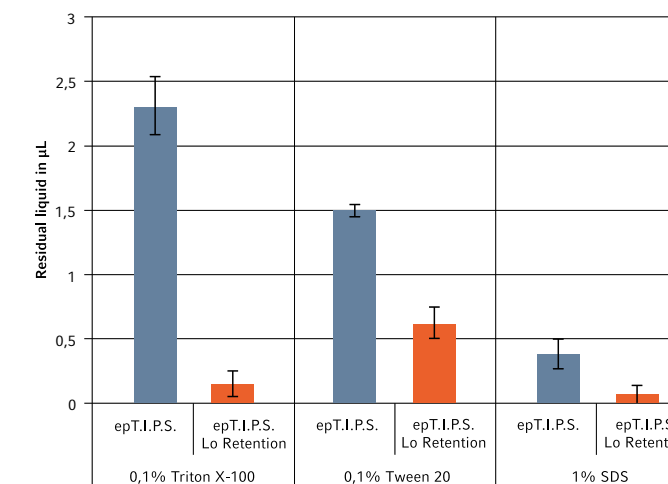









Fig. 2: Comparison of resistance of the low retention property when subjected to solvents typically used in proteomics. 200 µL epT.I.P.S. and epT.I.P.S. LoRetention were treated with the solvents specified. An enzymatic buffer containing detergents was then pipetted and the residual moisture was determined. epT.I.P.S. LoRetention resulted in reproducible low levels of residual liquids.

➤ For more information go to www.eppendorf.com/LoRetention



Volume range/epT.I.P.S.[®]
epT.I.P.S.[®] LoRetention
(all tips shown are actual size)







	Standard/Bulk	Reloads	Reloads
dark gray	1,000 tips (2 bags × 500 tips)	960 tips (10 trays × 96 tips)	960 tips (10 trays × 96 tips)
0.1 – 10 µL, 34 mm	0030 000 811	0030 073 371	0030 073 754
		0030 072 049 LoRetention	0030 072 006 LoRetention
medium gray	1,000 tips (2 bags × 500 tips)	960 tips (10 trays × 96 tips)	960 tips (10 trays × 96 tips)
0.1 – 20 µL, 40 mm	0030 000 838	0030 073 398	0030 073 770
			
light gray	1,000 tips (2 bags × 500 tips)	960 tips (10 trays × 96 tips)	960 tips (10 trays × 96 tips)
0.5 – 20 µL, 46 mm	0030 000 854	0030 073 410	0030 073 797
		0030 072 057 LoRetention	0030 072 014 LoRetention
yellow	1,000 tips (2 bags × 500 tips)	960 tips (10 trays × 96 tips)	960 tips (10 trays × 96 tips)
2 – 200 µL, 53 mm	0030 000 889	0030 073 436	0030 073 819
	0030 000 870 yellow tips	0030 072 065 LoRetention	0030 072 022 LoRetention
orange	1,000 tips (2 bags × 500 tips)	960 tips (10 trays × 96 tips)	960 tips (10 trays × 96 tips)
20 – 300 µL, 55 mm	0030 000 900	0030 073 452	0030 073 835
	0030 000 897 yellow tips		
blue	1,000 tips (2 bags × 500 tips)	960 tips (10 trays × 96 tips)	960 tips (10 trays × 96 tips)
50 – 1,000 µL, 71 mm	0030 000 927	0030 073 479	0030 073 851
	0030 000 919 blue tips	0030 072 073 LoRetention	0030 072 030 LoRetention
green	1,000 tips (4 bags × 250 tips)	960 tips (10 racks × 96 tips)	960 tips (10 trays × 96 tips)
50 – 1,250 µL, 76 mm	0030 000 935	0030 073 495	0030 073 878
			

¹⁾ This article is available from May 2020.



Box	Set	Singles	Racks
1 reusable box × 96 tips	480 tips (5 trays × 96 tips), 1 reusable box		
0030 073 010	0030 073 215		
New 0030 076 125 ¹⁾	New 0030 076 290 ¹⁾		
	New 0030 072 251 LoRetention		
	New 0030 072 367 ¹⁾ LoRetention		
1 reusable box × 96 tips	480 tips (5 trays × 96 tips), 1 reusable box	100 tips, individually packed	480 tips (5 racks × 96 tips)
0030 073 037	0030 073 231	0030 010 027	0030 075 226
New 0030 076 133 ¹⁾	New 0030 076 303 ¹⁾		
1 reusable box × 96 tips	480 tips (5 trays × 96 tips), 1 reusable box		
0030 073 053	0030 073 258		
New 0030 076 141 ¹⁾	New 0030 076 311 ¹⁾		
	New 0030 072 260 LoRetention		
	New 0030 072 375 ¹⁾ LoRetention		
1 reusable box × 96 tips	480 tips (5 trays × 96 tips), 1 reusable box	100 tips, individually packed	480 tips (5 racks × 96 tips)
0030 073 070	0030 073 274	0030 010 043	0030 075 234
New 0030 076 150 ¹⁾	New 0030 076 320 ¹⁾		
	New 0030 072 278 LoRetention		
	New 0030 072 383 ¹⁾ LoRetention		
1 reusable box × 96 tips	480 tips (5 trays × 96 tips), 1 reusable box		480 tips (5 racks × 96 tips)
0030 073 096	0030 073 290		0030 075 242
New 0030 076 168 ¹⁾	New 0030 076 338 ¹⁾		
1 reusable box × 96 tips	480 tips (5 trays × 96 tips), 1 reusable box	100 tips, individually packed	480 tips (5 racks × 96 tips)
0030 073 118	0030 073 312	0030 010 060	0030 075 250
New 0030 076 176 ¹⁾	New 0030 076 346 ¹⁾		
	New 0030 072 286 LoRetention		
	New 0030 072 391 ¹⁾ LoRetention		
1 reusable box × 96 tips	480 tips (5 trays × 96 tips), 1 reusable box		480 tips (5 racks × 96 tips)
0030 073 134	0030 073 339		0030 075 269
New 0030 076 184 ¹⁾	New 0030 076 354 ¹⁾		

Liquid Handling

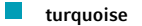
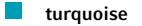
Volume range/epT.I.P.S. [®] epT.I.P.S. [®] LoRetention (all tips shown are actual size)	Standard/Bulk	Reloads	Reloads
 dark green	1,000 tips (4 bags × 250 tips)	960 tips (10 trays × 96 tips)	960 tips (10 trays × 96 tips)
50 – 1,250 µL L, 103 mm	0030 000 730	0030 073 630	0030 073 649
 red	500 tips (5 bags × 100 tips)	480 tips (10 trays × 48 tips)	480 tips (10 trays × 48 tips)
0.25 – 2.5 mL, 115 mm	0030 000 951	0030 073 517	0030 073 894
 violet	500 tips (5 bags × 100 tips)		
0.1 – 5 mL, 120 mm	0030 000 978		
 violet	300 tips (3 bags × 100 tips)		
0.2 – 5 mL L, 175 mm	0030 000 650		
 turquoise	200 tips (2 bags × 100 tips)		
0.5 – 10 mL, 165 mm	0030 000 765		
 turquoise	200 tips (2 bags × 100 tips)		
0.5 – 10 mL L, 243 mm	0030 000 781		

(Image reduced size)

¹⁾ This article is available from May 2020.

Liquid Handling

Box	Set	Racks
1 reusable box × 96 tips		480 tips (5 racks × 96 tips)
0030 073 657		0030 075 277 Biopur [®]
New 0030 076 192 ¹⁾		
1 reusable box × 48 tips	240 tips (5 trays × 48 tips), 1 reusable box	240 tips (5 racks × 48 tips)
0030 073 150	0030 073 355	0030 075 285 Biopur [®]
New 0030 076 206 ¹⁾	New 0030 076 362 ¹⁾	
1 reusable box × 24 tips		120 tips (5 racks × 24 tips)
0030 073 177		0030 075 293 Biopur [®]
New 0030 076 214 ¹⁾		0030 071 638 Eppendorf Quality [™]
		0030 071 662 PCR clean
		120 tips (5 racks × 24 tips)
		0030 075 307 Biopur [®]
		0030 071 646 Eppendorf Quality [™]
		120 tips (5 racks × 24 tips)
		0030 075 315 Biopur [®]
		0030 071 654 Eppendorf Quality [™]



Volume range/ ep Dualfilter T.I.P.S.®/
ep Dualfilter T.I.P.S.® LoRetention/
ep Dualfilter T.I.P.S.® SealMax



	Racks			
dark gray	960 tips (10 racks x 96 tips)			
0.1 – 10 µL S, 34 mm	0030 078 500	0030 078 632 LoRetention	0030 078 691 SealMax	
medium gray	960 tips (10 racks x 96 tips)			
0.1 – 10 µL M, 40 mm	0030 078 519		0030 078 810	
light gray	960 tips (10 racks x 96 tips)			
0.5 – 20 µL L, 46 mm	0030 078 527	0030 078 640 LoRetention	0030 078 705 SealMax	
yellow	960 tips (10 racks x 96 tips)			
2 – 20 µL, 53 mm	0030 078 535		0030 078 829	
yellow	960 tips (10 racks x 96 tips)			
2 – 100 µL, 53 mm	0030 078 543	0030 078 659 LoRetention	0030 078 713 SealMax	
yellow	960 tips (10 racks x 96 tips)			
2 – 200 µL, 55 mm	0030 078 551	0030 078 667 LoRetention	0030 078 721 SealMax	0030 078 837
orange	960 tips (10 racks x 96 tips)			
20 – 300 µL, 55 mm	0030 078 560	0030 078 675 LoRetention	0030 078 730 SealMax	
blue	960 tips (10 racks x 96 tips)			
50 – 1,000 µL, 76 mm	0030 078 578	0030 078 683 LoRetention	0030 078 748 SealMax	0030 078 845
dark green	480 tips (5 racks x 96 tips)			
50 – 1,250 µL L, 103 mm	0030 078 594			
red	240 tips (5 racks x 48 tips)			
0.25 µL – 2.5 mL, 115 mm	0030 078 586			

New



Volume range/ ep Dualfilter T.I.P.S.®/
ep Dualfilter T.I.P.S.® LoRetention/
ep Dualfilter T.I.P.S.® SealMax



	Racks
violet	120 tips (5 racks x 24 tips)
0.1 – 5 mL, 120 mm	0030 078 616
violet	120 tips (5 racks x 24 tips)
0.2 – 5 mL L, 175 mm	0030 078 624
turquoise	100 tips, individually packed
0.5 – 10 mL L, 243 mm	0030 077 598

(Image reduced size)

Special Tips



Volume range/ pipette tip

light gray	GELoader®
0.5 – 20 µL, 62 mm	192 tips (2 racks x 96 tips)
	0030 001 222
light gray	Microloader™
0.5 – 20 µL, 100 mm	192 pcs. (2 racks x 96 pcs.)
	5242 956 003
light gray	Mastertip®
20 µL, 52 mm	480 tips (5 racks x 96 tips)
	0030 001 320

Multipette® M4

Aspirate once and dispense up to 100 times

Serial pipetting made easy! The mechanical Multipette M4 is the ideal precision instrument for completing long pipetting or dispensing series. Even liquids which are difficult to pipette are no match for the Multipette/Combitips® system. Volumes are dispensed using the positive displacement principle. The liquid is directly dispensed without an air cushion, ensuring the correct volume is always dispensed regardless of the density, viscosity and volatility of the liquid.



Product features

- > Fill the tip once and dispense up to 100 times without a refill
- > Automatic Combitips recognition eliminates time consuming volume calculations
- > Easy-to-read display guarantees stress-free and intuitive operation
- > Dispensing volume is clearly displayed
- > Integrated »Sleep« function switches off when the Multipette M4 is not being used, thus reducing energy consumption
- > Stress-free work via integrated step counter: dispensing procedures can be continued error free after an interruption or distraction
- > Wide dispensing range: 1 µL to 10 mL for flexible operation
- > Fully emptied Combitips Tip can be easily ejected with one hand using the operating lever
- > Perfect for viscous or foaming solutions and liquids with high vapor pressure through positive displacement principle
- > Safe handling of toxic, radioactive or infectious material

Applications

- > Repetitive dispensing of volumes in long series such as tube or plate filling, aliquoting reagents and kit usage
- > Contamination-free dispensing of toxic, radioactive and other hazardous liquids
- > Precise and accurate dispensing of viscous solutions (e.g. glycerol) or liquids with high vapor pressure (e.g. ethanol)



Correct Handling of Difficult Liquids

Viscous liquids

Problem

Viscous liquids have a high resistance to flow (e.g. glycerol)

Recommendation

Usage of a positive displacement pipette for better flow behavior due to absence of air cushion

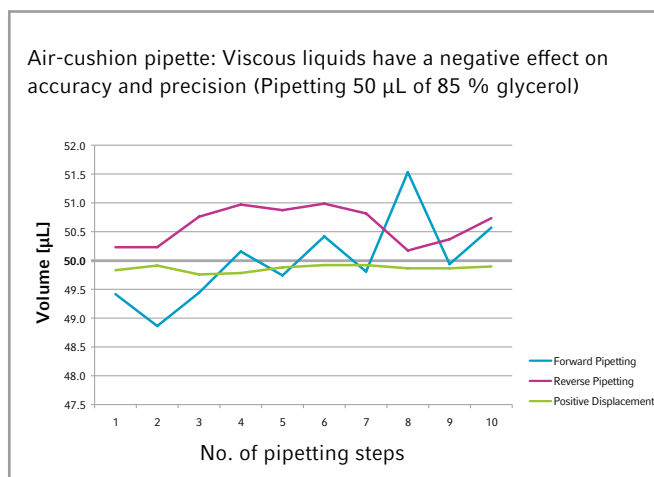

For more information go to www.eppendorf.com

Eppendorf Combitips advanced®	Min. volume	Max. volume	Increment	Volume	Systematic error ¹⁾	Random error ¹⁾
0.1 mL	1 µL	20 µL	1 µL	1 µL	±8.0 %	±13.0 %
				2 µL	±1.6 %	±3.0 %
				10 µL	±1.2 %	±2.4 %
				20 µL	±1.0 %	±2.0 %
0.2 mL	2 µL	40 µL	2 µL	2 µL	±6.0 %	±8.0 %
				4 µL	±1.3 %	±2.0 %
				20 µL	±0.8 %	±1.5 %
				40 µL	±0.8 %	±1.5 %
0.5 mL	5 µL	100 µL	5 µL	5 µL	±4.0 %	±8.0 %
				10 µL	±0.9 %	±1.5 %
				50 µL	±0.8 %	±0.8 %
				100 µL	±0.8 %	±0.6 %
1 mL	10 µL	200 µL	10 µL	10 µL	±4.0 %	±8.0 %
				20 µL	±0.9 %	±0.9 %
				100 µL	±0.6 %	±0.6 %
				200 µL	±0.6 %	±0.4 %
2.5 mL	25 µL	500 µL	25 µL	25 µL	±4.0 %	±8.0 %
				50 µL	±0.8 %	±0.8 %
				250 µL	±0.6 %	±0.6 %
				500 µL	±0.5 %	±0.3 %
5 mL	50 µL	1,000 µL	50 µL	50 µL	±3.0 %	±5.0 %
				100 µL	±0.6 %	±0.6 %
				500 µL	±0.5 %	±0.5 %
				1,000 µL	±0.5 %	±0.25 %
10 mL	100 µL	2,000 µL	100 µL	100 µL	±3.0 %	±4.0 %
				200 µL	±0.5 %	±0.6 %
				1,000 µL	±0.5 %	±0.4 %
				2,000 µL	±0.5 %	±0.25 %
25 mL	250 µL	5,000 µL	250 µL	250 µL	±3.0 %	±3.0 %
				500 µL	±0.4 %	±0.6 %
				2,500 µL	±0.3 %	±0.5 %
				5,000 µL	±0.3 %	±0.25 %
50 mL	500 µL	10,000 µL	500 µL	500 µL	±6.0 %	±10.0 %
				1,000 µL	±0.3 %	±0.5 %
				5,000 µL	±0.3 %	±0.5 %
				10,000 µL	±0.3 %	±0.25 %

¹⁾ The data for systematic and random errors, according to EN ISO 8655, only apply if original Eppendorf Combitips advanced are used.



Multipipette® M4

Volume table for using the Combitips advanced with the Multipipette M4

Position of the volume selection dial:		0.5	1	1.5	2	2.5	3	3.5	4	4.5	5
Maximum number of dispensing steps:		100	50	33	25	20	16	14	12	11	10
Combitips advanced with the following dispensing volumes:											
0.1 mL	1 µL	2 µL	3 µL	4 µL	5 µL	6 µL	7 µL	8 µL	9 µL	10 µL	
0.2 mL	2 µL	4 µL	6 µL	8 µL	10 µL	12 µL	14 µL	16 µL	18 µL	20 µL	
0.5 mL	5 µL	10 µL	15 µL	20 µL	25 µL	30 µL	35 µL	40 µL	45 µL	50 µL	
1.0 mL	10 µL	20 µL	30 µL	40 µL	50 µL	60 µL	70 µL	80 µL	90 µL	100 µL	
2.5 mL	25 µL	50 µL	75 µL	100 µL	125 µL	150 µL	175 µL	200 µL	225 µL	250 µL	
5.0 mL	50 µL	100 µL	150 µL	200 µL	250 µL	300 µL	350 µL	400 µL	450 µL	500 µL	
10 mL	100 µL	200 µL	300 µL	400 µL	500 µL	600 µL	700 µL	800 µL	900 µL	1.0 mL	
25 mL ¹⁾	250 µL	500 µL	750 µL	1.0 mL	1.25 mL	1.5 mL	1.75 mL	2.0 mL	2.25 mL	2.5 mL	
50 mL ¹⁾	500 µL	1.0 mL	1.5 mL	2.0 mL	2.5 mL	3.0 mL	3.5 mL	4.0 mL	4.5 mL	5.0 mL	

¹⁾ 25 and 50 mL Combitips can only be used with the corresponding adapter. Further information about Combitips advanced see page 77.

Volume table for using the Combitips advanced with the Multipipette M4

Position of the volume selection dial:		5.5	6	6.5	7	7.5	8	8.5	9	9.5	10
Maximum number of dispensing steps:		9	8	7	7	6	6	5	5	5	5
Combitips advanced with the following dispensing volumes:											
0.1 mL	11 µL	12 µL	13 µL	14 µL	15 µL	16 µL	17 µL	18 µL	19 µL	20 µL	
0.2 mL	22 µL	24 µL	26 µL	28 µL	30 µL	32 µL	34 µL	36 µL	38 µL	40 µL	
0.5 mL	55 µL	60 µL	65 µL	70 µL	75 µL	80 µL	85 µL	90 µL	95 µL	100 µL	
1.0 mL	110 µL	120 µL	130 µL	140 µL	150 µL	160 µL	170 µL	180 µL	190 µL	200 µL	
2.5 mL	275 µL	300 µL	325 µL	350 µL	375 µL	400 µL	425 µL	450 µL	475 µL	500 µL	
5.0 mL	550 µL	600 µL	650 µL	700 µL	750 µL	800 µL	850 µL	900 µL	950 µL	1.0 mL	
10 mL	1.1 mL	1.2 mL	1.3 mL	1.4 mL	1.5 mL	1.6 mL	1.7 mL	1.8 mL	1.9 mL	2.0 mL	
25 mL ¹⁾	2.75 mL	3.0 mL	3.25 mL	3.5 mL	3.75 mL	4.0 mL	4.25 mL	4.50 mL	4.75 mL	5.0 mL	
50 mL ¹⁾	5.5 mL	6.0 mL	6.5 mL	7.0 mL	7.5 mL	8.0 mL	8.5 mL	9.0 mL	9.5 mL	10.0 mL	

¹⁾ 25 and 50 mL Combitips can only be used with the corresponding adapter. Further information about Combitips advanced see page 77.

Ordering information

Description	Order no.
Multipipette® M4, single-channel, 1 µL – 10 mL	4982 000 012
Multipipette® M4 Starter Kit, single-channel, Multipipette® M4, Combitips® Rack, Combitips® assortment pack, 1 µL – 10 mL, holder for Carousel 2, Charger Carousel 2 or wall mounting	4982 000 314
Pipette Holder 2, for one Multipipette® M4, for Pipette Carousel 2 and Charger Carousel 2 or wall mounting, sticky tape included	3116 000 147
Battery 3V, CR2032	4980 215 003



Multipipette® E3/E3x

The expert for long series pipetting and liquids with demanding properties

Dispensing without compromise on accuracy and precision! With the electronic Multipipette E3/E3x you save time and money, work stress-free, and get reliable results. It is the ideal and smart solution for filling plates or large series of tubes. The light weight and minimal operation forces of the Multipipette E3 reduce the risk of repetitive strain injuries. The Multipipette/Combitips® system builds the perfect harmony allowing automatic tip recognition for ease of use. The syringe style Combitips tip maximizes pipetting accuracy and precision. It is not affected by liquid properties, most manual pipetting errors and provides protection from aerosol contamination.



Product features

- > Automatic Combitips recognition: Eliminates time-consuming volume calculations, avoiding incorrect dispensing volumes
- > Ergonomic one-button tip ejector: For one-handed operation and contact-free Combitips advanced ejection
- > Speed adjustment: Program aspiration and dispensing speed for the utmost in precision and accuracy while also preventing splashing
- > Fill the tip once and dispense up to 100 times without a refill
- > 1 µL to 50 mL dispensing range providing up to 5,000 dispensing volumes with increments as low as 100 nanoliters
- > Motor-driven function reduces the human error to a minimum and reduces risk of repetitive strain injuries (RSI)
- > Safe and ergonomic operation with 9 different selectable languages
- > Positive displacement system: Not affected by liquid properties, most manual pipetting errors and provides protection from aerosol contamination
- > Eppendorf TrackIT compatible: Editable data chip contains all relevant information (www.eppendorf.com/trackit)

Applications

- > Repetitive dispensing of volumes in long series such as tube or plate filling, aliquoting reagents and kit usage
- > Contamination-free dispensing for toxic, radioactive and other hazardous liquids
- > Precise and accurate dispensing of viscous solutions or liquids with high vapor pressure
- > Pooling of supernatants
- > Creation of dilution series
- > Concentration determination
- > Pooling and volume determination with subsequent dispensing

Correct Handling of Difficult Liquids

Liquids with high vapor pressure

Problem

Liquids with high vapor pressure force air cushion to expand (e.g. acetone)

Recommendation

Usage of a positive displacement pipette eliminates the problem due to absence of air cushion

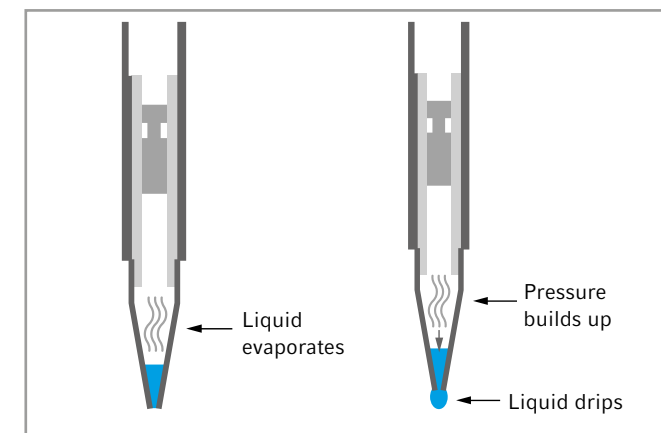

Multipette® E3/E3x



Work precisely and safely

The optimized system of Multipette and Combitips advanced allows automatic tip recognition for ease of use. The syringe style Combitips tip maximizes pipetting accuracy and precision. It is not affected by liquid properties, most manual pipetting errors and provides protection from aerosol contamination.

Eppendorf Combitips advanced®	Min. volume	Max. volume	Increment	Volume	Systematic error ¹⁾	Random error ¹⁾
0.1 mL	1 µL	100 µL	0.1 µL	1 µL	±11.0 %	±14.0 %
				10 µL	±1.6 %	±2.5 %
				50 µL	±1.0 %	±1.5 %
				100 µL	±1.0 %	±0.5 %
0.2 mL	2 µL	200 µL	0.2 µL	2 µL	±4.0 %	±5.5 %
				20 µL	±1.3 %	±1.5 %
				100 µL	±1.0 %	±1.0 %
				200 µL	±1.0 %	±0.5 %
0.5 mL	5 µL	500 µL	0.5 µL	5 µL	±3.0 %	±6.0 %
				50 µL	±0.9 %	±0.8 %
				250 µL	±0.9 %	±0.5 %
				500 µL	±0.9 %	±0.3 %
1 mL	10 µL	1 mL	1 µL	10 µL	±3.5 %	±7.0 %
				100 µL	±0.9 %	±0.55 %
				500 µL	±0.6 %	±0.30 %
				1,000 µL	±0.6 %	±0.20 %
2.5 mL	25 µL	2.5 mL	2.5 µL	25 µL	±2.0 %	±3.5 %
				250 µL	±0.8 %	±0.45 %
				1,250 µL	±0.5 %	±0.30 %
				2,500 µL	±0.5 %	±0.15 %
5 mL	50 µL	5 mL	5 µL	50 µL	±2.5 %	±6.0 %
				500 µL	±0.8 %	±0.35 %
				2,500 µL	±0.50 %	±0.25 %
				5,000 µL	±0.50 %	±0.15 %
10 mL	100 µL	10 mL	10 µL	100 µL	±1.5 %	±3.5 %
				1,000 µL	±0.5 %	±0.25 %
				5,000 µL	±0.4 %	±0.25 %
				10,000 µL	±0.4 %	±0.15 %
25 mL	250 µL	25 mL	25 µL	250 µL	±2.5 %	±3.0 %
				2,500 µL	±0.3 %	±0.35 %
				12,500 µL	±0.3 %	±0.25 %
				25,000 µL	±0.3 %	±0.15 %
50 mL	500 µL	50 mL	50 µL	500 µL	±2.0 %	±3.0 %
				5,000 µL	±0.3 %	±0.50 %
				25,000 µL	±0.3 %	±0.20 %
				50,000 µL	±0.3 %	±0.15 %

¹⁾ The data for systematic and random errors, according to EN ISO 8655, only apply if original Eppendorf Combitips advanced are used.

Multipette E3 and Multipette E3x at a glance	Multipette E3	Multipette E3x
High-speed dispensing with motorized piston	■	■
Automatic Combitips advanced® tip recognition	■	■
One-button tip ejection	■	■
Volume range from 1 µL to 50 mL, over 5,000 possible dispensing volumes	■	■
Big illuminated color display in 9 languages	■	■
Sleep mode saves battery when not in use	■	■
Long life Li-ion battery	■	■
Speed adjustment to match the viscosity of your liquid and the size of your vessel to prevent air bubbles and splashing	■	■
Options (Opt): Save favorite settings, set service intervals, activate key lock and more	■	■
Modes of operation	3	7
Pipetting (Pip): Precise liquid transfer of up to 50 mL	■	■
Dispensing (Dis): Serial dispensing for up to 100 steps in a row	■	■
Automatic dispensing (Ads): Volume is dispensed at fixed intervals between 0.1 s and 10 s	■	■
Sequential dispensing (Seq): Individual volume setting for up to 16 dispensing steps	■	■
Aspirate (Asp): consecutive aspiration of liquid for pooling into one Combitip	■	■
Aspirate and Dispense (A/D): Uptake and volume calculation of an unknown volume with immediate dispense in desired partial volumes	■	■
Titration (Tit): Sensitive dosing of liquids while dispensed volume is measured	■	■

Ordering information

Description	Order no.
Multipette® E3 , single-channel, with charging cable and Combitips advanced® assortment pack (1 Combitips® of each size), 1 µL – 50 mL	4987 000 010
Multipette® E3 bundle incl. charger stand , single-channel, with charging cable and Combitips advanced® assortment pack (1 Combitips® of each size), 1 µL – 50 mL	4987 000 371
Multipette® E3x , single-channel, with charging cable and Combitips advanced® assortment pack (1 Combitip of each size), 1 µL – 50 mL	4987 000 029
Multipette® E3x bundle incl. charger stand , single-channel, with charging cable and Combitips advanced® assortment pack (1 Combitip of each size), holder for Carousel 2, Charger Carousel 2 or wall mounting, 1 µL – 50 mL	4987 000 380
Pipette Holder 2 , for one Multipette® E3/E3x or Multipette® stream/Xstream, for Pipette Carousel 2 or wall mounting, sticky tape included, without charging functionality	3116 000 139
Power supply with power plug adapters , for pipettes and charger stand	4986 603 005

► Further information about Combitips advanced see on page 77

ViscoTip®

For mastering highly viscous liquids with your Multipette® from Eppendorf

Experience the new member of the Combitips advanced® dispenser tip family. The ViscoTip is specifically designed and optimized for handling high viscosity liquids up to 14,000 mPa*s such as glycerol 99.5 %, Tween, oils, creams, shampoos or honey. It sharply reduces operating forces while handling such liquids leading to enhanced ergonomics, increased working speed and longer charge lifetime of your Multipette battery.



Product features

- > Specialized for liquids with a dynamic viscosity from 200 mPa*s to 14,000 mPa*s
- > For dispensing volumes from 100 µL to 10 mL in increments of 10 µL
- > Make life easier for your instrument: The new design of the tip means significantly lower operation forces are used, thus it speeds up work and reduces energy consumption
- > Don't waste time calculating: Automatic tip recognition and volume calculation in Multipette M4/E3/E3x
- > Free of leachables and slip agents: The ViscoTip is free of experiment-interfering leachables (e.g. slip agents, biocides, plasticisers)
- > Save time finding the right tip: The color coded double ring and the continuous volume scale distinguish the ViscoTip from Combitips advanced

Applications

- > Positive displacement principle (comparable to a syringe)
- > For highly viscous liquids
- > Quick dispensing of long series with precise, repeated dispensing of identical volumes (with Multipette hand dispensers)

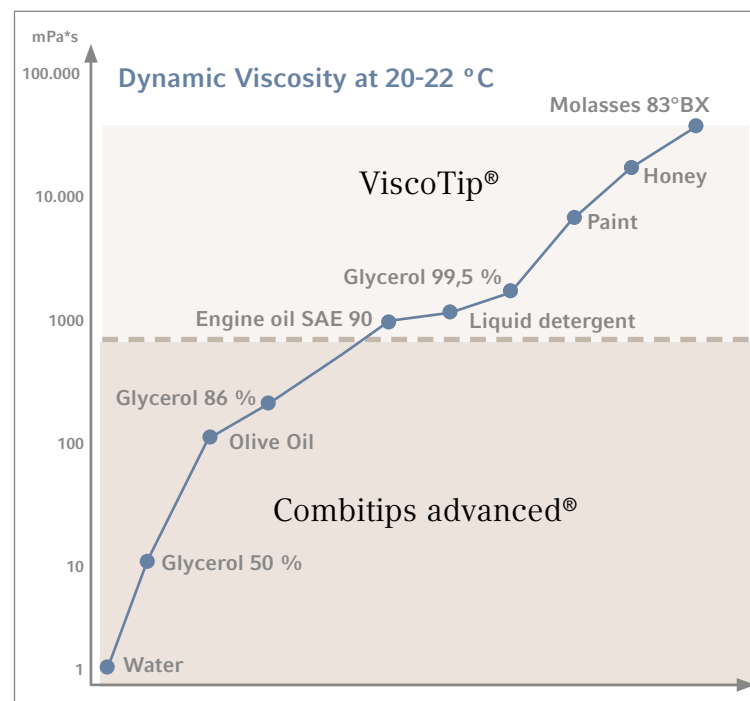

Combitips advanced®

The ideal system components for all Multipette pipettes from Eppendorf

In 1978 Eppendorf revolutionized the industry and laboratory workflow with the introduction of the Combitip/Multipette system and has been the leader in market innovations for nearly 40 years. The Combitips advanced have been completely redesigned and optimized to meet the needs of modern laboratory. The Combitips advanced also function according to the positive displacement principle, thus they always dispense the correct volume independently of the density of the liquid and its flow characteristics (e.g., increased vapor pressure or increased viscosity). Working with radioactive or toxic materials also becomes safer due to the hermetically sealed piston preventing aerosol contamination.

Product features

- > Combitips advanced are the ideal system components for all Multipette pipettes of Eppendorf
- > The 9 volume sizes (0.1 mL – 50 mL) offer a maximum range of dispensing volumes with increments as low as 100 nanoliters depending on the Combitips used
- > Elongated Combitips in volumes 2.5 mL, 5.0 mL and 10 mL make it possible to reach the bottom of the most common laboratory vessels
- > An individual color coding facilitates the quick identification of the desired Combitips
- > The unique funnel geometry ensures comfortable handling while preventing damage to gloves
- > Combitips advanced are offered in different purity grades to support a range of applications
- > The appropriate purity grade for each application: Eppendorf Quality™, PCR Clean, Forensic DNA Grade or Biopur®

Applications

- > Positive displacement principle (comparable to a syringe)
- > High-precision dispensing regardless of the physical properties of the liquid (e.g., viscosity, volatility, density, temperature...)
- > Prevents aerosol contamination with hermetically sealed piston for secure dispensing
- > Provides protection from radioactive and toxic substances
- > Quick dispensing of long series with precise, repeated dispensing of identical volumes (with Multipette hand dispensers)



Always easy to reach

The new Combitips Rack features trouble-free and single-hand operation during dispensing work. The rack holds up to 8 Combitips advanced in sizes ranging from 0.1 mL to 10 mL. The transparent tray allows for the sizes of the Combitips to be easily identified using the color coding.

Combitips advanced®

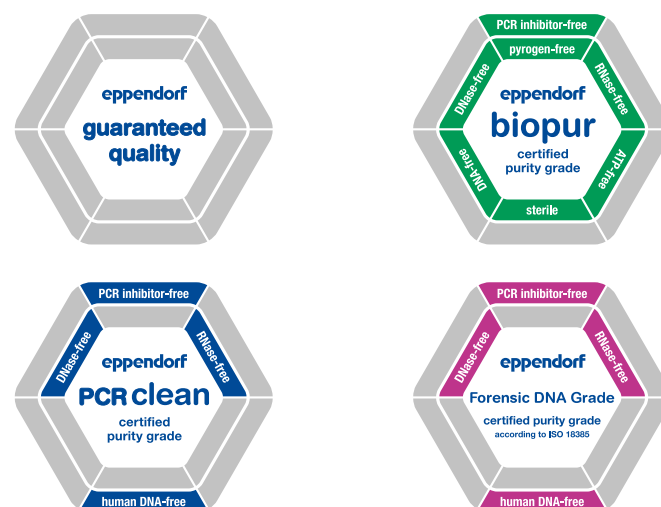

Unmistakably Eppendorf

The Eppendorf Combitips advanced features the characteristic Eppendorf 3D design on the upper rim of the Combitips, allowing you to easily and confidently recognize the Eppendorf original!

Variety and selection

4 purity grades (Eppendorf Quality, PCR clean, Biopur® and Eppendorf Forensic DNA Grade) are available, so that you will always find the perfect Combitips Tip for your application! The Eppendorf Biopur and Forensic DNA Grade Combitips advanced are individually blister-wrapped and feature an access tab which makes them easier to open, even with gloves!

Technical Specifications Combitips advanced®	Eppendorf Safe-Lock Tubes			Conical Tubes		Eppendorf Deepwell Plates		
	0.5 mL	1.5 mL	2.0 mL	15 mL	50 mL	96/500 µL	96/1000 µL	96/2000 µL
0.1 mL	+	+	+	-	-	+	+	+
0.2 mL	+	+	+	-	-	+	+	+
0.5 mL	+	+	+	-	-	+	+	+
1.0 mL	+	+	+	-	-	+	+	+
2.5 mL	++	++	++	++	++	+	++	++
5.0 mL	+	+	+	++	++	+	+	+
10 mL	+	+	+	-	++	+	+	+
25 mL	-	+	+	-	-	+	+	+
50 mL	-	+	+	-	-	+	+	+
10 mL	+	+	+	-	++	+	+	+

++ = improved compatibility compared to Combitip plus generation



Ordering information

Combitips advanced®	Color code	Eppendorf Quality™ 100 pcs. (4 bags × 25 pcs.)	PCR clean 100 pcs. (4 reclosable bags × 25 pcs.)	Biopur® 100 pcs., individually blister- wrapped	Forensic DNA Grade 100 pcs., individually blister- wrapped
0.1 mL	□ white	0030 089 405	0030 089 766	0030 089 618	
0.2 mL	□ light blue	0030 089 413	0030 089 774	0030 089 626	
0.5 mL	□ violet	0030 089 421	0030 089 782	0030 089 634	
1.0 mL	□ yellow	0030 089 430	0030 089 790	0030 089 642	0030 089 855
2.5 mL	□ green	0030 089 448	0030 089 804	0030 089 650	0030 089 863
5.0 mL	□ blue	0030 089 456	0030 089 812	0030 089 669	0030 089 871
10 mL	□ orange	0030 089 464	0030 089 820	0030 089 677	
25 mL ¹⁾	□ red	0030 089 472	0030 089 839	0030 089 685	
50 mL ¹⁾	□ light gray	0030 089 480	0030 089 847	0030 089 693	
ViscoTip®					
10 mL	□ orange	0030 089 502			
Accessories					
Adapter advanced					
25 mL, autoclavable, 1 piece	■ red	0030 089 715			
25 mL, autoclavable, 7 pcs., individually wrapped	■ red			0030 089 731	
50 mL, autoclavable, 1 piece	■ light gray	0030 089 723			
50 mL, autoclavable, 7 pcs., individually wrapped	■ light gray			0030 089 740	
Combitips advanced® Rack, for 8 Combitips advanced (0.1 – 10 mL)		0030 089 758			
Combitips advanced® Assortment Pack, contains one sample of each size, adapter advanced 25 and 50 mL, one piece each		0030 089 936			

¹⁾ 4 boxes of 25 pcs. each. Each box containing one adapter.

Varipette® 4720



The large volume pipette for large bottles or tall, narrow vessels

The Varipette® 4720 is a large volume pipette optimized for work with viscous or high-vapor pressure solutions. It also allows for aspirating liquids from large bottles or tall, narrow vessels when using the Varitip S system. Its super easy, one-hand operation significantly speeds up pipetting tasks: Simply press down the operating lever to aspirate liquid from the reservoir. Press the lever again and the liquid will be dispensed into your sample vessel.

Product features

- > Volume range: 1 mL to 10 mL
- > Fast pipetting and convenient operation due to unique one-hand operation. Liquid automatically aspirates and dispenses by simply pressing the operating lever
- > 4-digit volume display and adjustable in 10 µL increments for accurate volume setting
- > Eppendorf Varitips® P (fig.1) is a syringe-style, positive displacement tip that allows for accurate pipetting of viscous solutions or liquids with high-vapor pressure
- > The Eppendorf Varitips S system, consisting of the dispensing part (fig.2) and Maxitip (fig.3), is optimized for aspirating liquids from large bottles or tall, narrow vessels
- > The valve for use together with the Varitips S system ensures drip-free dispensing of volatile solutions

Combination	Volume range	Volume	Rel. systematic error ¹⁾	Abs. systematic error ¹⁾	Rel. random error ¹⁾	Abs. random error ¹⁾
Varipette 4720 and Varitips S system	2.5 – 10 mL	2.5 mL	±1.0 %	0.025 mL	±0.2 %	0.005 mL
		5 mL	±0.4 %	0.02 mL	±0.2 %	0.01 mL
		10 mL	±0.3 %	0.03 mL	±0.2 %	0.02 mL
Varipette 4720 and Varitips P	1 – 10 mL	1 mL	±0.6 %	0.006 mL	±0.2 %	0.002 mL
		5 mL	±0.5 %	0.025 mL	±0.1 %	0.005 mL
		10 mL	±0.3 %	0.03 mL	±0.1 %	0.01 mL

¹⁾ The error data, according to EN ISO 8655, only apply if original Eppendorf tips are used. Technical specifications are subject to change. Errors and omissions excepted.

Ordering information

Description	Order no.
Varipette® 4720, single-channel, with continuous volume selection in the 1 – 10 mL range, 1 – 10 mL	4720 000 011
Eppendorf Varitips® P, to remove liquid from smaller vessels, 100 pieces	0030 048 130
Eppendorf Varitips® S Starter Kit, to remove liquid from narrow-necked vessels and measuring flasks, consisting of 100 Maxitips, 10 dispensing parts, 10 valves	0030 050 525
Eppendorf Varitips® S dispensing part, 30 pieces	0030 050 533
Eppendorf Varitips® S, graduated, 200 pieces	0030 050 568
Eppendorf Varitips® S valve, 100 pieces	0030 050 541

Eppendorf TrackIT



Description

Manage your Eppendorf pipettes with Eppendorf TrackIt. Instantly know the essential information of each pipette without searching the pipette in the whole lab. Eppendorf pipettes have a data chip molded in that can be read or edited by the TrackIt reader. All information is centrally stored in the TrackIt Software and can automatically be transferred in your lab data base. To increase the traceability of your pipette portfolio Eppendorf offers Eppendorf TrackIT. This product contains a RFID reader and software.

Applications

- > Central documentation of all relevant pipette inventory data
- > Make all relevant instrument information available for digital documentation
- > Documentation of service history
- > Unambiguous instrument identification
- > Traceability of instruments used in an experiment
- > Undetachable individual identification of the instrument

Ordering information

Description	Order no.
Eppendorf TrackIT, RFID Reader and Software	3903 000 014

Technical specifications subject to change.

Easypet® 3

Designed to work in perfect harmony with your Eppendorf Serological Pipets

Experience a new dimension of electronic pipetting with the Easypet® 3. The latest technological developments give you complete speed control with the utmost precision. The lightweight, well-balanced Easypet 3 has been designed considering all ergonomic findings to fit comfortably in your hand and matches its shape to allow for fatigue-free pipetting.



Product features

- > Intuitive and convenient speed adjustment simply done with the tips of your fingers
- > Lightweight, well-balanced and ergonomic design that allows for fatigue-free pipetting
- > Vibrant backlit LEDs provide optical feedback of the remaining battery life
- > Lithium polymer rechargeable battery offers long cordless runtime
- > Smooth setting of pump speed
- > Operation while recharging is possible
- > Autoclavable pipette adapter for sterile applications
- > Quick release of aspirating cone for easy exchange of membrane filters

Applications

- > Pipette controller for use with pipettes from 0.1 – 100 mL
- > Serial dispensing of aliquots of different volumes
- > Resuspension of bacteria or cell pellets
- > Aspiration of cell layer from, e.g., Ficoll® gradient

Technical specifications

Model	Easypet® 3
Weight	160 g
Rechargeable battery	
Capacity	1,100 mAh/3.7 V
Charging time	~3 h
Type	Lithium polymer
Channel type	single-channel
Number of dispensings	~2,000 (with a 25 mL pipette)
Operation	Electronic
Pipetting type	Air-cushion
Mains/power supply	
Input	100 V – 240 V AC ± 10 %, 50 Hz – 60 Hz, 0.5 A
Output	5 V DC, 1.0 A

Ordering information

Description	Order no.
Easypet® 3, single-channel, incl. mains/power supply device, wall mounting device, shelf stand, 2 membrane filters 0.45 µm, 0.1 – 100 mL	4430 000 018
Membrane filter, sterile, 5 pcs., 0.2 µm	4430 606 005
Membrane filter, sterile, 5 pcs., 0.45 µm	4421 601 009
Lithium polymer rechargeable battery	4430 605 009

Your local distributor: www.eppendorf.com/contact

Eppendorf AG · Barkhausenweg 1 · 22339 Hamburg · Germany · eppendorf@eppendorf.com · www.eppendorf.com · www.eppendorf.com/eshop



Pipet Helper®

A perfect entry-level model

The Pipet Helper is the perfect instrument for inexperienced users as its robust and intuitive design allows everybody to adjust the meniscus precisely. In addition, the valve unit is optimized so that liquids can be drawn up simply, without exerting pressure. The aspiration bulb provides rapid filling of the pipet. The aspiration and dispensing of liquids are controlled gently by the ergonomic lever. Additionally, a splash free blow-out is provided. The specially designed aspirating cone ensures secure seating for all measuring and volumetric pipets (glass and plastic).



Product features

- > Lightweight with reduced operating force
- > Easy maintenance and cleaning due to easy disassembly, few parts and fully autoclavable
- > Comfortable working because of the good balance and pleasing material
- > The aspirating bulb enables pipetting of volumes up to 100 mL at once
- > Single lever controls low force aspirating and dispensing
- > High control over the liquid movement due to very sensitive valve unit
- > Drop wise dispensing and blow out without splashing
- > Drainage without any additional pressure delivers very reproducible results
- > Drip stop via hydrophobic membrane filter (3 µm)
- > The special silicon pipet adapter guarantees a secure pipette fit

Applications

- > Preparation of a buffer for chromatography
- > Preparation of a fluid for fermentation
- > Sample transfer within petrochemistry
- > Generate a sample within water analytics
- > Preparation of assays

Ordering information

Description	Order no.
Pipet Helper®, single-channel, 0.1 – 100 mL	4423 000 010
Membrane filter, 3 µm, non-sterile, 10 pieces	4423 601 014



Eppendorf Serological Pipets

Designed to work in perfect harmony with your Easypet® 3

Eppendorf completes its portfolio in liquid handling with the new line of Eppendorf Serological Pipets. Experience the quality and convenience in liquid handling you have trusted in for decades with Eppendorf's system: Easypet 3 and Eppendorf Serological Pipets. Eppendorf serological pipets are designed to work in perfect harmony with your Easypet 3. The pipets offer precise graduations overlaid on the ultra-clear pipet material to facilitate quick and easy reading of the volume. The pipets are individually wrapped and packaged in a robust dispenser box to ensure consistent premium quality.



Product features

- > Clear and precise graduations for easy volume determination
- > Color-coding for easy identification of pipet sizes
- > Subunits with dispenser option to keep stored products safe
- > Individually wrapped pipets for reliable sterility
- > Ultra-pure virgin polystyrene meeting the requirement of USP VI
- > Harmonized and well-fitting operation with Easypet 3, compatibility with all existing pipet helpers
- > Sterility assurance level of 10⁻⁶
- > Certified absence of detectable pyrogens, DNA, RNase and DNase
- > Certified non-cytotoxic

Ordering information

Description	Color code	Volume	Order no.
Eppendorf Serological Pipets, sterile, free of detectable pyrogens, DNA, RNase and DNase. Non-cytotoxic			
Sterile, 800 pcs. (4 bags × 200 pcs.)	yellow	1 mL	0030 127 692
Sterile, 600 pcs. (4 bags × 150 pcs.)	green	2 mL	0030 127 706
Sterile, 400 pcs. (4 bags × 100 pcs.)	blue	5 mL	0030 127 714
Sterile, 400 pcs. (4 bags × 100 pcs.)	orange	10 mL	0030 127 722
Sterile, 200 pcs. (4 bags × 50 pcs.)	red	25 mL	0030 127 730
Sterile, 160 pcs. (4 bags × 40 pcs.)	violet	50 mL	0030 127 749

Varispenser® 2/Varispenser® 2x

Safe and easy dispensing of liquids from bottles without compromise

The new Varispenser 2 and Varispenser 2x are the ideal choice for dispensing aliquots of liquid from supply and reagent bottles. Advanced sealing lip technology enables dispensing of nearly all kinds of acids, solutions or bases. Available in 6 sizes for dispensing volumes from 0.2 – 100 mL, these instruments are designed to consistently dispense selected volumes without reagent waste. All Varispenser bottle-top dispensers are fully autoclavable for maximized safety in your lab. The Varispenser 2x has a recirculation valve which prevents reagent loss while ventilating.



Product features

- > Standard GL 45 thread for most common bottle threads on all sizes
- > Safety valve balls in discharge valve prevent leakage when discharge tube is not mounted
- > Air vent cap can be unscrewed for easy assembly of drying tube
- > Oval-shaped dispenser housing for easy transportation
- > PFA seal of the sliding piston prevents seizing up
- > Fixation slide on interior toothed track for rapid and safe volume adjustment
- > High chemical resistance of all dispensing components
- > Telescopic aspirating tubes for variable adjustment to bottle height
- > Fully autoclavable without disassembly
- > Both models are available in 6 sizes for dispensing volumes from 0.2 – 100 mL

Applications

- > Liquid dispensing directly from supply bottles or other big laboratory vessels containing aqueous liquids, lyes, acids, bases or solvents

Ordering information

Volume range	Volume	Dispensing step	Rel. systematic error ¹⁾	Abs. systematic error ¹⁾	Rel. random error ¹⁾	Abs. random error ¹⁾	Order no.
Varispenser® 2 , single-channel, bottle top dispenser with adapters GL 25, GL 28/S 28, GL 32, GL 38, S 40 and telescopic intake tube (length 125 – 240 mm)							
0.2 – 2 mL	0.2 mL	0.05 mL	±5 %	±10 µL	±1 %	±2 µL	4966 000 010
	1 mL	0.05 mL	±1 %	±10 µL	±0.2 %	±2 µL	
	2 mL	0.05 mL	±0.5 %	±10 µL	±0.1 %	±2 µL	
0.5 – 5 mL	0.5 mL	0.1 mL	±5 %	±25 µL	±1 %	±5 µL	4966 000 029
	2.5 mL	0.1 mL	±1 %	±25 µL	±0.2 %	±5 µL	
	5 mL	0.1 mL	±0.5 %	±25 µL	±0.1 %	±5 µL	
1 – 10 mL	1 mL	0.2 mL	±5 %	±50 µL	±1 %	±10 µL	4966 000 037
	5 mL	0.2 mL	±1 %	±50 µL	±0.2 %	±10 µL	
	10 mL	0.2 mL	±0.5 %	±50 µL	±0.1 %	±10 µL	
Varispenser® 2 , single-channel, bottle top dispenser with adapters GL 32, GL 38, S 40 and telescopic intake tube (length 170 – 330 mm)							
2.5 – 25 mL	2.5 mL	0.5 mL	±5 %	±120 µL	±1 %	±25 µL	4966 000 045
	12.5 mL	0.5 mL	±1 %	±120 µL	±0.2 %	±25 µL	
	25 mL	0.5 mL	±0.5 %	±120 µL	±0.1 %	±25 µL	
5 – 50 mL	5 mL	1 mL	±5 %	±250 µL	±1 %	±50 µL	4966 000 053
	25 mL	1 mL	±1 %	±250 µL	±0.2 %	±50 µL	
	50 mL	1 mL	±0.5 %	±250 µL	±0.1 %	±50 µL	
10 – 100 mL	10 mL	1 mL	±5 %	±500 µL	±1 %	±100 µL	4966 000 061
	50 mL	1 mL	±1 %	±500 µL	±0.2 %	±100 µL	
	100 mL	1 mL	±0.5 %	±500 µL	±0.1 %	±100 µL	
Varispenser® 2x , single-channel, bottle top dispenser with recirculation valve with adapters GL 25, GL 28/S 28, GL 32, GL 38, S 40 and telescopic intake tube (length 125 – 240 mm)							
0.2 – 2 mL	0.2 mL	0.5 mL	±5 %	±10 µL	±1 %	±2 µL	4967 000 014
	1 mL	0.5 mL	±1 %	±10 µL	±0.2 %	±2 µL	
	2 mL	0.5 mL	±0.5 %	±10 µL	±0.1 %	±2 µL	
0.5 – 5 mL	0.5 mL	0.1 mL	±5 %	±25 µL	±1 %	±5 µL	4967 000 022
	2.5 mL	0.1 mL	±1 %	±25 µL	±0.2 %	±5 µL	
	5 mL	0.1 mL	±0.5 %	±25 µL	±0.1 %	±5 µL	
0.1 – 10 mL	1 mL	0.2 mL	±5 %	±50 µL	±1 %	±10 µL	4967 000 030
	5 mL	0.2 mL	±1 %	±50 µL	±0.2 %	±10 µL	
	10 mL	0.2 mL	±0.5 %	±50 µL	±0.1 %	±10 µL	
Varispenser® 2x , single-channel, bottle top dispenser with recirculation valve with adapters GL 32, GL 38, S 40 and telescopic intake tube (length 170 – 330 mm)							
2.5 – 25 mL	2.5 mL	0.5 mL	±5 %	±120 µL	±1 %	±25 µL	4967 000 049
	12.5 mL	0.5 mL	±1 %	±120 µL	±0.2 %	±25 µL	
	25 mL	0.5 mL	±0.5 %	±120 µL	±0.1 %	±25 µL	
5 – 50 mL	5 mL	1 mL	±5 %	±250 µL	±1 %	±50 µL	4967 000 057
	25 mL	1 mL	±1 %	±250 µL	±0.2 %	±50 µL	
	50 mL	1 mL	±0.5 %	±250 µL	±0.1 %	±50 µL	
10 – 100 mL	10 mL	1 mL	±5 %	±500 µL	±1 %	±100 µL	4967 000 065
	50 mL	1 mL	±1 %	±500 µL	±0.2 %	±100 µL	
	100 mL	1 mL	±0.5 %	±500 µL	±0.1 %	±100 µL	

¹⁾ The data for systematic error and random error are given according to EN ISO 8655. Technical specifications are subject to change. Errors and omissions excepted. The Varispenser® (plus) is not a substitution for a bottle closure. Volatile liquids can disappear.

Eppendorf Top Buret™

Continuous and pulse-free manual titration

The Eppendorf Top Buret sets standards for manual titration. With each turn of the dial, liquid is continuously dispensed. This eliminates the need for new liquid aspiration and makes titration simpler and safer. The Top Buret comes in two different models: Model M features a dispensing rate of 2,500 µL per rotation; Model H features a rate of 5,000 µL per rotation. The digital display readings on both models range from 10 µL to 999.9 mL with the size of your supply bottle being the only limiting factor. Its clearly labeled user-friendly digital display and simple knob control provides for easy, ergonomic and fatigue-free operation.



Product features

- > Continuous, pulse-free dispensing technology
- > Recirculation valve with valve lever
- > Voltage supply with longerlife battery and battery status indicator
- > Dispensing range 0.1 mL to 999.9 mL
- > Electronic control pad can be removed as unit
- > Service-friendly modular design incl. simple calibration program
- > High chemical resistance
- > Variable discharge tube, horizontal 142 – 220 mm, vertical 10 – 200 mm and rotatable by 360°
- > Telescopic aspirating tube for automatic length adjustment of 210 – 370 mm
- > Suitable for GL 32, GL 38, GL 45 and S 40 buttress thread with included adapters. Additional adapters available

Ordering information

Volume range	Volume	Rel. systematic error ¹⁾	Abs. systematic error ¹⁾	Rel. random error ¹⁾	Abs. random error ¹⁾	Order no.
Eppendorf Top Buret™ M						
0.1 – 999.9 mL	2.5 mL	±2.0 %	±0.05 mL	±1.0 %	±0.025 mL	4965 000 017
	12.5 mL	±0.4 %	±0.05 mL	±0.2 %	±0.025 mL	
	25 mL	±0.2 %	±0.05 mL	±0.1 %	±0.025 mL	
Eppendorf Top Buret™ H						
0.1 – 999.9 mL	5 mL	±2.0 %	±0.1 mL	±1.0 %	±0.05 mL	4965 000 025
	25 mL	±0.4 %	±0.1 mL	±0.2 %	±0.05 mL	
	50 mL	±0.2 %	±0.1 mL	±0.1 %	±0.05 mL	

¹⁾ The data for systematic error and random error are given according to EN ISO 8655. Technical specifications are subject to change. Errors and omissions excepted. The Varispenser® (plus) is not a substitution for a bottle closure. Volatile liquids can disappear.

Accessories

Description	Order no.
Telescopic aspirating tube from FEP, 125 mm – 240 mm, for 2 mL, 5 mL, 10 mL	4966 504 000
Telescopic aspirating tube from FEP, 170 mm – 330 mm, for 25 mL, 50 mL, 100 mL	4966 507 000
Telescopic aspirating tube from FEP, 195 mm – 350 mm, for 2 mL, 5 mL, 10 mL	4966 505 007
Telescopic aspirating tube from FEP, 250 mm – 480 mm, for 2 mL, 5 mL, 10 mL	4966 506 003
Telescopic aspirating tube from FEP, 250 mm – 480 mm, for 25 mL, 50 mL, 100 mL	4966 508 006
Telescopic aspirating tube from FEP, 70 mm – 140 mm, for 2 mL, 5 mL, 10 mL	4966 503 004
Telescopic aspirating tube, 2.5 mL, 5 mL, 10 mL, 25 mL, 50 mL, 100 mL	4960 805 009
Bottle thread adapter, PP, from GL 32 to GL 25	4960 800 040
Bottle thread adapter, PP, from GL 32 to GL 27	4960 800 139
Bottle thread adapter, PP, from GL 32 to GL/S 28	4960 800 058
Bottle thread adapter, PP, from GL 32 to NS 19/26	4960 800 082
Bottle thread adapter, PP, from GL 32 to NS 24/29	4960 800 090
Bottle thread adapter, PP, from GL 32 to NS 29/32	4960 800 104
Bottle thread adapter, PP, from GL 45 to GL 32	4960 800 120
Bottle thread adapter, PP, from GL 45 to GL 38	4960 800 155
Bottle thread adapter, PP, from GL 45 to S 40	4960 800 147
Bottle thread adapter, ETFE, from GL 32 to GL/S 28	4960 835 005
Bottle thread adapter, ETFE, from GL 45 to GL 38	4960 839 000
Bottle thread adapter, PTFE, from GL 45 to S 40	4960 834 009
Bottle thread adapter, ETFE, from GL 32 to GL 25	4966 614 000
Bottle thread adapter, ETFE, from GL 45 to GL 32	4966 615 007
Discharge tube, spiraled	
for 2 mL, 5 mL, 10 mL	4966 501 001
for 25 mL, 50 mL, 100 mL	4966 502 008
Drying tube	
without filling, including sealing washer (PFTE)	4966 509 002
Drying tube , without drying agent	4960 851 000
Ventilation screw , for microfilers with Luer connector, PP, with PTFE sealing washer	4966 511 007
Thread adapter for jerrycan 5L from 45 mm to 17/8" thread , ETFE	4960 832 006

epMotion® 96 and 96xl



Product features

- > 0.5 to 300 µL or 5 to 1,000 µL with one system
- > Electronic pipetting with synchronous 96 channel piston movement for better precision and reproducibility of results
- > Auto-detect function for tip size
- > Use two sizes of reload tips for best accuracy
- > Intuitive and industry proven software concept and convenient touch screen control
- > Intelligent, preset applications: (multi) aspiration, dilution, multi dispense, pipette and mix, manual pipetting, small volume, reverse pipette
- > Individual speed setting, set parameters you are comfortable with and that match the liquid class
- > Easy and rapid tip load and reloading
- > Compact design to fit in a laminar flow hood
- > Reduced risk of repetitive strain injury (RSI)

Applications

- > Replication and reformatting of microplates
- > PCR setup in 96 well format
- > Cell seeding and media change
- > Reagent and compound addition
- > 384 wells by 4 times 96 well pipetting
- > Cell-based assays
- > ELISA handling (plate coating and wash)
- > Biochemical assays
- > Nucleic acid purification in 96-well format (e.g. magnetic bead-based)



Ordering information

Description	Order no.
epMotion® 96 , 96-channel, semi-automated electronic pipette for parallel 96 channel microplate processing (without iPod® controller), 100 – 240 V ±10 %/50 – 60 Hz ±5 %, 0.5 – 300 µL	5069 000 012
epMotion® 96 with 2-position slider , 96-channel, with 2-position slider, semi-automated electronic pipette for parallel 96 channel microplate processing (without iPod® controller), 100 – 240 V ±10 %/50 – 60 Hz ±5 %, 0.5 – 300 µL	5069 000 110
epMotion® 96xl , 96-channel, semi-automated electronic pipette for parallel 96 channel microplate processing (without iPod® controller), 100 – 240 V ±10 %/50 – 60 Hz ±5 %, 5 – 1,000 µL	5069 000 217
epMotion® 96xl with 2-position slider , 96-channel, semi-automated electronic pipette for parallel 96 channel microplate processing (without iPod® controller), 100 – 240 V ±10 %/50 – 60 Hz ±5 %, 5 – 1,000 µL	5069 000 314
epMotion® 96 Accessories , Upgrade set 2-position slider for epMotion® 96	5069 074 008
epMotion® reservoir 195 mL , low dead volume reservoir, single well with 96 cavities, PCR clean, 4 x 5 reservoirs	0030 126 556

✎ Ordering information for other voltage options begins on page 450

i For more information go to www.eppendorf.com

Technical specifications subject to change.

epMotion® 5070/5070f



Product features

- > 4 ANSI/SLAS worktable and unlimited virtual positions
- > Maximum pipetting accuracy from 0.2 to 1,000 µL
- > Calibrated 1-channel and 8-channel pipetting tools
- > Optical sensor¹⁾ for detecting liquids, labware and tips
- > Compatible with tubes (0.2 mL to 50 mL) and microplates with up to 384 wells
- > Automatic exchange of two pipetting tools
- > Completely contained housing including door safety mechanism (except for 5070f, laminar-flow version)
- > Option for compact EasyCon tablet or MultiCon PC controller by touch, mouse or keyboard, upgradable for barcode tracking and GxP software versions

¹⁾ Patent US 6,819,437 B2



Applications

- > Serial dilutions
- > Distributing reagents
- > Assay set-up
- > Sample transfer from individual tubes to plates
- > Reformatting plates
- > (q) PCR set-up and normalization
- > Cell-based assay set-up
- > Immunoassay set-up
- > Setting concentrations or volumes
- > Media change, pooling and cherry picking

Special features for epMotion® 5070f

- > Eppendorf Light barrier beam – monitors the closure of the bench hood for safety
- > Pre-programmed cell culture labware
- > Sterile pipette tips available
- > Autoclavable pipetting tools

Your local distributor: www.eppendorf.com/contact

Eppendorf AG · Barkhausenweg 1 · 22339 Hamburg · Germany · eppendorf@eppendorf.com · www.eppendorf.com · www.eppendorf.com/eshop

epMotion® 5073l/5073m

**Product features**

- > 6 ANSI/SLAS microplate positions
- > Optical sensor¹⁾ for detecting liquids, labware, tips
- > Automatic replacement of 3 pipetting tools and gripper
- > Volume range of 0.2 to 1,000 µL for maximum pipetting accuracy
- > 3D-MagSep technology, mixing, tempering, and magnetic separation all at one location
- > Calibrated 1-channel and 8-channel pipetting tools
- > Optional UV lamp and HEPA filter system for decontamination and clean air conditions
- > Compatible with tubes (0.2 to 50 mL) and microplates with up to 384 wells

¹⁾ US patent 6,819,437 B2

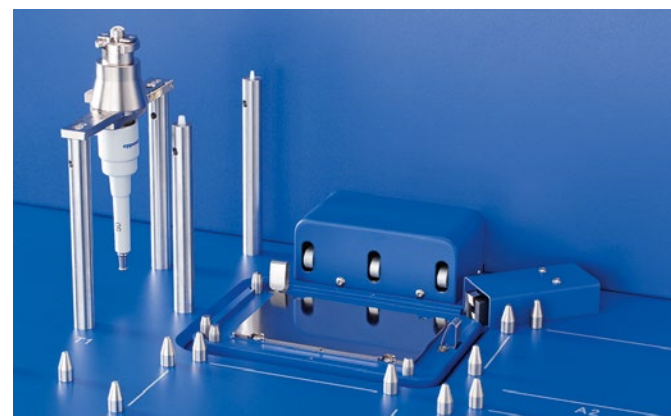
**Applications**

- > DNA and RNA purification
- > PCR set-up
- > Serial dilution and normalization of samples
- > Sample or reagent transfer
- > Sample mixing and tempering
- > Assay set-up
- > Nucleic acid extraction
- > Media change and other cell culture applications
- > Next Generation Sequencing library preparation with 5073m NGS solution

Special features for epMotion® 5073

- > The 6 positions of the epMotion® 5073 systems, automatic tool change, and gripper option open up a wide variety of applications
- > Unique combination of magnet finger module and Eppendorf ThermoMixer® allow you to separate, mixing and temper at one position (5073m)
- > Thermal module (optional) 5073l

For more information go to www.eppendorf.com

epMotion® 5075l

**Product features**

- > 15 ANSI/SLAS worktable positions
- > Maximum pipetting accuracy from 0.2 to 1,000 µL
- > Automatic exchange of all tools (gripper, 1-channel and 8-channel)
- > Optical sensor¹⁾ for detecting liquids, labware and tips
- > Compatible with tubes (0.2 mL to 50 mL) and microplates with up to 384 wells
- > Eppendorf MultiCon PC controller to run epBlue software by touch or mouse
- > Optional software extensions for handling samples with barcodes or for integration to LIMS and ELN
- > Optional software extensions for supporting regulated process environments (GLP, GMP, 21 CFR part 11)
- > CleanCap option – UV lamp and HEPA filter for decontamination and clean air conditions
- > 3 thermal module options for heating or cooling (0 – 110 °C) of samples or reagents

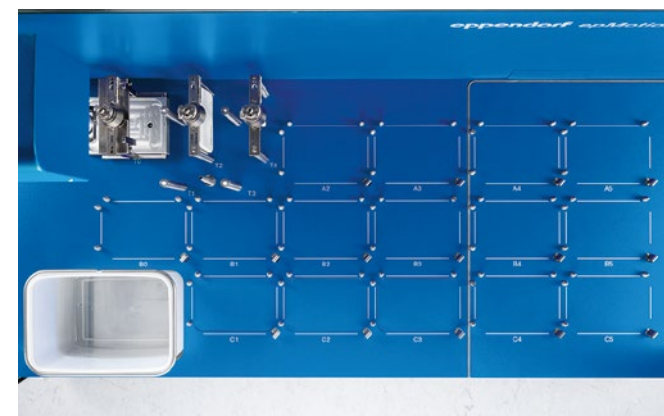
**Applications**

- > Next Generation Sequencing library preparation
- > Distributing reagents and serial dilutions
- > Sample transfer from individual tubes to plates
- > Reformatting plates
- > Media change and other cell culture applications
- > Sample pooling
- > Real-time PCR set-up
- > Cell-based assay set-up
- > Immunoassay set-up
- > Setting concentrations or volumes

epMotion® 5075t/5075m

**Product features**

- > Same as 5075i, plus
- > Integrated Eppendorf ThermoMixer® with ^{2D}Mix-Control technology
- > Temperature control range 15 °C below RT to 95 °C
- > Automatic fixing of labware for mixing up to 2,000 rpm
- > Pipetting at standard positions during shaking
- > 14.5 deck positions, 14 SLAS/ANSI plus small position for special reagent reservoir rack (3 reservoirs)
- > 2 thermal module options

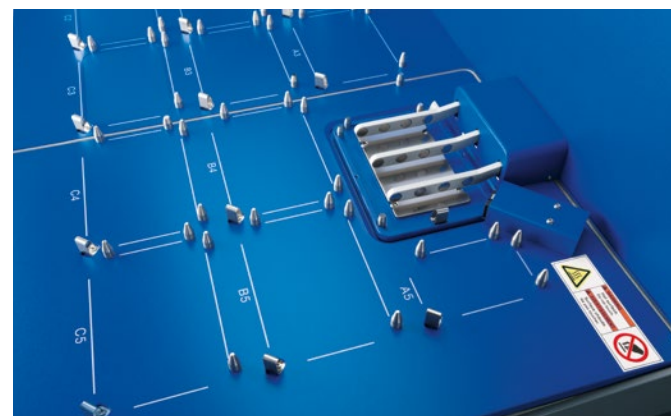
**Applications**

- > Like 5075i, plus
- > Bead applications with mixing and tempering
- > Sequencing and PCR clean-up
- > Nucleic acid purification
- > Cell disruption
- > Immunoassays
- > Next Generation Sequencing library preparation with 5075t NGS solution

Special features for epMotion® 5075m

- > Same as epMotion 5075t, plus
- > Combination of magnetic finger module and Eppendorf ThermoMixer®

For more information go to www.eppendorf.com

epMotion® 5075v/5075vt

**Product features**

- > Same as epMotion 5075i
- > 12 SLAS/ANSI deck positions
- > Integrated vacuum pump – silent operation, no tubing, wiring, or reservoirs to maintain
- > Vacuum station fully integrated that automatically adapts to filter plates controlled by software
- > Gripper for plate and labware transport
- > 3 thermal module options (2 in case of 5075vt)
- > Also available as 5075vt version with integrated Eppendorf ThermoMixer®

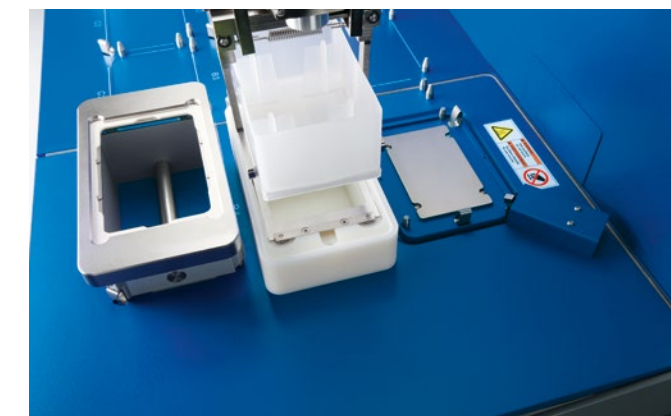
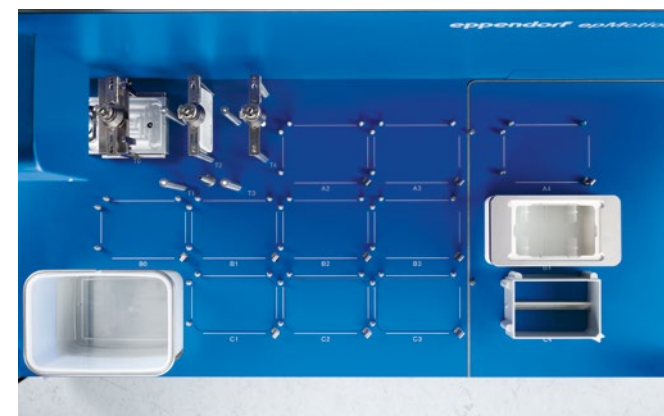
**Applications**

- > Like 5075i with vacuum purification technologies
- > Solid phase extraction
- > Filtration
- > DNA from blood, tissue and cells
- > DNA from plants and bacteria
- > Sequencing and PCR clean-up
- > Total RNA isolation

Special features for epMotion® 5075vt

- > Integrated Eppendorf ThermoMixer with ^{2D}Mix-Control technology
- > Temperature control range RT -15 °C to 95 °C
- > Automatic securing of labware for mixing up to 2,000 rpm

epMotion® 5073m NGS solution

Description

epMotion 5073m NGS solution contains everything you need to start your automated NGS library preparation. It combines automated liquid handling and unique software features with the accessories and high-quality consumables for reliable Next Generation Sequencing library preparation. The liquid handling robot has three dispensing tools, a gripper, a plate magnet, a TipHolder 73 and a Gripper Tower. The new Reservoir Rack Module NGS optimized for holding NGS reagents can be combined with the Reservoir Rack Module Tips to hold additional tips if needed. Furthermore, high-quality consumables and ep.T.I.P.S.® Motion 50 µL and 300 µL are part of the package. The epMotion 5073m is operated via EasyCon tablet or MultiCon Desktop PC, both equipped with Windows 10. Optionally, the epMotion can be connected to VisioNize® for runtime tracking, e-mail event notification and device monitoring. An intuitive software interface allows for ease-of-use and rapid method implementation, while providing the needed flexibility. An integrated magnetic finger and Eppendorf ThermoMixer® allow for upstream nucleic acid purification.

The pipetting robot is available with an optional CleanCap for UV light decontamination and a HEPA filter for clean and particle-free air inside the device. By automating NGS library preparation, you increase reproducibility and reduce pipetting errors and, in turn, improve your experimental data. You have time for data analysis or other laboratory tasks while epMotion takes over the tedious pipetting.

New



1. 6 ANSI/SLAS worktable positions
2. Compact control tablet with touchscreen or mouse operation, USB data transfer
3. Optical sensor¹⁾ for detecting liquids, labware, tips
4. Automatic replacement of 2 pipetting tools and gripper
5. Volume range of 0.2 to 1,000 µL for maximum pipetting accuracy
6. 3D-MagSep technology, mixing, tempering, and magnetic separation all at one location
7. Calibrated 1-channel and 8-channel pipetting tools
8. Optional UV lamp and HEPA filter system for decontamination and clean air conditions
9. Compatible with tubes (0.2 mL to 50 mL) and microplates with up to 384 wells

¹⁾ US patent 6,819,437 B2

Product features

- > Up to 24 samples for NGS library preparation with minimal user intervention
- > Three dispensing tools eliminate interruptions during NGS library preparation
- > TipHolder 73 and Gripper Tower allow the use of 5 x 96 tips on just two ANSI/SLAS positions
- > Reservoir Rack Module NGS offers storage of consumables, tips and reagents on one deck position
- > Magnetic fingers and a plate magnet together with ThermoMixer enable magnetic bead-based nucleic acid purification in plate or in tubes
- > MultiCon PC and EasyCon tablet work with Windows 10
- > Easier optimization by generating service reports in just a few clicks in epBlue software
- > Optional with MultiCon: Connect epMotion to VisioNize to monitor device status, runtime and get e-mail notifications

Applications

- > Next Generation Sequencing library preparation
- > NGS library quality control
- > Nucleic acid purification (magnetic bead-based)

Ordering information

Description	Order no.
New epMotion® 5073m EasyCon NGS solution, includes EasyCon and integrated Eppendorf ThermoMixer®, Enhanced feature set 1 software upgrade, dispensing tools (TS 50, TS 300, TM 300-8), NGS specific accessories, NGS specific consumables, 100 – 240 V ±10 %/50 – 60 Hz ±5 %, 0.2 µL – 1 mL	5073 000 930
New epMotion® 5073m MultiCon NGS solution, includes MultiCon PC and integrated Eppendorf ThermoMixer®, Enhanced feature set 1 software upgrade, dispensing tools (TS 50, TS 300, TM 300-8), NGS specific accessories, NGS specific consumables, 100 – 240 V ±10 %/50 – 60 Hz ±5 %, 0.2 µL – 1 mL	5073 000 949
New epMotion® 5073mc EasyCon NGS solution, includes EasyCon and integrated Eppendorf ThermoMixer®, with CleanCap, Enhanced feature set 1 software upgrade, dispensing tools (TS 50, TS 300, TM 300-8), NGS specific accessories, NGS specific consumables, 100 – 240 V ±10 %/50 – 60 Hz ±5 %, 0.2 µL – 1 mL	5073 000 957
New epMotion® 5073mc MultiCon NGS solution, includes MultiCon PC and integrated Eppendorf ThermoMixer®, with CleanCap, Enhanced feature set 1 software upgrade, dispensing tools (TS 50, TS 300, TM 300-8), NGS specific accessories, NGS specific consumables, 100 – 240 V ±10 %/50 – 60 Hz ±5 %, 0.2 µL – 1 mL	5073 000 965
epMotion® 5075t NGS solution, package with completely contained housing, MultiCon PC, Enhanced feature set 1, C2 thermal module, dispensing tools, plus NGS specific accessories, plus NGS specific consumables to start automated library preparation, 100 – 240 V ±10 %/50 – 60 Hz ±5 %, 0.2 µL – 1 mL	5075 000 962
epMotion® 5075tc NGS solution, package with CleanCap, MultiCon PC, Enhanced feature set 1, C2 thermal module, dispensing tools, plus NGS specific accessories, waste bag holder, plus NGS specific consumables to start automated library preparation, 100 – 240 V ±10 %/50 – 60 Hz ±5 %, 0.2 µL – 1 mL	5075 000 963

Ordering information

Description	Order no.
epMotion® 5070 EasyCon, completely contained housing, system incl. EasyCon, epBlue™ software, mouse, waste box, 100 – 240 V ±10 %/50 – 60 Hz ±5 %, 0.2 µL – 1 mL	5070 006 032
epMotion® 5070 MultiCon, completely contained housing, system incl. MultiCon, epBlue™ software, keyboard, mouse, waste box, 100 – 240 V ±10 %/50 – 60 Hz ±5 %, 0.2 µL – 1 mL	5070 000 282
epMotion® 5070f EasyCon, system incl. EasyCon, epBlue™ software, mouse, waste box, 100 – 240 V ±10 %/50 – 60 Hz ±5 %, 0.2 µL – 1 mL	5070 006 108
epMotion® 5070f MultiCon, system incl. MultiCon, epBlue™ software, keyboard, mouse, waste box, 100 – 240 V ±10 %/50 – 60 Hz ±5 %, 0.2 µL – 1 mL	5070 000 283
epMotion® 5073l EasyCon, completely contained housing system incl. EasyCon, epBlue™ software, mouse, waste box, 100 – 240 V ±10 %/50 – 60 Hz ±5 %, 0.2 µL – 1 mL	5073 000 582
epMotion® 5073l MultiCon, completely contained housing system incl. MultiCon, epBlue™ software, keyboard, mouse, waste box, 100 – 240 V ±10 %/50 – 60 Hz ±5 %, 0.2 µL – 1 mL	5073 000 590
epMotion® 5073lc EasyCon, CleanCap, system incl. EasyCon, epBlue™ software, mouse, waste box, 100 – 240 V ±10 %/50 – 60 Hz ±5 %, 0.2 µL – 1 mL	5073 000 604
epMotion® 5073lc MultiCon, CleanCap, system incl. MultiCon, epBlue™ software, keyboard, mouse, waste box, 100 – 240 V ±10 %/50 – 60 Hz ±5 %, 0.2 µL – 1 mL	5073 000 612
epMotion® 5075l, basic device incl. epBlue™ software, mouse, waste box, 100 – 240 V ±10 %/50 – 60 Hz ±5 %, 0.2 µL – 1 mL	5075 000 301
epMotion® 5075v, basic device incl. vacuum system, gripper, vac frame 2, vac frame holder, epBlue™ software, mouse, waste box, 100 – 240 V ±10 %/50 – 60 Hz ±5 %, 0.2 µL – 1 mL	5075 000 303
epMotion® 5075t, basic device incl. Eppendorf ThermoMixer®, epBlue™ software, mouse, waste box, 100 – 240 V ±10 %/50 – 60 Hz ±5 %, 0.2 µL – 1 mL	5075 000 302
epMotion® 5075vt, basic device incl. vacuum system, gripper, vac frame 2, vac frame holder, Eppendorf ThermoMixer®, epBlue™ software, mouse, waste box, 100 – 240 V ±10 %/50 – 60 Hz ±5 %, 0.2 µL – 1 mL	5075 000 304
epMotion® 5075m, basic device incl. Eppendorf MagSep™ module, Eppendorf ThermoMixer®, epBlue™ software, mouse, waste box, 100 – 240 V ±10 %/50 – 60 Hz ±5 %, 0.2 µL – 1 mL	5075 000 305

✎ Ordering information for other voltage options begins on page 450



epT.I.P.S.[®] Motion as Reload System

Description

epT.I.P.S. Motion can be used with epMotion[®] 96 or integrated into your workstation as a reload system when combined with the tip holder. The high-quality reload tips are delivered in a PET thermoformed tray with sealed lid. Upgrading to the autoclavable, aluminum tip holder, which replaces the disposable box, provides waste reduction of up to 40 %.



Product features

- > Delivered in a PET blister packaging with a sealed cap to assure quality
- > Color coded trays for easy volume identification
- > Reload system with autoclavable aluminum tip holder reduces plastic waste of tip boxes by up to 40 %
- > Available with standard and filter/PCR clean tips

Applications

- > Easy conversion with TipHolder Adapter
- > TipHolder Adapter is autoclavable

Ordering information

Description	Order no.
epT.I.P.S.[®] Motion as Reload System, without filter	
Eppendorf Quality [™] , 10 µL, 2,304 tips (24 trays × 96 tips)	0030 014 545
Eppendorf Quality [™] , 50 µL, 2,304 tips (24 trays × 96 tips)	0030 014 421
Eppendorf Quality [™] , 300 µL, 2,304 tips (24 trays × 96 tips)	0030 014 464
Eppendorf Quality [™] , 1,000 µL, 2,304 tips (24 trays × 96 tips)	0030 014 502
epT.I.P.S.[®] Motion as Reload System, with filter	
PCR clean, 10 µL, 2,304 tips (24 trays × 96 tips)	0030 014 553
PCR clean, 50 µL, 2,304 tips (24 trays × 96 tips)	0030 014 430
PCR clean, 300 µL, 2,304 tips (24 trays × 96 tips)	0030 014 472
PCR clean, 1,000 µL, 2,304 tips (24 trays × 96 tips)	0030 014 510
PCR clean and sterile, 10 µL, 2,304 tips (24 trays × 96 tips)	0030 014 561
PCR clean and sterile, 50 µL, 2,304 tips (24 trays × 96 tips)	0030 014 529
PCR clean and sterile, 300 µL, 2,304 tips (24 trays × 96 tips)	0030 014 537
TipHolder, for epT.I.P.S.[®] Motion Reloads	5075 751 399

For more information go to www.eppendorf.com

epT.I.P.S.[®] Motion pipette tips

Description

Automated pipetting processes place high demands on the design and material of pipette tips used. Eppendorf has specially designed the epT.I.P.S. Motion for use on the epMotion[®] 5070, 5073 and 5075 Liquid Handling Workstation. epT.I.P.S. Motion pipette tips, with and without filters, developed in torsion-resistant, clean racks.



Product features

- > Color-coded trays for direct volume identification
- > O-ring on dispensing tools assures an optimal fit each time
- > Optical sensor automatically identified tip type

Applications

- > Available in multiple purity grades
- > Easily exchangeable, no additional labware files required
- > Also available as reload system
- > Also available as epT.I.P.S. Motion SafeRacks recommended for re-use tips feature

Ordering information

Description	Order no.
epT.I.P.S.[®] Motion pipette tips, without filter	
Sterile, 10 µL, 960 tips (10 racks × 96 tips)	0030 015 185
Sterile, 50 µL, 960 tips (10 racks × 96 tips)	0030 015 207
Sterile, 300 µL, 960 tips (10 racks × 96 tips)	0030 015 223
Sterile, 1,000 µL, 960 tips (10 racks × 96 tips)	0030 015 240
Eppendorf Quality [™] , 10 µL, 960 tips (10 racks × 96 tips)	0030 014 383
Eppendorf Quality [™] , 50 µL, 960 tips (10 racks × 96 tips)	0030 014 405
Eppendorf Quality [™] , 300 µL, 960 tips (10 racks × 96 tips)	0030 014 448
Eppendorf Quality [™] , 1,000 µL, 960 tips (10 racks × 96 tips)	0030 014 480
epT.I.P.S.[®] Motion pipette tips, with filter	
PCR clean and sterile, 10 µL, 960 tips (10 racks × 96 tips)	0030 015 193
PCR clean and sterile, 50 µL, 960 tips (10 racks × 96 tips)	0030 015 215
PCR clean and sterile, 300 µL, 960 tips (10 racks × 96 tips)	0030 015 231
PCR clean and sterile, 1,000 µL, 960 tips (10 racks × 96 tips)	0030 015 258
PCR clean, 10 µL, 960 tips (10 racks × 96 tips)	0030 014 391
PCR clean, 50 µL, 960 tips (10 racks × 96 tips)	0030 014 413
PCR clean, 300 µL, 960 tips (10 racks × 96 tips)	0030 014 456
PCR clean, 1,000 µL, 960 tips (10 racks × 96 tips)	0030 014 499
epT.I.P.S.[®] Motion as SafeRack tips, without filter	
Eppendorf Quality [™] , 50 µL, 960 tips (10 racks × 96 tips)	0030 014 600
Eppendorf Quality [™] , 300 µL, 960 tips (10 racks × 96 tips)	0030 014 626
Eppendorf Quality [™] , 1,000 µL, 960 tips (10 racks × 96 tips)	0030 014 642
epT.I.P.S.[®] Motion as SafeRack tips, with filter	
PCR clean, 50 µL, 960 tips (10 racks × 96 tips)	0030 014 618
PCR clean, 300 µL, 960 tips (10 racks × 96 tips)	0030 014 634
PCR clean, 1,000 µL, 960 tips (10 racks × 96 tips)	0030 014 650

Software

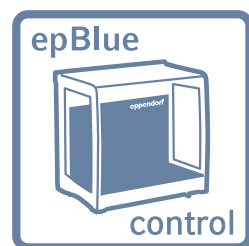
**epBlue™ epMotion® PC software**

- > Graphical user interface
- > Main menu with direct access to the most important functions
- > 3D view of workstation and run simulation
- > User administration with password protection
- > Importing of files for normalization and cherry picking
- > Printing and archiving protocols
- > Pre-installed on all epMotion systems
- > Create, edit and simulate application on any Windows 7, 8 or 10 PC with epMotion Editor 40 software product

**epBlue™ ID software**

- > Visual tracking of the scan procedure
- > Automatic checking of the worktable
- > Scanning of individual reaction vessels and microplates
- > Documentation of reagent type and batch
- > CSV or XML-based results file
- > Compatible with LIMS-generated work lists
- > Data exchange with 2D barcode readers
- > Easy to operate

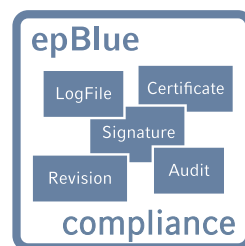
**epBlue™ GxP software**

- > Complete electronic documentation
- > Access control and user level management
- > Audit trail and log file
- > Revision management
- > Electronic signatures
- > Electronic certificates according to industry-standard algorithm
- > Exporting and archiving of digitally signed documents
- > Database system
- > Supplied certificates
- > Expansion via epBlue ID (optional)

Detailed information about the automation software can be found here: www.ependorf.com/epBlue



Device Hardware Upgrades and Software

Ordering information

Description	Order no.
Thermal module , thermal module for heating or cooling (0 – 100 °C) thermo adaptors, thermoblock and thermoracks	5075 757 001
VAC , for retrofitting a 5075 LH version into a VAC version	5075 000 610
Panel plate , for control panel rest, mounted at front left side of epMotion® unit	5075 798 000
Work surface adapter , for raising the epMotion® worktable by 5.5 cm, 4 feet	5070 752 001
epBlue™ ID barcode and tracking software incl. manual barcode scanner , modular expansion of epBlue™ for barcode support. Incl. manual barcode reader with stand. Compatible with epBlue™ version 40.1 and higher	5075 002 701
epBlue™ ID software and hardware modification kit , for 5070 and 5075 PC versions (SN < 4000), barcode support includes software, barcode reader and stand, compatible with all epMotion® PC versions except epMotion® 5075 MC PC version, not compatible with the epMotion® operator panel or EasyCon versions	5075 000 830
epBlue™ GxP software , for use in supporting process environments (according to GLP, GMP, 21 CFR part 11), as configuration option or for pre-installed epMotion® MultiCon versions with epBlue™ version 40.1 to 40.5, with epBlue™ GxP software, corresponding firmware, certificates	5075 002 728

i For more information go to www.ependorf.com

Technical specifications subject to change.

Ordering information

Description	Order no.
epMotion® Editor , incl. editor key, software package for creating and editing applications, runs on the PC, compatible with epBlue™ 10.x versions	5075 014 009
epMotion® Editor , incl. editor key, for creating and editing applications, runs on the PC, compatible with epBlue™ 10.x versions additional license	5075 015 200
epMotion® Editor 40 , software CD ROM with instructions, used to create, edit and simulate application on a PC, compatible with epBlue™ version >40.x	5075 014 220
epMotion® Editor 40 , additional software license	5075 014 300
Enhanced Feature Set 1 , license for epBlue™ additional features: Calculated , samples; Automatic tool selection; Start at command; Email notification, requires service visit and epBlue >40.6	5075 000 964

Dispensing tools

**Description**

Highly precise pipetting heads, for use in the tool holder of the epMotion workstation. Each dispensing tool is completely autoclavable at 121 °C, 1 bar for 20 min. A quality certificate for the measurement results accompanies each tool.

Product features

- > Highest accuracy from 200 nL to 1,000 µL
- > For various types of liquids
- > 1- and 8-channel dispensing tools

Ordering information

Description	Order no.
TS 10 single channel dispensing tool , single-channel, 0.2 – 10 µL	5280 000 100
TS 50 single-channel dispensing tool , single-channel, 1.0 – 50 µL	5280 000 010
TS 300 single-channel dispensing tool , single-channel, 20 – 300 µL	5280 000 037
TS 1000 single-channel dispensing tool , single-channel, 40 – 1,000 µL	5280 000 053
TM 10-8 eight-channel dispensing tool , multi-channel, 0.2 – 10 µL	5280 000 304
TM 50-8 eight-channel dispensing tool , multi-channel, 1.0 – 50 µL	5280 000 215
TM 300-8 eight-channel dispensing tool , multi-channel, 20 – 300 µL	5280 000 231
TM 1000-8 eight-channel dispensing tool , multi-channel, 40 – 1,000 µL	5280 000 258
Holder for 6 dispensing tools	5075 774 003

Your local distributor: www.ependorf.com/contact

Eppendorf AG · Barkhausenweg 1 · 22339 Hamburg · Germany · eppendorf@ependorf.com · www.ependorf.com · www.ependorf.com/eshop



epMotion® ReservoirRacks and Modules



Description

The Eppendorf Reservoirs are the perfect vessels for the provision of 10 to 400 mL liquid, and they permit the use of single channel and multichannel dispensing tools. The tapered shape of the reservoirs allows utilization of the entire liquid volume with minimal residue. Moreover, the reservoirs may be temperature-controlled inside the racks to allow cooling or warming of liquids, for example, when PCR-mastermixes or cell culture media are used. Our Reservoir Racks hold reaction vessels of different sizes, and they are tempered in order to protect valuable samples or carry out reactions directly inside the Reservoir Rack.

Ordering information

Description	Order no.
ReservoirRack , for presenting 10 mL, 30 mL and 100 mL reagent reservoirs. Up to 7 reservoirs or Reservoir Rack modules can be presented.	5075 754 002
Adapter sleeves , to retrofit the 1.5/2.0 mL thermoracks for use with 0.5 mL vessels, 1 set of 25 pieces	5075 772 000
Gripper Tower , enables positioning epT.I.P.S.® Motion Reload trays in the parking position of the gripper and holds the gripper when it is not in use; only for use with epMotion® 5073 as of serial number 6000	5075 751 895
Reservoir Rack Module NGS , for use with epMotion® ReservoirRacks, for distributing samples and reagents for NGS-specific applications, space for 20 x ILMN tubes, 4 x Eppendorf Tubes® 5.0 mL, 4 x Eppendorf Tubes 1.5 mL	5075 751 917
Reservoir Rack Module PCR , for use with epMotion® ReservoirRacks, for distributing samples and reagents for PCR, space for 48 x PCR tubes 0.2 mL incl. 2 x strip adapters 0.2 mL, (alternatively, space sufficient for 16 index tubes and up to 32 x PCR tubes 0.2 mL), 12 x Eppendorf Tubes 1.5/2.0 mL, 1 x tube 5.0 mL	5075 751 933
Reservoir Rack Module Tips , for use with epMotion® ReservoirRacks, for providing up to 16 epT.I.P.S.® Motion per module and up to 7 modules per ReservoirRack (112 tips in total), set consisting of 7 modules	5075 751 950
TipHolder , for epT.I.P.S.® Motion Reloads	5075 751 399
TipHolder 73 , enables positioning epT.I.P.S.® Motion Reload trays above a rack of epT.I.P.S.® Motion and thus doubles the tip capacity in an ANSI/SLAS position, reusable and autoclavable, epBlue 40.7 or higher required	5075 751 879
ReservoirRack Module TC , for use in epMotion® ReservoirRacks, temperable, 8 x PCR tubes 0.2 mL	5075 799 049
ReservoirRack Module TC , for use in epMotion® ReservoirRacks, temperable, 4 x Safe-Lock tubes 0.5/1.5/2.0 mL	5075 799 081
ReservoirRack Module TC , for use in epMotion® ReservoirRacks, temperable, 4 x Eppendorf Tubes® 5.0 mL	5075 799 340
ReservoirRack Module TC , for use in epMotion® ReservoirRacks, temperable, 4 x reaction vessels Ø 12 mm	5075 799 103
ReservoirRack Module TC , for use in epMotion® ReservoirRacks, temperable, 4 x reaction vessels Ø 16 mm	5075 799 120
ReservoirRack Module TC , for use in epMotion® ReservoirRacks, temperable, 4 x reaction vessels Ø 17 mm	5075 799 162
ReservoirRack Module TC , for use in epMotion® ReservoirRacks, temperable, 2 x reaction vessels Ø 29 mm	5075 799 189
ReservoirRack Module TC , for use in epMotion® ReservoirRacks, temperable, 1 x reservoir 10 mL	5075 799 421
ReservoirRack Module TC , for use in epMotion® ReservoirRacks, temperable, 1 x reservoir 30 mL	5075 799 146
ReservoirRack Module TC , for use in epMotion® ReservoirRacks, temperable, 1 x reservoir 100 mL	5075 799 260
epMotion® reservoir 10 mL , small-volume container for reagent presentation on the epMotion®, can only be inserted with the Reservoir Rack; production batch testing, certified, 10 mL, 10 x 5 reservoirs in the bag, PCR clean, polypropylene	0030 126 521
epMotion® reservoir 30 mL , large-volume container for reagent presentation on the epMotion®, can only be inserted with the Reservoir Rack; production batch testing, certified, 30 mL, 10 x 5 reservoirs in the bag, PCR clean, polypropylene	0030 126 505
epMotion® reservoir 100 mL , large-volume container for reagent presentation on the epMotion®, can only be inserted with the Reservoir Rack; production batch testing, certified, 100 mL, 10 x 5 reservoirs in the bag, PCR clean, polypropylene	0030 126 513
epMotion® reservoir 400 mL , large-volume container for reagent presentation on the epMotion®; production batch testing, certified, 400 mL, 10 reservoirs, PCR clean, autoclavable, polypropylene	5075 751 364
epMotion® reservoir 195 mL , low dead volume reservoir, single well with 96 cavities, PCR clean, 4 x 5 reservoirs	0030 126 556

For more information go to www.eppendorf.com

Technical specifications subject to change.



epMotion® Thermoracks and Plate Accessories

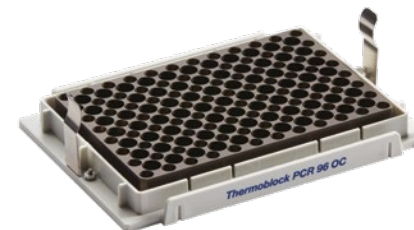

Description

The Thermoracks, Thermoblocks and Thermo adapters comprise versatile options for the cooling or warming of reaction vessels and plates of different formats. In addition, a gripper for plates and racks is capable of reducing, or even eliminating, interference within the workflow. A magnet adapter for the purification of DNA/RNA using magnetic beads is also available, and it enables fully automated purification using a diverse range of kits.

Ordering information

Description	Order no.
Thermorack CB , for up to 384 x 0.1 mL strip tubes in the Qiagen® Rotor-Gene®	5075 767 031
Eppendorf Magnum FLX® Magnet Adapter , universal ring magnet plate for rapid magnetic bead separation. Supports most 96-well plates (standard, PCR, deepwell)	5075 751 836
Thermorack Rotor/Tubes , for temperature controlled pipetting of Qiagen® Rotor-Disc® 72/100 and 20 tubes 1.5/2.0 mL	5075 751 526
Thermoblock PCR 96 OC , for temperature control and safe piercing of sealed, semi-skirted PCR plates with orientation control	5075 751 666
Thermoadapter for PCR , for temperature control of PCR plates, 96 wells, skirted	5075 787 008
Thermoadapter for PCR , for temperature control of PCR plates, 384 wells, skirted	5075 788 004
Thermoadapter Frosty , combination of height adapter and PCR-Cooler, for cooling skirted PCR plates	5075 789 000
CycleLock Starter Set , 1 frame and 8 mats for automated sealing of Eppendorf PCR plates, can only be used with Mastercycler® ep, PCR clean	0030 126 530
CycleLock mats , 5 sealing mats, frame not included, PCR clean	0030 126 548
Lid for Thermorack Rotor/Tubes , with adapter for placing the lid on the epMotion® worktable	5075 751 640
Thermoblock DWP 2000 , for 2 mL Eppendorf Deepwell Plates 96/2000	5075 751 330
Thermoadapter DWP 96 , for Deepwell Plates 96/1000	5075 751 054
Thermoadapter LC Sample , for MagNA Pure LC sample cartridge	5075 751 305
Thermorack , for 24 Safe-Lock tubes, temperable, 0.5/1.5/2.0 mL	5075 769 000
Thermorack , for 24 Safe-Lock tubes, temperable, 1.5/2.0 mL	5075 771 004
Thermorack TMX , for 24 Safe-Lock micro test tubes, 0.5 mL/1.5 mL/2.0 mL	5075 751 160
Thermorack TMX , for 24 Safe-Lock tubes, temperable, 1.5/2.0 mL	5075 751 186
Thermorack , for 24 Cryo tubes	5075 777 055
Elution plate adapter , for processing micro tubes in racks	5075 785 030
Thermoblock for PCR , for temperature control of 96 vessels 0.2 mL, 77 PCR tubes 0.5 mL or one PCR plate 96 wells, semi-skirted	5075 766 000
Thermoblock for PCR , for temperature control of PCR plate 384 wells, semi-skirted	5075 767 007
Thermoadapter for Microplate 96/V/U , for holding and temperature control of Eppendorf Microplates with V or U bottom	5075 751 577
Gripper , incl. holder, for transporting plates on the worktable and automatic operation of the vacuum manifold	5282 000 018
TMX , for retrofitting a 5075 LH version into a 5075 TMX version	5075 000 628

epMotion® 96 Accessories



Description

The accessories for the epMotion 96 and epMotion 96xl increase the capacity for plates and reservoirs. Furthermore, tip trays, as well as an adapter for easy handling of 384 well plates, are also available.

Ordering information

Description	Order no.
epMotion® 96 Accessories , Loading frame for epMotion® 96	5069 072 005
epMotion® 96 Accessories , Adapter 384-well plate for epMotion® 96	5069 073 001
epMotion® 96 Accessories , Upgrade set 2-position slider for epMotion® 96	5069 074 008

Your local distributor: www.eppendorf.com/contact

Eppendorf AG · Barkhausenweg 1 · 22339 Hamburg · Germany · eppendorf@eppendorf.com · www.eppendorf.com · www.eppendorf.com/eshop



epMotion® Tuberacks, Adapters and Vacuum Modules



Description

Tube racks are specially designed for the respective dimensions of the reaction vessels, and they thus provide optimal support for plastic as well as glass vessels.

Ordering information

Description	Order no.
PrepRack for 24 Eppendorf Safe-Lock Tubes 2 mL , for nucleic acid preparation	5073 751 006
Rack Smart , for holding one tube rack of SmartCycler™ reaction tubes	5075 790 009
Rack LC 20 µL/100 µL , for up to 96 × 20 µL or 100 µL LightCycler capillaries for use with Centrifuge 5804/5804 R or 5810/5810 R and other devices, set of 2	5075 795 000
Rack ILMN tubes , Rack for single tubes, 40 × ø 8.4 mm and 12 × ø 11.2 mm, transportable, autoclavable	5075 751 747
Rack for single test tubes , for presenting Eppendorf reaction vessels, glass or plastic tubes, not temperable	
Ø 17 mm × 100 mm max. length	5075 761 009
Ø 17 mm × 60 mm max. length	5075 775 000
Ø 16 mm × 100 mm max. length	5075 760 002
Ø 16 mm × 60 mm max. length	5075 776 006
Ø 15 mm × 100 mm max. length	5075 792 028
Ø 15 mm × 60 mm max. length	5075 792 044
Ø 14 mm × 100 mm max. length	5075 792 001
Ø 14 mm × 60 mm max. length	5075 792 060
Ø 13 mm × 100 mm max. length	5075 762 005
Ø 13 mm × 60 mm max. length	5075 792 087
Ø 12 mm × 100 mm max. length	5075 763 001
Ø 12 mm × 60 mm max. length	5075 792 109
Rack , for 24 HPLC tubes, Ø 12 mm × 40 mm max. length	5075 792 125
Rack , for 96 screw cap tubes, 1.5/2.0 mL	5075 791 005
Rack for 24 tubes , for 24 Safe-Lock tubes, no tempering	
0.5/1.5/2.0 mL	5075 751 453
1.5/2.0 mL	5075 751 275
Holder for Vac Frame	5075 778 009
Vacuum lid	5075 779 005
Mat for vacuum lid	5075 793 008
Vac Frame 1 , 16 mm height, recommended for filter plates from 5Prime, Invitex	5075 784 009
Vac Frame 2 , 26 mm height, recommended for filter plates from MN, Promega or Qiagen	5075 785 005
Anticontamination plate adapter , for vacuum processes with foaming solutions in multiwell plates, set of 10	5075 794 004
Vac Thermo lid	5075 796 007
Collection plate adapter MN , type for VAC station	5075 785 064
TMX expansion board VAC , order with 5075 000 628	5075 000 636



epMotion® Waste Accessories



Description

During the pipetting of liquids, waste, both liquid and solid, are generated. Solid waste mainly consists of pipette tips and reaction vessels. In order to dispose of both types of waste correctly, we offer variable options for collecting solid waste in bags or boxes, and for collecting liquid waste in a specialized reservoir which can then be properly discarded. In order to use garbage bags of larger capacity inside an epMotion Workstation, it will be necessary to elevate the Workstation slightly by using a work surface adapter (5070 752 001).

Ordering information

Description	Order no.
Waste bag holder , for epMotion® 5070/5073/5075 waste position	5075 753 103
Liquid Waste Tub 400 mL , to mount in waste bag holder and waste container of epMotion®, with lid, autoclavable, working volume 400 mL	5075 751 720
Liquid Waste Tub, incl. lid , to mount in the waste box, autoclavable, working volume 115 mL	5075 751 500
Waste container with ring , for holding used pipette tips	5075 753 006
Waste bags bio. , for epMotion® 5070/5073/5075 waste position, up to 7 L volume, ideal for disposing of biologically hazardous waste, autoclavable, PP material, thickness 50 µm, transparent, 50 bags	5075 751 763
Waste bags , for epMotion® 5070/5073/5075 waste position, up to 7 L volume, ideal for disposing of non hazardous waste, autoclavable, PP material, thickness 50 µm, transparent, 50 bags	5075 751 780

epMotion® Height adapters



Description

For the optimization of workflow processes, it may become necessary to adjust the heights of all the vessels used (tip racks, plates and reservoir racks) to the same level in order to minimize vertical traveling distances as well as save time. Our height adapters are the ideal solution that will bring your work table to one level.

Ordering information

Description	Order no.
epMotion® height adapter , for leveling labware, enables faster plate processing	
85 mm	5075 751 003
55 mm	5075 752 000
40 mm, for pipette tips	5075 755 009

Sample Handling



Model	Eppendorf ThermoMixer® C	Eppendorf ThermoStat™ C	Eppendorf ThermoMixer® F0.5
Page(s)	110	112	116
Heating rate	Max. 7 °C/min (when using SmartBlock plates) ¹⁾	Max. 9 °C/min (when using the SmartBlock PCR 384) ¹⁾	Max. 15 °C/min
Cooling rate	Max. 2.5 °C/min between 100 °C and RT	Max. 5.0 °C/min between 110 °C and RT ¹⁾	–
Timer	15 sec to 99:30 h, continuous	15 s to 99:30 h, continuous	–
Mixing and vortexing radius	1.5 mm	–	1.5 mm
Mixing orbit	3 mm	–	3 mm
Mixing frequency	300 – 3,000 rpm ¹⁾	–	300 – 2,000 rpm
Max. speed	3,000 rpm ¹⁾	–	2,000 rpm
Temperature settings	1 °C / 100 °C	–10 °C / 110 °C (110 °C when using the SmartBlocks 12 mm or cryo)	1 °C / 100 °C
Temperature range	Min: 15 °C (depends on SmartBlock used) below RT, max: 100 °C	Min: 30 °C ¹⁾ below RT, max: 110 °C (110 °C when using the 12 mm and cryo SmartBlocks)	Min: 4 °C above RT, max: 100 °C
Temperature accuracy	Max. ±0.5 °C at 20 – 45 °C	Max. ±0.5 °C at 20 – 45 °C ¹⁾	Max. ±0.5 °C at 20 – 45 °C
Interfaces	USB interface	USB interface	USB interface
Dimensions (W x D x H)	20.6 x 30.4 x 13.6 cm	20.6 x 30.4 x 13.6 cm	20.6 x 30.4 x 16.3 cm
Weight w/o accessories	6.3 kg	4.3 kg	6.2 kg
Power supply	100 – 130 V/220 – 240 V, 50 – 60 Hz	100 – 130 V/220 – 240 V, 50 – 60 Hz	100 – 130 V/220 – 240 V, 50 – 60 Hz
Max. power consumption	200 W	200 W	200 W
Applications	<ul style="list-style-type: none"> > Plasmid/RNA/DNA purification > cDNA synthesis > Extraction of DNA fragments from agarose gels > Enzymatic reactions (e.g., DNA restriction digestion, Proteinase K digestion and ligation) > Transformation of bacteria strains and plasmids > Denaturation of DNA, RNA, and proteins > Labeling of DNA, RNA, and proteins > Bacterial growth in microreaction vessels, conical tubes, and Deepwell Plates > Lysis reactions at 100 °C > Mixing of PCR setups 	<ul style="list-style-type: none"> > Gentle thawing and cooling buffers and samples at low temperatures > Preheating media > Biochemical reactions at low temperatures > Ligation > cDNA synthesis > Denaturation of RNA, DNA, and protein > Proteinase K digestion > ELISA assays > Immunoprecipitation > Cell lysis 	<ul style="list-style-type: none"> > Growth of bacteria and yeasts > Enzymatic reactions > Transformation of bacteria strains and plasmids > Denaturation of DNA, RNA, and proteins > Lysis reactions at 100 °C > Labeling of nucleic acids and proteins > Proteinase K digestion of cells and tissues > Resuspension of pellets > Mixing protein quantification assays > ELISA assays

¹⁾ depends on SmartBlock used

Model	Eppendorf ThermoMixer® F1.5	Eppendorf ThermoMixer® F2.0	Eppendorf ThermoMixer® FP	MixMate®
Page(s)	116	116	116	117
Heating rate	Max. 11 °C/min	Max. 13 °C/min	Max. 18 °C/min	–
Cooling rate	–	–	–	–
Timer	–	–	–	–
Mixing and vortexing radius	1.5 mm	1.5 mm	1.5 mm	1.5 mm
Mixing orbit	3 mm	3 mm	3 mm	3 mm
Mixing frequency	300 – 1,500 rpm	300 – 1,500 rpm	300 – 2,000 rpm	300 – 3,000 rpm
Max. speed	1,500 rpm	1,500 rpm	2,000 rpm	3,000 rpm
Temperature settings	1 °C / 100 °C	1 °C / 100 °C	1 °C / 100 °C	–
Temperature range	Min: 4 °C above RT, max: 100 °C	Min: 4 °C above RT, max: 100 °C	Min: 4 °C above RT, max: 100 °C	N/A
Temperature accuracy	Max. ±0.5 °C at 20 – 45 °C	Max. ±0.5 °C at 20 – 45 °C	Max. ±0.5 °C at 20 – 45 °C	–
Interfaces	USB interface	USB interface	USB interface	–
Dimensions (W x D x H)	20.6 x 30.4 x 17.0 cm	20.6 x 30.4 x 17.0 cm	20.6 x 30.4 x 16.4 cm	17 x 23 x 13 cm
Weight w/o accessories	6.3 kg	6.3 kg	6.1 kg	4.2 kg
Power supply	100 – 130 V/220 – 240 V, 50 – 60 Hz	100 – 130 V/220 – 240 V, 50 – 60 Hz	100 – 130 V/220 – 240 V, 50 – 60 Hz	110 – 120 V/220 – 240 V, 50 – 60 Hz
Max. power consumption	200 W	200 W	200 W	40 W
Applications	<ul style="list-style-type: none"> > Growth of bacteria and yeasts > Enzymatic reactions > Transformation of bacteria strains and plasmids > Denaturation of DNA, RNA, and proteins > Lysis reactions at 100 °C > Labeling of nucleic acids and proteins > Proteinase K digestion of cells and tissues > Resuspension of pellets > Mixing protein quantification assays > ELISA assays 	<ul style="list-style-type: none"> > Growth of bacteria and yeasts > Enzymatic reactions > Transformation of bacteria strains and plasmids > Denaturation of DNA, RNA, and proteins > Lysis reactions at 100 °C > Labeling of nucleic acids and proteins > Proteinase K digestion of cells and tissues > Resuspension of pellets > Mixing protein quantification assays > ELISA assays 	<ul style="list-style-type: none"> > Growth of bacteria and yeasts > Enzymatic reactions > Transformation of bacteria strains and plasmids > Denaturation of DNA, RNA, and proteins > Lysis reactions at 100 °C > Labeling of nucleic acids and proteins > Proteinase K digestion of cells and tissues > Resuspension of pellets > Mixing protein quantification assays > ELISA assays 	<ul style="list-style-type: none"> > Resuspending pellets (e.g., bacteria, DNA, cell culture pellets) > Mixing PCR setups > Mixing viscous liquids and suspensions (incl. beads) > Mixing restriction digestions > Immunoassays (e.g., ELISA) > Colorimetric assays (e.g., Bradford, Lowry, BCA) > Reporter gene assays (e.g. β-galactosidase, luciferase) > Vortexing numerous tube formats (e.g., 15 and 50 mL conical tubes)

i For more information go to www.eppendorf.com/temperaturecontrol-mixing



Technical specifications subject to change.



On page 384 you will find detailed information on services for these products!

Your local distributor: www.eppendorf.com/contact
Eppendorf AG · Barkhausenweg 1 · 22339 Hamburg · Germany · eppendorf@eppendorf.com · www.eppendorf.com · www.eppendorf.com/eshop



Sample Handling



Model	Tube 3810X	Safe-Lock Tube 0.5 mL	Safe-Lock Tube 1.5 mL	Safe-Lock Tube 2.0 mL
Page(s)	121	122	122	122
Volume	1.5 mL	0.5 mL	1.5 mL	2.0 mL
Bottom shape	conical	conical	conical	round
Max. RCF Eppendorf Quality™	30,000 × g	30,000 × g	30,000 × g	25,000 × g
Max. RCF PCR clean	30,000 × g	30,000 × g	30,000 × g	25,000 × g
Max. RCF Biopur®	-	22,000 × g	22,000 × g	22,000 × g
Max. RCF Sterile	-	-	-	-
Light protection	no	yes	yes	yes

¹⁾ Test conditions: Rotor FA-45-6-30 in Eppendorf Centrifuge 5810 R (using a suitable centrifuge adapter for 15 mL tube), sample: saline solution (density: 1.0 g/mL), controlled centrifugation temp.: 25 °C, centrifugation time: 90 min



Eppendorf Tubes® 5.0 mL	Eppendorf Conical Tubes 15 mL	25 mL, snap cap/25 mL, screw cap	Eppendorf Conical Tubes 50 mL
124	128	126	128
5.0 mL	15 mL	25 mL	50 mL
conical	conical	conical	conical
25,000 × g	-	-	-
25,000 × g	-	-	-
25,000 × g	-	-	-
25,000 × g	19,500 × g ¹⁾	up to 17,000 × g ¹⁾	19,500 × g ¹⁾
yes	yes	yes	yes

New



Model	Protein LoBind Tubes/ DNA LoBind, 0.5 mL	Protein LoBind Tubes/ DNA LoBind, 1.5 mL	Protein LoBind Tubes/ DNA LoBind, 2.0 mL
Page(s)	137/139	137/139	137/139
Bottom shape	conical	conical	round
Max. RCF PCR clean	18,000 × g/ 30,000 × g	18,000 × g/ 30,000 × g	18,000 × g/ 25,000 × g



Protein LoBind Tubes/ DNA LoBind, 5.0 mL	Protein LoBind Tubes/ DNA LoBind, 15 mL, conical tubes	Protein LoBind Tubes/ DNA LoBind, 50 mL, conical tubes
137/139	137/139	137/139
conical	conical	conical
25,000 × g/ 25,000 × g		



Microplates

Model	MTP 96/F	MTP 96/U	MTP 96/V
Page(s)	131	131	131
Number of wells	96 wells	96 wells	96 wells
Total volume per well	400 µL	360 µL	350 µL
Working volume	50 – 350 µL	20 – 320 µL	20 – 320 µL
Material	polypropylene	polypropylene	polypropylene
Bottom shape	F bottom	U bottom	V bottom
Dimensions (W x D x H)	127.8 x 85.5 x 14.4 mm	127.8 x 85.5 x 14.4 mm	127.8 x 85.5 x 14.4 mm
Max. RCF	6,000 x g	6,000 x g	6,000 x g

¹⁾ For more Assay/Reader MTPs go to page 166. For Cell Imaging plates go to chapter Cell Imaging Consumables. For twin.tec PCR Plates go to chapter PCR.



Microplates

Model	MTP 384/F	MTP 384/V	MTP UV-VIS 96/F	MTP VIS 96/F	Assay MTP 96/F ¹⁾
Page(s)	131	131	133	133	133
Number of wells	384 wells	384 wells	96 wells	96 wells	96 wells
Total volume per well	150 µL	140 µL	400 µL	400 µL	400 µL
Working volume	10 – 120 µL	10 – 120 µL	50 – 350 µL	50 – 350 µL	50 – 350 µL
Material	polypropylene	polypropylene	polystyrene/film	polystyrene	polypropylene
Bottom shape	F bottom	V bottom	flat	flat	flat
Dimensions (W x D x H)	127.8 x 85.5 x 14.4 mm	127.8 x 85.5 x 14.4 mm	127.8 x 85.5 x 14.4 mm	127.8 x 85.5 x 14.4 mm	127.8 x 85.5 x 14.4 mm
Max. RCF	6,000 x g	6,000 x g	300 x g	3,000 x g	6,000 x g



Deepwell Plates

Model	DWP 96/500	DWP 96/1000	DWP 96/2000	DWP 384/200
Page(s)	135	135	135	135
Number of wells	96 wells	96 wells	96 wells	384 wells
Total volume per well	700 µL	1,200 µL	2,400 µL	240 µL
Working volume	30 – 550 µL	30 – 1,000 µL	50 – 2,000 µL	20 – 225 µL
Material	polypropylene	polypropylene	polypropylene	polypropylene
Bottom shape	conical	conical	conical	conical
Dimensions (W x D x H)	127.8 x 85.5 x 27.1 mm	127.8 x 85.5 x 44.1 mm	127.8 x 85.5 x 44.1 mm	127.8 x 85.5 x 25.1 mm
Max. RCF	6,000 x g	6,000 x g	6,000 x g	6,000 x g



Protein LoBind Plates/ DNA LoBind Plates

Model	MTP 96/V	MTP 384/V	DWP 96/500	DWP 96/1000	DWP 96/2000	DWP 384/200
Page(s)	136/138	136/138	136/138	136/138	136/138	136/138
Number of wells	96 wells	384 wells	96 wells	96 wells	96 wells	384 wells
Total volume per well	350 µL	140 µL	700 µL	1,200 µL	2,400 µL	240 µL
Working volume	20 – 300 µL	5 – 120 µL	30 – 550 µL	30 – 1,000 µL	50 – 2,000 µL	20 – 225 µL
Material	polypropylene	polypropylene	polypropylene	polypropylene	polypropylene	polypropylene
Bottom shape	conical	conical	conical	conical	conical	conical
Dimensions (W x D x H)	127.8 x 85.5 x 14.4 mm	127.8 x 85.5 x 14.4 mm	127.8 x 85.5 x 27.1 mm	127.8 x 85.5 x 44.1 mm	127.8 x 85.5 x 60 mm	127.8 x 85.5 x 25.1 mm
Max. RCF	6,000 x g	6,000 x g	6,000 x g	6,000 x g	6,000 x g	6,000 x g

Eppendorf ThermoMixer® C

You need everything? The Eppendorf ThermoMixer C combines excellent mixing performance with excellent temperature control to ensure complete, dependable and reproducible test results. Improve your assay results by mixing and incubating samples at the same time. The Eppendorf ThermoMixer C convinces users with its quick and easy-to-exchange SmartBlocks for all common lab vessels, new and improved program functions, and high level of stability for every mixing frequency. There is almost no limit to the variety of applications waiting for you!



	Plate type	96-well plates	384-well plates
Mixing of different buffers			
Buffer with detergent	PCR	30 s 1,800 rpm	30 s 2,800 rpm
Buffer without detergent	PCR	1 min 2,000 rpm	30 s 3,000 rpm
Buffer with high salt concentration	DWP	5 s 1,400 rpm	30 s 2,000 rpm
Buffer with DMSO	MTP	5 s 1,100 rpm	5 s 2,000 rpm
Mixing of viscous solutions			
Genomic-DNA	PCR	30 s 2,000 rpm	1 min 3,000 rpm
Resuspension of pellets			
Bacteria cell pellets	DWP	30 s 2,000 rpm	2 min 2,000 rpm

Eppendorf ThermoMixer C provides enough mixing power to handle also challenging mixing tasks. Most samples are efficiently mixed within less than a minute independent of vessel geometry or sample properties. For more informations see AppNote 130.

Product features

- > Mixing, heating, and cooling in one instrument for high flexibility
- > All common vessels and plate formats from 5 µL to 50 mL by different Eppendorf SmartBlocks™ for standard applications
- > Excellent 2^oMix-Control technology results in excellent sample mixing
- > Anti-spill technology prevents lid wetting and cross-contamination
- > Increased mixing frequency of up to 3,000 rpm for effective sample mixing
- > Excellent temperature management for maximum temperature accuracy, resulting in safe handling
- > Compatible with Eppendorf ThermoTop® (**condens.protect**®) for condensation-free sample handling (for Eppendorf SmartBlocks up to 2.0 mL)
- > Predefined program keys and clearly arranged menu guides enable simple and intuitive operations
- > Freely programmable program keys for individual optimization
- > Eppendorf PhysioCare Concept® provides ergonomic design and operation

50 µL sample mixing with 1,800 rpm



Suboptimal sample mixing

Reliable sample mixing

Reliable sample mixing

SmartExtender



Missing a second temperature for an incubation at 37 °C or 95 °C at your Eppendorf ThermoMixer?

The Eppendorf SmartExtender offers a comfortable incubation tool which can easily be used as an add-on to your existing Eppendorf SmartBlocks and the Eppendorf ThermoMixer C/Fx as well as Eppendorf ThermoStat C. Up to 12 vessels (1.5 mL) can be heated up for a higher throughput and higher flexibility in your lab. The independent heating function for the second temperature enables a parallel usage of an Eppendorf SmartBlock and the SmartExtender. The Eppendorf SmartBlock at the center can still be used for heating, cooling, and mixing.

Ordering information

Description	Order no.
SmartExtender, 1.5 mL	5322 000 008

Transfer Racks



Performing a 60-sec-incubation step for 24 samples in parallel?

The Eppendorf Transfer Rack enables a safe and easy transfer of up to 24 samples in parallel to or from the Eppendorf SmartBlock. This provides similar reaction conditions for all samples of your experiment. The Transfer Rack is available for the Eppendorf SmartBlock 0.5 mL as well as the Eppendorf SmartBlock 1.5 and 2.0 mL. These Eppendorf SmartBlocks include a Transfer Rack by standard.

Ordering information

Description	Order no.
Eppendorf ThermoMixer® C, basic device without thermoblock, 220 – 240 V/50 – 60 Hz	5382 000 015
Eppendorf SmartBlock™ 0.5 mL, thermoblock for 24 reaction vessels 0.5 mL, incl. Transfer Rack 0.5 mL	5361 000 031
Eppendorf SmartBlock™ 1.5 mL, thermoblock for 24 reaction vessels 1.5 mL, incl. Transfer Rack 1.5/2.0 mL	5360 000 038
Eppendorf SmartBlock™ 2.0 mL, thermoblock for 24 reaction vessels 2.0 mL, incl. Transfer Rack 1.5/2.0 mL	5362 000 035
Eppendorf SmartBlock™ 5 mL, thermoblock for 8 Eppendorf Tubes® 5.0 mL, 8 × 5.0 mL reaction vessels	5309 000 007
Eppendorf SmartBlock™ 15 mL, thermoblock for 8 conical tubes 15 mL	5366 000 021
Adapter 25 mL for Eppendorf SmartBlock™ 50 mL, Set consisting of 4 adapters and removal tool	5365 000 109
Eppendorf SmartBlock™ 50 mL, thermoblock for 4 conical tubes 50 mL	5365 000 028
Eppendorf SmartBlock™ 12 mm, thermoblock for 24 reaction vessels, diameter up to 12 mm, height 35 mm – 76 mm	5364 000 024
Eppendorf SmartBlock™ cryo, thermoblock for 24 cryo tubes, 1.5 mL – 2 mL, max. external diameter 12.5 mm, all base designs	5367 000 025
Eppendorf SmartBlock™ PCR 96, thermoblock for PCR plates 96, incl. lid	5306 000 006
Eppendorf SmartBlock™ PCR 384, thermoblock for PCR plates 384, incl. lid	5307 000 000
Eppendorf SmartBlock™ DWP 500, thermoblock for Eppendorf Deepwell Plates 96/500 µL, incl. lid	5316 000 004
Eppendorf SmartBlock™ DWP 1000, thermoblock for Eppendorf Deepwell Plate 96/1,000 µL, incl. lid	5310 000 002
Eppendorf SmartBlock™ plates, thermoblock for microplates and Deepwell Plates, incl. lid	5363 000 039
Lid, for Eppendorf ThermoMixer® F0.5/F1.5/F2.0 and FP, for Eppendorf SmartBlock™ 0.5 – 2.0 mL, plates, PCR 96, PCR 384, and DWP	5363 000 233
Transfer Rack 0.5 mL, for Eppendorf SmartBlock™ 0.5 mL	3880 000 305
Transfer Rack 1.5/2.0 mL, for Eppendorf SmartBlock™ 1.5 mL and Eppendorf SmartBlock™ 2.0 mL	3880 000 151
Eppendorf ThermoTop®, with condens.protect ® technology	5308 000 003

Ordering information for other voltage options begins on page 450

Eppendorf ThermoStat™ C

Focusing on temperatures?

Many experiments require fast heating and cooling steps in a very accurate manner. Precise temperature control is achieved for the ThermoStat C by using optimally balanced heating and cooling elements (peltier technology).



Product features

- > Heating and active cooling in all common vessel and plate formats from 5 µL to 50 mL for high flexibility
- > Broad range of Eppendorf SmartBlocks enables high vessel flexibility
- > Excellent temperature accuracy for safe sample handling
- > Very fast cooling rates of up to 5 °C/min, reducing your waiting time
- > Low temperature (e.g. 4 °C or 0 °C) even at higher ambient temperatures for safe sample incubation
- > Temperature keys (4 °C, 16 °C, 37 °C, 56 °C, and 95 °C) provide quick access to commonly used experimental temperatures
- > Eppendorf ThermoTop® (**condens.protect**®) compatibility prevents condensation and improves temperature homogeneity within sample tubes (up to 2.0 mL)
- > Comprehensive range of program slots (up to 15) for flexible usage of device

Ordering information

Description	Order no.
Eppendorf ThermoStat™ C, basic device without thermoblock, 220 – 240 V/50 – 60 Hz	5383 000 019
Eppendorf ThermoTop®, with condens.protect ® technology	5308 000 003
SmartExtender, 1.5 mL	5322 000 008

✎ Ordering information for other voltage options begins on page 450

For more information go to www.eppendorf.com/thermostat-c

Eppendorf SmartBlock™

Using different vessel sizes within your lab workflow?

Flexibility has never been this easy. Eppendorf offers a broad range of Eppendorf SmartBlocks for tubes from 0.2 mL to 50 mL as well as plates (MTP, DWP, and PCR plates 96 / 384) to use with Eppendorf ThermoMixer® C and ThermoStat C. All Eppendorf SmartBlocks are equipped with the outstanding Eppendorf QuickRelease™ system that makes the block exchange super fast and easy.



Product features

- > Optimized block design supports optimal temperature transfer within your sample to receive excellent results
- > Eppendorf SmartBlock-specific calibration by integrated sensor technology maximizes temperature accuracy and homogeneity
- > Every Eppendorf SmartBlock is individually inspected in production for temperature accuracy and is delivered incl. a serial-number specific certificate for documentation purpose
- > Insulated thermoblocks for ergonomic operation – you won't burn your fingers (PhysioCare Concept)
- > Automatic block recognition for safe handling
- > Optimized block design ensures maximum temperature transfer to the sample
- > Eppendorf QuickRelease™ technology enables fast and simple block exchange – no need for tools

Eppendorf SmartBlocks for the following reaction vessels:

- A. 24 lab vessels up to 12 mm in diameter
- B. 8 × 15 mL conical tubes
- C. 4 × 50 mL conical tubes
- D. Eppendorf Deepwell Plates 96/500 µL
- E. Eppendorf Deepwell Plates 96/1000 µL
- F. 24 × cryo tubes
- G. 8 × Eppendorf Tubes® 5.0 mL
- H. Lid for Eppendorf SmartBlock plates, PCR 96, PCR 384, DWP, 0.5 mL, 1.5 mL and 2.0 mL
- I. 384-well PCR plates
- J. 96-well PCR plates
- K. 24 × 0.5 mL vessels
- L. 24 × 1.5 mL vessels
- M. 24 × 2.0 mL vessels
- N. MTPs and Deepwell Plates
- O. 4 × 25 mL adapter for SmartBlock 50 mL

For more information go to www.eppendorf.com/smartblocks

Eppendorf SmartBlock™



Technical specifications						
Description	Lid ¹⁾	Max. speed ²⁾	Max. temp.	ThermoMixer C / ThermoStat C	ThermoTop	SmartExtender
Eppendorf SmartBlock™ 0.5 mL	■	2,000 rpm	100 °C	■	■	■
Eppendorf SmartBlock™ 1.5 mL	■	2,000 rpm	100 °C	■	■	■
Eppendorf SmartBlock™ 2.0 mL	■	2,000 rpm	100 °C	■	■	■
Eppendorf SmartBlock™ 5 mL	■	1,000 rpm	100 °C	■	■	■
Eppendorf SmartBlock™ 15 mL	■	1,000 rpm	100 °C	■	■	■
Eppendorf SmartBlock™ 50 mL	■	1,000 rpm	100 °C	■	■	■
Eppendorf SmartBlock™ 12 mm	■	2,000 rpm	110 °C ⁴⁾	■	■	■
Eppendorf SmartBlock™ cryo	■	2,000 rpm	110 °C ⁴⁾	■	■	■
Eppendorf SmartBlock™ plates	■	3,000 rpm ³⁾	100 °C	■	■	■
Eppendorf SmartBlock™ PCR 96	■	2,000 rpm	100 °C	■	■	■
Eppendorf SmartBlock™ PCR 384	■	3,000 rpm	100 °C	■	■	■
Eppendorf SmartBlock™ DWP 500	■	1,500 rpm	100 °C	■	■	■
Eppendorf SmartBlock™ DWP 1000	■	1,500 rpm	100 °C	■	■	■
Adapter 25 mL for Eppendorf SmartBlock™ 50 mL	■	1,000 rpm	100 °C	■	■	■

¹⁾ Maximum mixing frequency is 2,000 rpm when lid is used ²⁾ Max. speed depends on exact fitting of vessel ³⁾ max. mixing frequency using DWP is 2,000 rpm (80°C and higher: limited to 1,000 rpm) ⁴⁾ Only available with ThermoStat C

Ordering information

Description	Order no.
Eppendorf SmartBlock™ 0.5 mL, thermoblock for 24 reaction vessels 0.5 mL, incl. Transfer Rack 0.5 mL	5361 000 031
Eppendorf SmartBlock™ 1.5 mL, thermoblock for 24 reaction vessels 1.5 mL, incl. Transfer Rack 1.5/2.0 mL	5360 000 038
Eppendorf SmartBlock™ 2.0 mL, thermoblock for 24 reaction vessels 2.0 mL, incl. Transfer Rack 1.5/2.0 mL	5362 000 035
Eppendorf SmartBlock™ 5 mL, thermoblock for 8 Eppendorf Tubes® 5.0 mL, 8 x 5.0 mL reaction vessels	5309 000 007
Eppendorf SmartBlock™ 15 mL, thermoblock for 8 conical tubes 15 mL	5366 000 021
Adapter 25 mL for Eppendorf SmartBlock™ 50 mL, Set consisting of 4 adapters and removal tool	5365 000 109
Eppendorf SmartBlock™ 50 mL, thermoblock for 4 conical tubes 50 mL	5365 000 028
Eppendorf SmartBlock™ 12 mm, thermoblock for 24 reaction vessels, diameter up to 12 mm, height 35 mm – 76 mm	5364 000 024
Eppendorf SmartBlock™ cryo, thermoblock for 24 cryo tubes, 1.5 mL – 2 mL, max. external diameter 12.5 mm, all base designs	5367 000 025
Eppendorf SmartBlock™ PCR 96, thermoblock for PCR plates 96, incl. lid	5306 000 006
Eppendorf SmartBlock™ PCR 384, thermoblock for PCR plates 384, incl. lid	5307 000 000
Eppendorf SmartBlock™ DWP 500, thermoblock for Eppendorf Deepwell Plates 96/500 µL, incl. lid	5316 000 004
Eppendorf SmartBlock™ DWP 1000, thermoblock for Eppendorf Deepwell Plate 96/1,000 µL, incl. lid	5310 000 002
Eppendorf SmartBlock™ plates, thermoblock for microplates and Deepwell Plates, incl. lid	5363 000 039
Lid, for Eppendorf ThermoMixer® F0.5/F1.5/F2.0 and FP, for Eppendorf SmartBlock™ 0.5 – 2.0 mL, plates, PCR 96, PCR 384, and DWP	5363 000 233
Transfer Rack 0.5 mL, for Eppendorf SmartBlock™ 0.5 mL	3880 000 305
Transfer Rack 1.5/2.0 mL, for Eppendorf SmartBlock™ 1.5 mL and Eppendorf SmartBlock™ 2.0 mL	3880 000 151

Eppendorf ThermoTop®

Tired of condensation in your tubes?

We combined the Eppendorf ThermoMixer® with the PCR cycler approach of a heated lid and generated the Eppendorf ThermoTop. The outstanding Eppendorf **condens.protect**® technology reliably prevents condensation within the tube lid – sample concentrations are consistent for the incubation time. In addition, the temperature homogeneity is further improved. Get optimal sample reaction conditions to produce optimal results.

Perfect condensation prevention when dealing with small volumes: The Eppendorf ThermoTop with **condens.protect** technology heated lid avoids condensation on tube lid and tube wall. It is compatible with ThermoMixer C/ ThermoStat C with SmartBlock plates and lab vessels up to 2 mL and ThermoMixer F 0.5/F1.5/F2.0/FP.



Applications

> All temperature control procedures for which the formation of condensation on the tube lid and wall should be reliably avoided



Product features

- > Efficient and reliable of condensation prevention for safe sample heating
- > Get constant reaction conditions for optimal enzymatic performance within your samples
- > Wireless connection with automatic recognition and operation for user-friendly handling
- > Suitable for use with Eppendorf ThermoMixer® F0.5/F1.5/F2.0/FP as well as Eppendorf ThermoMixer C and Eppendorf ThermoStat C with Eppendorf SmartBlocks 0.5 mL, 1.5 mL, 2.0 mL, plates, PCR 96, and PCR 384 (not in combination with Eppendorf Transfer Rack or SmartExtender)



www.eppendorf.com/thermotop-video

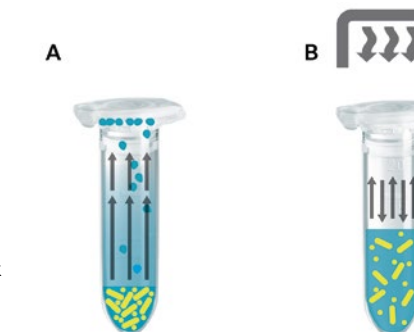

Principle:

A = Condensation without Eppendorf ThermoTop
B = Free of condensation with Eppendorf ThermoTop

Ordering information

Description	Order no.
Eppendorf ThermoTop®, with condens.protect ® technology	5308 000 003

i For more information go to www.eppendorf.com/thermotop

Eppendorf ThermoMixer® F

Doing quite routine sample prep steps?

Whether you regularly work with 0.5/1.5/2.0 mL vessels or plates (MTP and DWP) - our customized fixed-block Eppendorf ThermoMixer F family offers you a good solution for your special application. Just simplify your routine work load.



Product features

- > Heating and mixing in 0.5/1.5/2.0 mL reaction vessels (F0.5/F1.5/F2.0) or plates (FP)
- > Up to 1,500 rpm (F1.5/F2.0) or 2,000 rpm (F0.5/FP) for efficient sample mixing
- > Outstanding ^{2D}Mix-Control technology results in excellent mixing performance
- > Anti-spill technology prevents lid wetting and cross-contamination
- > Compatible with Eppendorf ThermoTop (*condens.protect*®) for condensation-free sample handling
- > Predefined temperature keys (37 °C, 42 °C, 56 °C, and 95 °C) for simple and intuitive operation
- > Very fast heat up speed of up to 18 °C/min, reducing your waiting time
- > Eppendorf PhysioCare Concept® provides ergonomic design and operation



www.eppendorf.com/thermomixer-f-video

Ordering information

Description	Order no.
Eppendorf ThermoMixer® FP, with thermoblock for Microplates and Deepwell Plates, including lid, 220 – 240 V/50 – 60 Hz	5385 000 016
Eppendorf ThermoMixer® F0.5, with thermoblock for 24 reaction vessels 0.5 mL, 200 – 240 V/50 – 60 Hz	5386 000 010
Eppendorf ThermoMixer® F1.5, with thermoblock for 24 reaction vessels 1.5 mL, 220 – 240 V/50 – 60 Hz	5384 000 012
Eppendorf ThermoMixer® F2.0, with thermoblock for 24 reaction vessels 2.0 mL, 220 – 240 V/50 – 60 Hz	5387 000 013
Eppendorf ThermoTop®, with <i>condens.protect</i> ® technology	5308 000 003
SmartExtender, 1.5 mL	5322 000 008

✎ Ordering information for other voltage options begins on page 450

MixMate®

Straight mixing required?

Mix your samples in seconds, fully and reliably. Whether in plates (96 or 384-wells) or reaction tubes, your samples will be optimally processed. With the integrated ergonomic vortex function, the MixMate is your perfect lab assistant. The innovative additional 2 second run timer allows vortexing your next sample without restarting.



	Plate type	96-well plates	384-well plates
Mixing of different buffers			
Buffer with detergent	PCR	15 s 1,800 rpm	45 s 2,800 rpm
	PCR	30 s 2,100 rpm	30 s 3,000 rpm
Buffer without detergent	DWP	5 s 1,400 rpm	1 min 2,000 rpm
	MTP	5 s 1,100 rpm	5 s 2,200 rpm
Mixing of viscous solutions			
Genomic-DNA	PCR	30 s 2,000 rpm	45 s 3,000 rpm
	DWP	30 s 2,000 rpm	3 min 2,000 rpm
Resuspension of pellets			
Bacteria cell pellets	DWP	30 s 2,000 rpm	3 min 2,000 rpm

MixMate provides enough mixing power to handle the most challenging mixing tasks. Most samples are efficiently mixed within less than a minute independent of vessel geometry or sample properties. For more information see AppNote 130.

Product features

- > High-speed mixer (up to 3,000 rpm) for fast and efficient mixing of small volumes in all common vessel formats up to 50 mL
- > ^{2D}Mix-Control technology (planar mixing orbit without vertical movement) for controlled mixing and reproducible results in seconds
- > Anti-spill technology for controlled mixing movements without lid wetting and cross-contamination
- > 5 different tube holders (0.5 mL, 1.5/2.0 mL, 5/15 mL, 25/50 mL, PCR 96-well plates) for high vessel flexibility
- > Integrated ergonomic vortex function for various vessel formats for distinct sample mixing
- > Minimal hand/arm vibration transfer during vortexing (certificate available) for ergonomic operation (PhysioCare Concept®)
- > 5 soft keys with pre-defined standard mixing parameters for easy usage
- > Very stable - remains stationary even at maximum mixing speed
- > Whisper quiet operation to benefit the work environment



Ordering information

Description	Order no.
MixMate®, basic device without tube holders, 230 V/50 – 60 Hz (EU)	5353 000 510
Tube Holder 0.5 mL, for 24 × 0.5 mL reaction vessels	5353 040 121
Tube Holder 1.5/2.0 mL, for 24 × 1.5 mL or 2.0 mL reaction vessels	5353 040 130
Tube Holder 5/15 mL, for 8 × 5/15 mL conical tubes	5353 040 148
Tube Holder 25/50 mL, for 4 × 25/50 mL conical tubes	5353 040 156
Tube Holder PCR 96, for 96 × 0.2 mL PCR tubes, PCR strips or 1 × 96-well PCR plate, semi-skirted or unskirted	5353 040 113

✎ Ordering information for other voltage options begins on page 450

Accessories



IsoTherm-System®

- > IsoTherm-System: IsoRack (work rack), IsoSafe (insulating box), and two IsoPacks (cool packs)
- > Ideal for cooling, transporting, and storing deep-frozen samples
- > Dry incubation technology reduces contamination risk associated with classical icebath incubation for safe sample handling
- > Holds up to 24 micro tubes (e.g., 0.5 mL or 1.5 mL/2.0 mL) for broad flexibility
- > Two versions of IsoPack (cold pack) available: White maintains 0 °C for up to 6 hours. Blue maintains -21 °C for up to 3 hour
- > Racks are stackable, autoclavable and can be centrifuged in the MTP rotor



PCR-Cooler

- > Handling system for sample set-up, protection, transport, and storage of sensitive samples – keep you samples safe
- > Clear temperature indicator: Color of PCR cooler changes when temperature exceeds 7 °C
- > Accommodates PCR-vessels as tubes, strips, or plates for flexible vessel usage
- > Dry incubation technology reduces contamination risk of samples
- > Keeps an entire 96-well PCR plate cold for more than an hour at 0 °C (with two-hour precooling at -20 °C) for safe samples

Color change

Eppendorf PCR-cooler changes color depending on temperature (up to 1 h at 0 °C after precooling at -20 °C)

below 7 °C

above 7 °C



Ordering information

Description	Order no.
IsoTherm-System® starter set , includes IsoSafe, IsoRack, 0 °C IsoPack and -21 °C IsoPack	
for 0.5 mL tubes	3880 000 011
for 1.5/2.0 mL tubes	3880 001 018
IsoPack and IsoRack set , includes one IsoPack and one IsoRack	
for 0.5 mL vessels, 0 °C	3880 000 160
for 0.5 mL vessels, -21 °C	3880 000 178
for 1.5/2.0 mL vessels, 0 °C	3880 001 166
for 1.5/2.0 mL vessels, -21 °C	3880 001 174
IsoSafe and IsoPack , includes 1 IsoSafe and 3 IsoPack	
for 1.5/2.0 mL vessels, 0 °C	3880 001 026
for 1.5/2.0 mL vessels, -21 °C	3880 001 042

Ordering information

Description	Order no.
PCR-Cooler 0.2 mL Starter Set , 1 pink, 1 blue	3881 000 015
PCR-Cooler 0.2 mL , Pink	3881 000 023
PCR-Cooler 0.2 mL , Blue	3881 000 031

Eppendorf Purity Grades for Tubes and Plates

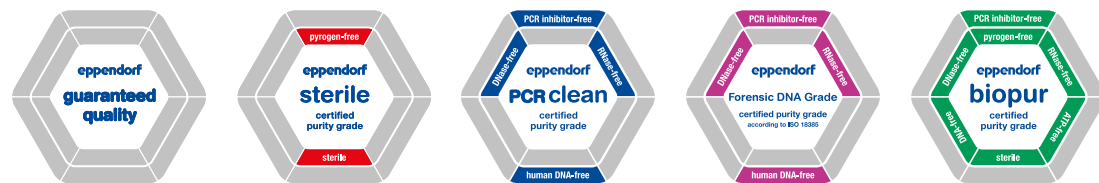

Eppendorf sample handling consumables stand for highest quality and purity

Our tubes and plates are available in a variety of purity grades (see table below) www.eppendorf.com/purity. The purity grades “sterile”, “PCR clean”, “Biopur®” and „Forensic DNA Grade” are certified by an accredited external lab. As a special service, we make the lot-specific certificates available online (www.eppendorf.com/certificates)

Purity grades

Eppendorf purity grades for tubes and plates	Eppendorf Quality™	Eppendorf sterile	Eppendorf PCR clean	Eppendorf Forensic DNA Grade ⁵⁾	Eppendorf Biopur®
Continuous quality control for the following relevant criteria:					
Function, tightness, precision	■	■	■	■	■
Low wetting	■	■	■	■	■
High chemical resistance	■	■	■	■	■
High thermal resistance	■	■	■	■	■
High resistance to centrifugation forces ¹⁾	■	■	■	■	■
High transparency	■	■	■	■	■
Precisely shaped	■	■	■	■	■
Lot-specific certificates²⁾ for the following purity criteria:					
Pyrogen-free ⁶⁾ (endotoxin-free)		■			■
Sterile (Ph.Eur./USP)		■			■
DNA-free ⁶⁾ (Human DNA)			■	■	■
DNA-free ⁶⁾ (Bacteria DNA)					■
DNase-free ⁶⁾			■	■	■
RNase-free ⁶⁾			■	■	■
PCR-inhibitor-free ⁶⁾			■	■	■
ATP-free ⁶⁾					■
Eppendorf Tubes®					
Safe-Lock Tubes	■			■	■ ³⁾
3810X	■				
Eppendorf Tubes® 5.0 mL	■	■	■	■	■ ³⁾
Eppendorf Conical Tubes 25 mL	■	■ ⁴⁾	■		
Conical Tubes 15 mL and 50 mL		■ ⁴⁾		■ ³⁾	
DNA and Protein LoBind Tubes			■		
PCR Tubes (PCR and real-time PCR)			■	■	
Cap Strips (PCR and real-time PCR)			■	■	
Eppendorf Plates® and accessories					
Deepwell Plates and Microplates		■	■		
Protein LoBind Deepwell Plates			■		
DNA LoBind Deepwell Plates			■		
Eppendorf twin.tec® PCR Plates (PCR and real-time PCR)			■		■
Eppendorf twin.tec® PCR Plates				■ ³⁾	■
Heat Sealing Film and Foil			■		
PCR Storage Films and Foils			■		
Plate Lid		■	■		

¹⁾ For accurate details regarding resistance to centrifugation, please refer to the respective product pages. ²⁾ Lot-specific certificate can be downloaded from www.eppendorf.com/certificates. ³⁾ Individually packaged. ⁴⁾ Eppendorf sterile, RNase free, DNase free, DNA free. Testing showed conformity within the detection limits (human and bacteria DNA) ⁵⁾ According to ISO 18385. ⁶⁾ Testing showed conformity within the detection limits



www.eppendorf.com/puritygrades-brochure

Eppendorf Tubes® 3810X

Description

The easy-to-open, securely closing, Eppendorf Tubes® 3810X offers comfort and dependability for sample preparation, centrifugation, and storage. One vessel for all applications in molecular biology, chemistry, and biochemistry.

Safer than ever: Eppendorf Tubes® 3810X are designed for centrifugation up to 30.000 x g!



The 3810X tube ensures tried and tested tight lid closure and easy, stress-free opening and closing.

Product features

- > Tube lid is easy to open and close for ergonomic operation
- > Polypropylene provides high resistance to chemicals, mechanical stress, and temperature extremes
- > g-Safe®: Exceptional centrifugation stability up to 30,000 x g prevents sample loss due to tube breakage and provides extra safety when working with hazardous samples
- > Manufactured without the use of slip agents, plasticizers, and biocides – substances that have been shown to leach from plastic consumables into the sample and negatively affect bio-assay results
- > Graduation for visual control of the pipetted volume
- > Frosted lid and surface on the side for easy labeling
- > Ensured functionality from -86 °C to 100 °C
- > Autoclavable when open (121 °C, 20 min)
- > Available in Eppendorf Quality and lot-certified PCR clean purity grade

Ordering information

Description	Color	Order no.
Eppendorf Tubes® 3810X, 1.5 mL, g-safe® centrifugation stability		
Eppendorf Quality™, 1,000 pcs.	□	0030 125 150
Eppendorf Quality™, 1,000 pcs.	■	0030 125 207
Eppendorf Quality™, 1,000 pcs.	■	0030 125 193
Eppendorf Quality™, 1,000 pcs.	■	0030 125 177
Eppendorf Quality™, 1,000 pcs.	■	0030 125 185
PCR clean, 1,000 pcs.	■	0030 125 215
Eppendorf Tube Rack, 36 positions, for 1.5 mL and 2.0 mL tubes, 2 pcs., polypropylene, numbered positions, autoclavable		
		0030 119 819
Storage Box 8 x 8, for 64 tubes 1 – 2 mL, 3 pcs., height 53 mm, 2 in, polypropylene, for freezing to -86 °C, autoclavable, with lid and alphanumeric code		
		0030 140 524

For more information go to www.eppendorf.com/consumables

Eppendorf Safe-Lock Tubes

Description

Eppendorf Safe-Lock Tubes are the result of 50 years of continuous improvement and development. The original Safe-Lock tubes protect your sample with excellent centrifugation stability, feature optimized sealing properties, and reliably prevent sample evaporation. Trust in the original Eppendorf Safe-Lock Tubes, because your samples deserve nothing but the best.

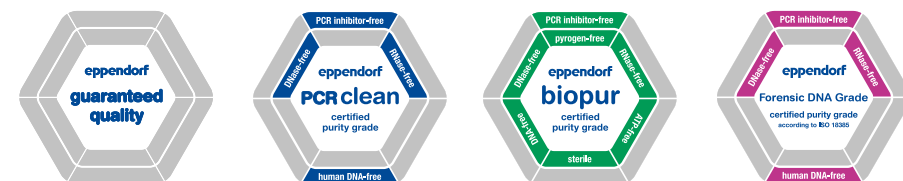

Product features

- > Hinged Eppendorf Safe-Lock lid prevents unintentional lid opening during incubation and storage
- > Polypropylene provides high resistance to chemicals, mechanical stress and temperature extremes
- > Manufactured without the use of slip agents, plasticizers, and biocides – substances that have been shown to leach from plastic consumables into the sample and negatively affect bio-assay results
- > g-Safe®: Depending on Safe-Lock Tube variant (see manual) exceptional centrifugation stability up to 30,000 × g prevents sample loss due to tube breakage and provides extra safety when working with hazardous samples
- > Precise lid sealing for minimal evaporation rates during long-term storage
- > Large frosted lid and surface on the side for easy labeling
- > Ensured functionality from -86 °C to 100 °C
- > Autoclavable when open (121 °C, 20 min)
- > Available in lot-certified PCR clean, Eppendorf Forensic DNA Grade, and Biopur® quality for tested purity
- > Available in Eppendorf Protein and DNA LoBind material for maximum recovery of valuable samples and in Amber for light-sensitive samples

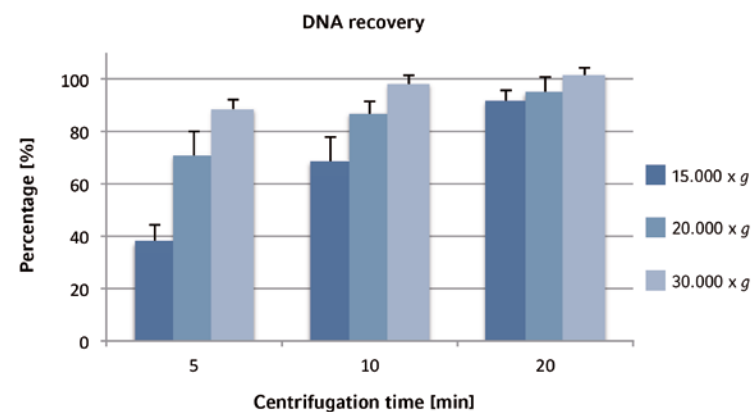

Using the Eppendorf 30,000 × g system comprising of Safe-Lock Tubes and Centrifuge 5430 R with high-speed rotor, the effect of relative centrifugal force (rcf), duration of centrifugation and the amount of isopropanol on the recovery rate of plasmid DNA from alcohol precipitation were investigated. All three factors play a role, with rcf having the greatest effect. By centrifuging the Eppendorf Safe-Lock Tubes at 30,000 × g, nearly 90 % of DNA could be recovered from a 5 min centrifugation. For more information see Application Note 234.

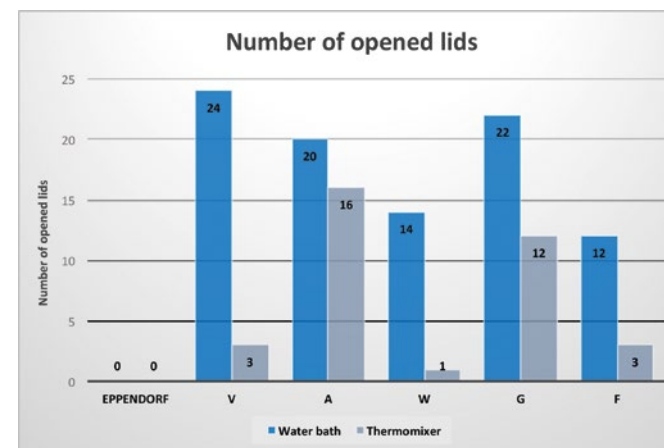

Test conditions: 24 tubes of different manufacturers were incubated either in water bath or thermo mixer with nominal volume (1.5 mL) of 1 % SDS at 100 °C for 10 min.

Ordering information

Description		Order no.
Eppendorf Safe-Lock Tubes, 0.5 mL		
Eppendorf Quality™, 500 tubes	colorless	0030 121 023
Eppendorf Quality™, 500 tubes	yellow	0030 121 112
Eppendorf Quality™, 500 tubes	red	0030 121 120
Eppendorf Quality™, 500 tubes	blue	0030 121 139
Eppendorf Quality™, 500 tubes	green	0030 121 147
Eppendorf Quality™, 500 tubes	assorted colors (per 100)	0030 121 708
Forensic DNA Grade, 500 tubes (10 bags × 50 tubes)	colorless	0030 123 603
PCR clean, 500 tubes	amber (light protection)	0030 121 155
PCR clean, 500 tubes	colorless	0030 123 301
Biopur®, 50 tubes, individually packed	colorless	0030 121 570
Eppendorf Safe-Lock Tubes, 1.5 mL		
Eppendorf Quality™, 1,000 tubes	colorless	0030 120 086
Eppendorf Quality™, 1,000 tubes	yellow	0030 120 159
Eppendorf Quality™, 1,000 tubes	red	0030 120 167
Eppendorf Quality™, 1,000 tubes	blue	0030 120 175
Eppendorf Quality™, 1,000 tubes	green	0030 120 183
Eppendorf Quality™, 1,000 tubes	assorted colors (per 200)	0030 121 694
Biopur®, 100 tubes, individually packed	colorless	0030 121 589
Forensic DNA Grade, 500 tubes (10 bags × 50 tubes)	colorless	0030 123 611
PCR clean, 1,000 tubes	amber (light protection)	0030 120 191
PCR clean, 1,000 tubes	colorless	0030 123 328
Eppendorf Safe-Lock Tubes, 2.0 mL		
Eppendorf Quality™, 1,000 tubes	colorless	0030 120 094
Eppendorf Quality™, 1,000 tubes	yellow	0030 120 205
Eppendorf Quality™, 1,000 tubes	red	0030 120 213
Eppendorf Quality™, 1,000 tubes	blue	0030 120 221
Eppendorf Quality™, 1,000 tubes	green	0030 120 230
Eppendorf Quality™, 1,000 tubes	assorted colors (per 200)	0030 121 686
Biopur®, 100 tubes, individually packed	colorless	0030 121 597
Forensic DNA Grade, 500 tubes (10 bags × 50 tubes)	colorless	0030 123 620
PCR clean, 1,000 tubes	amber (light protection)	0030 120 248
PCR clean, 1,000 tubes	colorless	0030 123 344
Storage Box 8 × 8 , for 64 tubes 1 – 2 mL, 3 pcs., height 53 mm, 2 in, polypropylene, for freezing to -86 °C, autoclavable, with lid and alphanumeric code		0030 140 524
Eppendorf Tube Rack , 36 positions, for 1.5 mL and 2.0 mL tubes, 2 pcs., polypropylene, numbered positions, autoclavable		0030 119 819

For more information go to www.eppendorf.com/SafeLock

Your local distributor: www.eppendorf.com/contact
 Eppendorf AG · Barkhausenweg 1 · 22339 Hamburg · Germany · eppendorf@eppendorf.com · www.eppendorf.com · www.eppendorf.com/eshop

Eppendorf Tubes® 5.0 mL

Description

Eppendorf Tubes are the benchmark for simple and safe sample preparation from 0.5 to 2.0 mL. For larger volumes, 15 mL and 50 mL conical tubes are available. With medium sample volumes you may face an issue: they need to be processed with large conical screw cap tubes - impractical, inconvenient and often prone to contamination. The availability of snap cap and screw cap formats enable the optimized choice for different requirements in sample preparation, incubation, storage, or other applications.



Product features

- > Matching high-speed rotors for Eppendorf Centrifuges 5430/R, 5427 R, 5804/R and 5810/R
- > 5.0 mL adapters and inserts for all existing Eppendorf rotors, with bore holes for 15 mL or 50 mL tubes
- > Functional rack for bench work
- > Storage boxes for freezing
- > 5.0 mL thermoblocks for Eppendorf ThermoMixer® C, Eppendorf Thermomixer® comfort, ThermoStat C and ThermoStat plus
- > 5.0 mL Reservoir Rack Module for the automated pipetting system epMotion®
- > Available in Eppendorf Protein and DNA LoBind material for maximum recovery of valuable samples when only low sample amount is available
- > Available in Amber for light-sensitive samples

Applications

- > Easier processing of samples up to 5.0 mL
- > Higher yields in DNA isolation, especially with samples with limited quantity of source material
- > Convenient and safe cell culture applications
- > Easier sample access lowers the risk of contamination
- > Preparation of mastermixes and buffers
- > Less storage space needed
- > Safe cell and tissue lysis
- > Storage of samples and liquid solutions

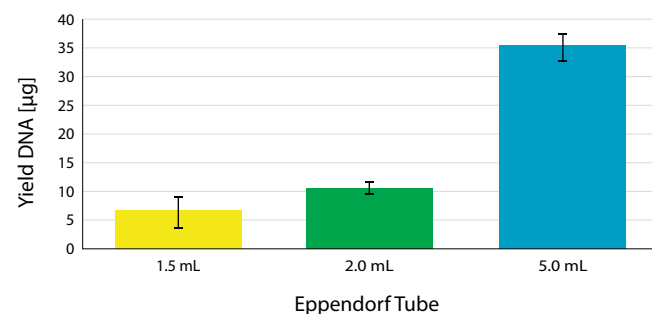

Higher yields in DNA isolation

e.g. the yield of low-copy plasmid DNA can be significantly improved by increasing the culture volume to 5 mL. Data shown in the diagram were generated with 5.0 mL snap cap format – for additional information and protocol description please see Application Note 262.

For more information go to www.eppendorf.com/5mL



Light Protection as well as Transparency

The amber colored Eppendorf Tubes® 5.0 mL with screw cap combine effective protection of your sensitive samples from energy-rich light in the lower wavelength range with a high degree of transparency. You get full control on the insertion depths of pipette tips - often a source of contamination when handling solutions in intransparent tube formats.

Ordering information

Description	Order no.
New Eppendorf Tubes® 5.0 mL with snap cap, 5.0 mL	
Eppendorf Quality™, colorless, 200 tubes (2 bags × 100 tubes)	0030 119 401
PCR clean, colorless, 200 tubes (2 bags × 100 tubes)	0030 119 460
Biopur®, colorless, 50 tubes, individually wrapped	0030 119 479
Forensic DNA Grade, colorless, 200 tubes (4 bags × 50 tubes)	0030 119 606
Sterile, colorless, 200 tubes (10 bags × 20 tubes)	0030 119 487
PCR clean, amber (light protection), 200 tubes (2 bags × 100 tubes)	0030 119 452
New Eppendorf Tubes® 5.0 mL with screw cap, 5.0 mL	
Eppendorf Quality™, colorless, 200 tubes (2 bags × 100 tubes)	0030 122 305
PCR clean, colorless, 200 tubes (2 bags × 100 tubes)	0030 122 313
Sterile, pyrogen-, DNase-, RNase-, human and bacterial DNA-free, colorless, 200 tubes (2 bags × 100 tubes)	0030 122 321
Forensic DNA Grade, colorless, 200 tubes (2 bags × 100 tubes)	0030 122 402
Sterile, pyrogen-, DNase-, RNase-, human and bacterial DNA-free, amber (light protection), 200 tubes (2 bags × 100 tubes)	0030 122 330
Eppendorf Tubes® 5.0 mL with snap cap starter pack , 5.0 mL, 400 tubes (2 packages with 2 bags of 100 each), 2 racks (with 12 locations each), white, 8 universal adapters for rotors with bore holes for 15 mL conical tubes, PCR clean, colorless	0030 119 380
Eppendorf Tubes® 5.0 mL with screw cap, starter pack , 400 tubes (2 packages with 2 bags of 100 each), 2 racks (with 12 locations each), white, 8 universal adapters for rotors with bore holes for 15 mL conical tubes, PCR clean, colorless	0030 122 364
DNA LoBind Tubes , DNA LoBind, 5.0 mL, PCR clean, colorless, 200 tubes (4 bags × 50 tubes)	0030 108 310
Protein LoBind Tubes , Protein LoBind, 5.0 mL, PCR clean, colorless, 100 tubes (2 bags × 50 tubes)	0030 108 302

Ordering information

Eppendorf Tubes® 5.0 mL – System Accessories	Order no.
Tube Clip for Eppendorf Tubes® 5.0 mL , Eppendorf Quality™, 10 pcs.	0030 119 509
Eppendorf Tube Rack , 12 positions, for 5.0 mL and 15 mL tubes, 2 pcs., polypropylene, numbered positions, autoclavable	0030 119 827
Storage Box 5 × 5 , for 25 tubes 5 mL, 4 pcs., height 64 mm, 2.5 in, polypropylene, for freezing to -86 °C, autoclavable, with lid and alphanumeric code	0030 140 532
Storage Box 5 × 5 , for 25 tubes 5 mL screw cap, 2 pcs., height 76 mm, 3 in, polypropylene, for freezing to -86 °C, autoclavable, with lid and alphanumeric code	0030 140 613
Rotor FA-45-12-17 , aerosol-tight, incl. rotor lid, for 12 × Eppendorf Tubes® 5.0 mL	5409 700 006
Rotor FA-45-16-17 , aerosol-tight, incl. rotor lid, for 16 × Eppendorf Tubes® 5.0 mL	5427 750 002
Rotor FA-45-20-17 , incl. rotor lid, for 20 × Eppendorf Tubes® 5.0 mL	5820 765 003
Adapter , for 14 Eppendorf Tubes® 5.0 mL, for Rotor S-4-104, Rotor S-4x1000 round buckets and Rotor S-4x750, set of 2 pcs.	5825 739 000
Adapter , for 1 × Eppendorf Tubes® 5.0 mL, for 100 mL round bucket in Rotor A-4-38, set of 2 pcs.	5702 733 008
Adapter , for 1 × Eppendorf Tubes® 5.0 mL, for Rotor F-35-6-30, small rotor bore, set of 2 pcs.	5427 747 001
Adapter , for 1 Eppendorf Tubes® 5.0 mL, for Rotor F-34-6-38, set of 2 pcs.	5804 777 000
Adapter , for 1 × Eppendorf Tubes® 5.0 mL, for Rotor F-35-6-30, small rotor bore, set of 2 pcs.	5427 746 005
Adapter , for 1 Eppendorf Tubes® 5.0 mL with snap cap, for Rotor FA-45-6-30 and FA-6x50, set of 2 pcs.	5820 730 005
Universal adapter , for 1 × Eppendorf Tubes® 5.0 mL, for rotors for conical 15 mL tubes, set of 8 pcs.	5820 732 008
Adapter , for 8 Eppendorf Tubes® 5.0 mL, for Rotor S-4-72, set of 2 pcs.	5804 793 005
Exchangeable thermoblocks , for 8 × 5.0 mL Eppendorf Tubes®	5309 000 333
Eppendorf SmartBlock™ 5 mL , thermoblock for 8 Eppendorf Tubes® 5.0 mL, 8 × 5.0 mL reaction vessels	5309 000 007
ReservoirRack Module TC , for use in epMotion® ReservoirRacks, temperable, 4 × Eppendorf Tubes® 5.0 mL	5075 799 340

Eppendorf Conical Tubes 25 mL

Description

Discover the new Eppendorf Conical Tubes 25 mL! With the new Eppendorf Conical Tubes 25 mL, we take the field of conical tubes to the next level. When sample volumes higher than 15 mL but much lower than 50 mL must be prepared, centrifuged, mixed, or stored, researchers often have no choice but to use traditional conical screw cap tubes with a volume of either 15 mL or 50 mL. This dilemma is now resolved by the new Eppendorf Conical Tubes 25 mL. They have the same diameter as the 50 mL conical tube but are not as long. Thus the insertion depth of pipettes into the tube is much lower compared to a 50 mL conical tube. The new 25 mL tube is available with screw cap and also with the innovative SnapTec™ cap. This patented lid solution represents a unique snap cap within the conical tubes segment.

New

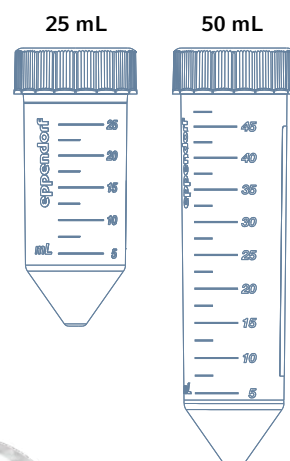

Product features

- > Reduced height gives easy sample access even with low-volume pipettes and tips – reduced risk of cross-contamination between pipette and tube
- > Single-handed opening and closing through SnapTec™ cap version for fast liquid extraction and addition
- > Centrifugation stability up to 17,000 x g¹⁾ for both tube variants - SnapTec™ cap and screw cap
- > Tightness is ensured from -86° C up to 100° C¹⁾
- > Less storage space needed due to ~20 % lower height compared to 50 mL conical tubes
- > Matching accessories for centrifugation, mixing and heating, sample preparation and storage ensure straightforward integration into existing laboratory environment
- > Premium USP class 6 raw material and no use of slip agents, plasticizers, and biocides during manufacturing ensure highest sample integrity and optimal sample and pellet visibility
- > Screw cap with flattened and grooved sides supports a user-friendly ergonomic handling, enables a stable upright positioning, and reduces contamination risk
- > Sterile, pyrogen-, DNase-, RNase-, and DNA-free. Each individual lot is checked and certified for quality and purity.
- > SnapTec™ cap tube can be autoclaved up to 121°C (20 min)¹⁾

¹⁾ Please note the Instructions For Use for details (www.eppendorf.com/manuals): „Eppendorf Conical Tubes 25 mL, snap cap“ and „Eppendorf Conical Tubes 15, 25 and 50 mL“

Applications

- > Cell culture applications, optimal for pooling, e.g. pooling media from 3 x T75 flasks (25 mL)
- > Sample preparation in microbiology and molecular biology labs, e.g. bacteria culture in midi prep size, cloning, DNA extraction when working with a relatively high amount of biological starting material (in botany)
- > Storage and transport of samples and solutions up to 25 mL
- > Preparation of master mixes and buffers



Improved sample processing

Greater diameter and lower height than 15 mL conical tubes enable better sample access and faster resuspension of pellets after centrifugation.



Single-handed operation

Supports optimized and faster handling of sample solutions, especially in multi-step protocols

A Full System of Components



Centrifugation

Centrifuges with rotors for 50 mL conical tubes, e.g. 59xx series and 58xx series: Two adapter variants for snap cap (order no.: 5820 733 004) and screw cap (order no.: 5820 734 000) 25 mL tubes enable usage in 50 mL rotors and buckets.



Heating and Mixing Eppendorf ThermoMixer® C and Eppendorf ThermoStat C:

Adapter for 25 mL tubes ensures compatibility with Eppendorf SmartBlock 50 mL. (order no.: 5365 000 109)



MixMate:

Tube Holder 25/50 mL, for 4 x 25/50 mL conical tubes. (order no.: 5353 040 156)



Sample Storage

Single Tube Stand: Ideally suited for weighing samples on the balance and for handling individual samples. The viewing slit enables observation of the filling level at any time. (order no.: 0030 119 835)



Tube Rack 25 mL:

Eppendorf Racks for 50 mL conical tubes can be used with the new 25 mL tubes. (order no.: 0030 119 835)



Storage box made of polypropylene:

Lower height allows space-saving storage for up to 9 x 25 mL tubes in 3.5 inches Eppendorf Storage Boxes. (order no.: 0030 140 729)

Ordering information

Description	Order no.
Eppendorf Conical Tubes 25 mL with SnapTec™ cap, 25 mL	
Eppendorf Quality™, colorless, 200 tubes (5 bags x 40 tubes)	0030 118 405
PCR clean, colorless, 200 tubes (5 bags x 40 tubes)	0030 118 413
Sterile, pyrogen-, DNase-, RNase-, human and bacterial DNA-free, colorless, 150 tubes (6 bags x 25 tubes)	0030 118 421
Eppendorf Conical Tubes 25 mL with screw cap, 25 mL	
Eppendorf Quality™, colorless, 200 tubes (4 bags x 50 tubes)	0030 122 410
PCR clean, colorless, 200 tubes (4 bags x 50 tubes)	0030 122 429
Sterile, pyrogen-, DNase-, RNase-, human and bacterial DNA-free, colorless, 200 tubes (8 bags x 25 tubes)	0030 122 437

Eppendorf Conical Tubes 15 mL and 50 mL

Description

The Conical Tubes 15 mL and 50 mL extend the volume range of the Eppendorf Tubes®. Safe design and easy handling ensure best sample processing. They represent an optimized solution for cell culture and cell biology applications as well as for sample preparation protocols in microbiology and molecular biology laboratories. Whether centrifugation, mixing, or other applications – the Eppendorf Conical Tubes 15 mL and 50 mL will complete your workflows in an excellent way.

Premium raw material and no use of slip agents, plasticizers, and biocides during manufacturing ensure

- > excellent sample integrity
- > high g-Safe® centrifugation stability
- > optimized sample and pellet visibility

Cap with flattened and grooved sides

- > supports user-friendly ergonomic handling
- > enables a stable upright positioning
- > minimizes contamination risk

Reliable and safe labeling due to a large writing area on the tube and due to a flat and light-colored cap

Precise dimensions enable maximum compatibility with centrifuge rotors, mixers and shakers

Certified purity

- > individual purity certificates are available for each lot

Applications

- > Convenient and safe cell culture applications
- > Sample preparation in microbiology and molecular biology labs
- > Storage of samples and solution with larger volumes
- > Preparation of mastermixes and buffers

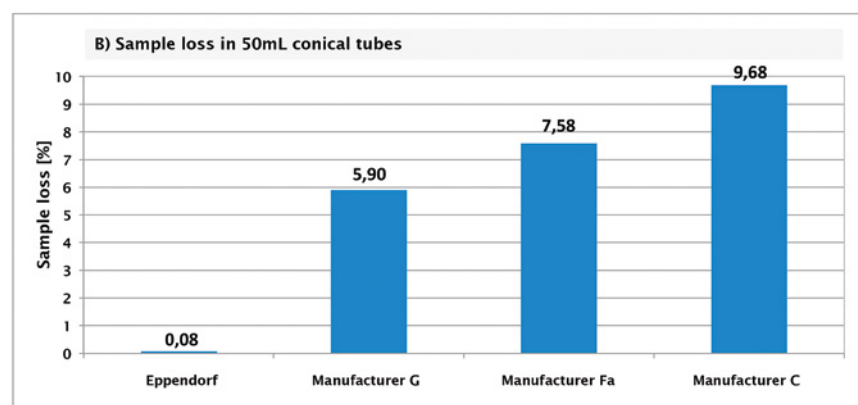

Figure 2: Sample loss after horizontal storage of ethanol in different conical tubes at -86 °C for 24 hours. Sample loss is expressed as percentage of initial weight before storage. For more information see Application Note 343.



Eppendorf Tubes® 5.0 mL with snap cap or screw cap: The ideal complement for smaller volumes (see page 124/125)



Whether centrifugation, mixing, or other applications – the Eppendorf Conical Tubes 15 and 50 mL will complete your workflows in an excellent way



Light Protection as well as Transparency - Two Benefits in one tube

Technical specifications			
Model	Eppendorf Conical Tubes 15 mL	Eppendorf Conical Tubes 50 mL	Eppendorf Conical Tubes
External height / Dimensions external	121 mm / 17 mm	116 mm / 30 mm	
Operating temperature	-86 °C – 100 °C	-86 °C – 100 °C	-86 °C – 100 °C

Ordering information

Description	Order no.
Eppendorf Conical Tubes, 15 mL	
Sterile, pyrogen-, DNase-, RNase-, human and bacterial DNA-free, colorless, 500 tubes (10 bags × 50 tubes)	0030 122 151
Sterile, pyrogen-, DNase-, RNase-, human and bacterial DNA-free, amber (light protection), 200 tubes (4 bags × 50 tubes)	0030 122 194
Forensic DNA Grade, colorless, 100 tubes, individually wrapped	0030 122 259
Sterile, pyrogen-, DNase-, RNase-, human and bacterial DNA-free, colorless, 500 tubes (20 racks × 25 tubes)	0030 122 160
Eppendorf Conical Tubes, 50 mL	
Sterile, pyrogen-, DNase-, RNase-, human and bacterial DNA-free, colorless, 500 tubes (20 bags × 25 tubes)	0030 122 178
Sterile, pyrogen-, DNase-, RNase-, human and bacterial DNA-free, amber (light protection), 200 tubes (8 bags × 25 tubes)	0030 122 224
Forensic DNA Grade, colorless, 48 tubes, individually wrapped	0030 122 267
Sterile, pyrogen-, DNase-, RNase-, human and bacterial DNA-free, colorless, 300 tubes (12 racks × 25 tubes)	0030 122 186
Eppendorf Tube Rack , 12 positions, 6 for 5.0 mL and 15 mL tubes and 6 for 25 mL and 50 mL tubes, 2 pcs., polypropylene, numbered positions, autoclavable	0030 119 835
Eppendorf Tube Rack , 12 positions, for 5.0 mL and 15 mL tubes, 2 pcs., polypropylene, numbered positions, autoclavable	0030 119 827
DNA LoBind Tubes , DNA LoBind, 15 mL, conical tubes, PCR clean, colorless, 200 tubes (4 bags × 50 tubes)	0030 122 208
DNA LoBind Tubes , DNA LoBind, 50 mL, conical tubes, PCR clean, colorless, 200 tubes (4 bags × 50 tubes)	0030 122 232
Protein LoBind Tubes , Protein LoBind, 15 mL, conical tube, PCR clean, colorless, 200 tubes (4 bags × 50 tubes)	0030 122 216
Protein LoBind Tubes , Protein LoBind, 50 mL, conical tube, PCR clean, colorless, 200 tubes (4 bags × 50 tubes)	0030 122 240
Storage Box 5 × 5 , for 25 tubes 15 mL, 2 pcs., height 127 mm, 5 in, polypropylene, for freezing to -86 °C, autoclavable, with lid and alphanumeric code	0030 140 583
Storage Box 3 × 3 , for 9 tubes 50 mL and 4 tubes 15 mL, 2 pcs., height 127 mm, 5 in, polypropylene, for freezing to -86 °C, autoclavable, with lid and alphanumeric code	0030 140 591

For more information go to www.eppendorf.com/consumables

Eppendorf Microplates

Description

The Eppendorf Microplates bring an outstanding clarity to your laboratory! It has never been this easy to pipette, control and recover samples with a polypropylene microplate. The easy-to-read alphanumeric label of the OptiTrack® matrix on each plate makes it unbelievably easy to identify individual wells, speeds up the filling process and significantly reduces the risk of errors. The high transparency is outstanding and ensures that you can always quickly locate your samples. The Microplates are also available in Eppendorf LoBind material for maximum sample recovery when only limited amount of sample material is available.

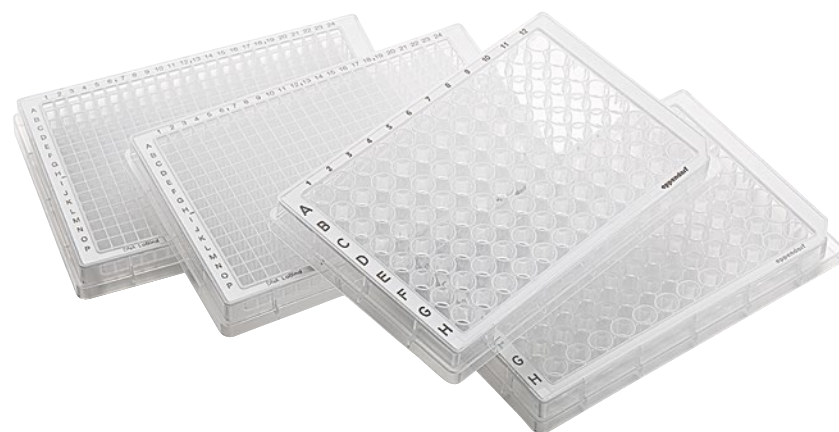
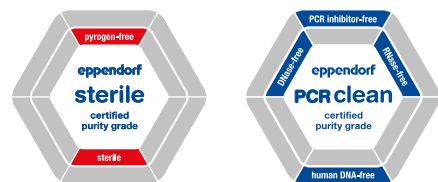

Product features

- > Unmatched, transparent polypropylene (PP) for improved sample visibility
- > OptiTrack® Matrix: up to 30 % faster sample identification and fewer pipetting errors via high-contrast alphanumeric labeling
- > RecoverMax® well design: Optimized well geometry for minimal remaining volume and excellent mixing properties
- > Raised well rims and smooth surface for reliable closing, even with heat sealing
- > g-Safe®: exceptional centrifugation stability up to 6,000 × g
- > Polypropylene ensures high resistance to chemicals, mechanical stress and temperature extremes
- > Manufactured without slip agents, plastocizers or biocides – Materials which could have a negative effect on bioassays
- > Ensured functionality from -86 °C to 100 °C
- > Autoclavable (121 °C, 20 min)
- > Available with barcode. Additional details available at: www.eppendorf.com/barcode







Applications

- > Sample storage and preparation
- > Assays that require high resistance against temperature or solvents
- > Active ingredient screening
- > Combinatorial chemistry
- > Storage of cDNA or genomic banks
- > Protein analysis
- > Genotyping
- > Storage of siRNA or oligonucleotide libraries
- > Preparation of tissue and plant lysates

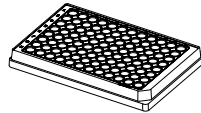
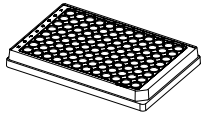
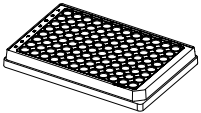
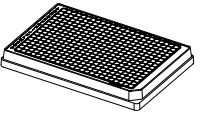
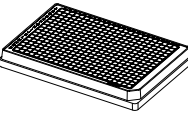
For more information go to www.eppendorf.com/consumables

Technical specifications subject to change.

Technical specifications

					
Description	Microplate 96/F	Microplate 96/U	Microplate 96/V	Microplate 384/F	Microplate 384/V-PP
Number of wells	96 wells	96 wells	96 wells	384 wells	384 wells
Working volume	50 – 350 µL	20 – 320 µL	20 – 320 µL	10 – 120 µL	5 – 120 µL
Total volume per well	400 µL	360 µL	350 µL	150 µL	140 µL
					
Bottom shape	F bottom	U bottom	V bottom	F bottom	conical

Ordering information

Description	OptiTrack® frame color	Order no.
Microplate 96/F , wells clear, RecoverMax® well design		
PCR clean, 80 plates (5 bags × 16 plates)	white <input type="checkbox"/>	0030 601 106
Sterile, 80 plates (5 bags × 16 plates)	white <input type="checkbox"/>	0030 602 102
Microplate 96/U , wells clear, RecoverMax® well design		
PCR clean, 80 plates (5 bags × 16 plates)	white <input type="checkbox"/>	0030 601 203
Sterile, 80 plates (5 bags × 16 plates)	white <input type="checkbox"/>	0030 602 200
Microplate 96/V , wells clear, RecoverMax® well design		
PCR clean, 80 plates (5 bags × 16 plates)	white <input type="checkbox"/>	0030 601 300
Sterile, 80 plates (5 bags × 16 plates)	white <input type="checkbox"/>	0030 602 307
Microplate 384/F , wells clear, RecoverMax® well design		
PCR clean, 80 plates (5 bags × 16 plates)	white <input type="checkbox"/>	0030 621 107
Sterile, 80 plates (5 bags × 16 plates)	white <input type="checkbox"/>	0030 622 103
Microplate 384/V , wells clear, RecoverMax® well design		
PCR clean, 80 plates (5 bags × 16 plates)	white <input type="checkbox"/>	0030 621 301
Sterile, 80 plates (5 bags × 16 plates)	white <input type="checkbox"/>	0030 622 308

Your local distributor: www.eppendorf.com/contact

Eppendorf AG · Barkhausenweg 1 · 22339 Hamburg · Germany · eppendorf@eppendorf.com · www.eppendorf.com · www.eppendorf.com/eshop

Eppendorf Assay/Reader Microplates

Description

Eppendorf assay plates are optimized for measuring absorbance assays in the visible and UV range, fluorescence and chemiluminescence assays. Solid plates are suitable for top-reading plate readers. Clear plates and black/clear plates can be used with top- and bottom-reading plate readers.

The black Eppendorf Microplates are ideal for fluorescence detection. An excellent signal-to-noise ratio provides low detection limits in assays – for clear signals even with low-concentration samples! The white Eppendorf Microplates maximize reflection for high sensitivity during detection of luminescence or weak fluorescence signals.



Product features

- > UV-VIS Microplates feature an ultrathin film bottom for excellent light transmission in the UV range
- > Black Eppendorf Microplates offer an excellent signal-to-noise ratio – for clear signals even with low-concentration samples
- > White Eppendorf Microplates are optimized for highest sensitivity in the detection of luminescence signals by maximizing reflection
- > Solid black and white assay plates are made of polypropylene resulting in high resistance to chemicals, mechanical stress, and temperature extremes
- > All plates are optimized for minimal autofluorescence and autoluminescence
- > Available in lot-certified PCR clean purity grade

Applications

- > Clear VIS and UV-VIS plates for all absorbance assays in the visible and UV range
- > Black and white Microplates for Fluorescence and Luminescence detection
- > DNA- and Protein concentration with absorbance or fluorescent dyes
- > Cell based assays
- > Cell viability and apoptosis assays
- > Cell imaging
- > Protocols that require high resistance against temperature or solvents
- > Dilution series
- > Preparation of tissue and plant lysates

For more information go to www.eppendorf.com/consumables

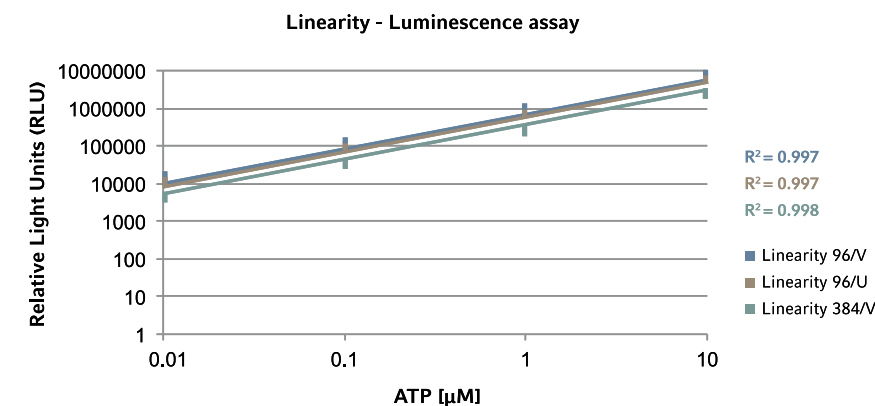

The Eppendorf Microplates 96/V, 96/U and 384/V were tested in a luminescence assay. A ten-fold serial dilution of ATP in culture medium was prepared. Logarithmic plot of data showing linearity of results for the Eppendorf Microplates in the range between 0.01 and 10 μM ATP. For more information see Application Note 215.

Ordering information

Description	Order no.
Microplate 96/F , wells white	
PCR clean, gray, 80 plates (5 bags × 16 plates)	0030 601 475
Microplate 96/U , wells white	
PCR clean, gray, 80 plates (5 bags × 16 plates)	0030 601 572
Microplate 96/V , wells white	
PCR clean, gray, 80 plates (5 bags × 16 plates)	0030 601 670
Microplate 384/V , wells white	
PCR clean, gray, 80 plates (5 bags × 16 plates)	0030 621 670
Microplate 96/F , wells black	
PCR clean, white, 80 plates (5 bags × 16 plates)	0030 601 700
Microplate 96/U , wells black	
PCR clean, white, 80 plates (5 bags × 16 plates)	0030 601 807
Microplate 96/V , wells black	
PCR clean, white, 80 plates (5 bags × 16 plates)	0030 601 904
Microplate 384/V , wells black	
PCR clean, white, 80 plates (5 bags × 16 plates)	0030 621 905
Microplate UV-VIS 96/F , wells clear	
PCR clean, colorless, 40 plates (4 bags × 10 plates)	0030 741 048
Microplate VIS 96/F , wells clear	
PCR clean, colorless, 40 plates (4 bags × 10 plates)	0030 730 020
Eppendorf Cell Imaging Plates , with lid, black with clear F-bottom, Sterile, pyrogen-, DNase-, RNase-, human and bacterial DNA-free. Non-cytotoxic	
96-Well Cell Imaging Plate with 25 μm film bottom, individually wrapped, 20 pcs.	0030 741 013

Eppendorf Deepwell Plates

Description

Eppendorf Deepwell Plates 96 and 384 are high-performance plates for all manual and automated applications – from sample storage at -86 °C to DNA denaturation at 100 °C. Manufactured from pure polypropylene (PP), these plates offer innovative features: More dependability. More efficiency. More stability. The plates are available with a white, yellow, green, or blue border. For easy identification of wells, a high-contrast alphanumeric label is laser-engraved in the border. This OptiTrack® matrix allows you to find your sample up to 30 % more quickly while reducing pipetting errors. With all of these sophisticated features, these plates set new standards in your laboratory.

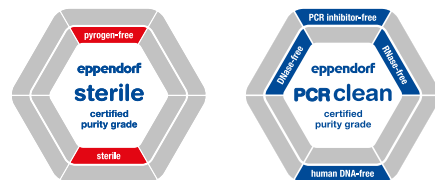

Applications

- > Sample storage and preparation
- > Bacteria and yeast cultivation
- > DNA and RNA isolation with high throughput
- > Storage of cDNA or genomic banks
- > Storage of siRNA or oligonucleotide libraries
- > Protein analysis
- > Storage of valuable protein and DNA samples in Eppendorf LoBind plates
- > Plasmid purification with high throughput
- > Creating dilution series

Product features

- > OptiTrack® matrix: up to 30 % faster sample identification and fewer pipetting errors via high-contrast alphanumeric labeling
- > RecoverMax® well design: Optimized well geometry for maximum sample recovery and excellent mixing properties
- > Minimized remaining volume and high uniformity from well to well
- > Raised well rims and smooth surface for reliable closing, even with heat sealing
- > Easy and reliable stacking
- > g-Safe®: exceptional centrifugation stability up to 6,000 × g for faster protocols and improved sample quality
- > High-quality polypropylene ensures high resistance to chemicals, mechanical stress and temperature extremes
- > Manufactured without slip agents, plasticizers, and biocides – Materials which could have a negative effect on bioassays
- > Autoclavable (121 °C, 20 min)
- > Available with barcode. Additional details available at: www.eppendorf.com/barcode

Technical specifications				
Model	Deepwell Plates 96/500 µL	Deepwell Plates 96/1000 µL	Deepwell Plates 96/2000 µL	Deepwell Plates 384/200 µL
Total volume per well	700 µL	1,200 µL	2,400 µL	240 µL
Working volume per well	30 – 550 µL	30 – 1 000 µL	50 – 2 000 µL	20 – 225 µL
Well shape/Bottom shape				

For more information go to www.eppendorf.com/Deepwellplates

Technical specifications subject to change.

Ordering information

Description	OptiTrack® frame color	Order no.
Deepwell Plate 96/500 µL , wells clear, 500 µL		
PCR clean, 40 plates (5 bags × 8 plates)	white	0030 501 101
PCR clean, 40 plates (5 bags × 8 plates)	yellow	0030 501 110
PCR clean, 40 plates (5 bags × 8 plates)	green	0030 501 136
PCR clean, 40 plates (5 bags × 8 plates)	blue	0030 501 144
PCR clean, 120 plates (10 bags × 12 plates)	white	0030 505 107
Sterile, 40 plates (5 bags × 8 plates)	white	0030 502 108
Sterile, 40 plates (5 bags × 8 plates)	yellow	0030 502 116
Sterile, 40 plates (5 bags × 8 plates)	green	0030 502 132
Sterile, 40 plates (5 bags × 8 plates)	blue	0030 502 140
Sterile, 120 plates (10 bags × 12 plates)	white	0030 506 103
Deepwell Plate 96/1000 µL , wells clear, 1,000 µL		
PCR clean, 20 plates (5 bags × 4 plates)	white	0030 501 209
PCR clean, 20 plates (5 bags × 4 plates)	yellow	0030 501 217
PCR clean, 20 plates (5 bags × 4 plates)	green	0030 501 233
PCR clean, 20 plates (5 bags × 4 plates)	blue	0030 501 241
PCR clean, 80 plates (10 bags × 8 plates)	white	0030 505 204
Sterile, 20 plates (5 bags × 4 plates)	white	0030 502 205
Sterile, 20 plates (5 bags × 4 plates)	yellow	0030 502 213
Sterile, 20 plates (5 bags × 4 plates)	green	0030 502 230
Sterile, 20 plates (5 bags × 4 plates)	blue	0030 502 248
Sterile, 80 plates (10 bags × 8 plates)	white	0030 506 200
Deepwell Plate 96/2000 µL , wells clear, 2,000 µL		
PCR clean, 20 plates (5 bags × 4 plates)	white	0030 501 306
PCR clean, 20 plates (5 bags × 4 plates)	yellow	0030 501 314
PCR clean, 20 plates (5 bags × 4 plates)	green	0030 501 330
PCR clean, 20 plates (5 bags × 4 plates)	blue	0030 501 349
PCR clean, 80 plates (10 bags × 8 plates)	white	0030 505 301
Sterile, 20 plates (5 bags × 4 plates)	white	0030 502 302
Sterile, 20 plates (5 bags × 4 plates)	yellow	0030 502 310
Sterile, 20 plates (5 bags × 4 plates)	green	0030 502 337
Sterile, 20 plates (5 bags × 4 plates)	blue	0030 502 345
Sterile, 80 plates (10 bags × 8 plates)	white	0030 506 308
Deepwell Plate 384/200 µL , wells clear, 200 µL		
PCR clean, 40 plates (5 bags × 8 plates)	white	0030 521 102
Sterile, 40 plates (5 bags × 8 plates)	white	0030 522 109
PCR clean, 120 plates (10 bags × 12 plates)	white	0030 525 108
Sterile, 120 plates (10 bags × 12 plates)	white	0030 526 104



www.eppendorf.com/deepwellplates-brochure

Your local distributor: www.eppendorf.com/contact
Eppendorf AG · Barkhausenweg 1 · 22339 Hamburg · Germany · eppendorf@eppendorf.com · www.eppendorf.com · www.eppendorf.com/eshop

Protein LoBind Plates

Description

Eppendorf LoBind Plates maximize sample recovery by significantly reducing sample binding to the surface. A special, two-component polymer mix creates a hydrophilic surface that ensures optimized recovery rates of valuable samples. Protein LoBind Plates have been specially designed for use in protein research or with sensitive proteomic test methods, and frequently provide significantly improved analysis results.

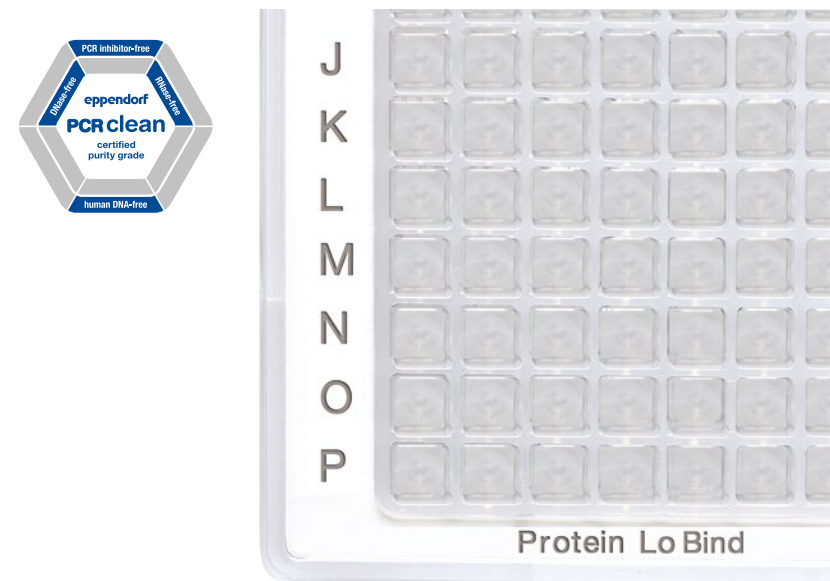

Product features

- > Eppendorf LoBind material ensures excellent sample recovery for improved assay results
- > Free of surface coating (e.g., silicone) to minimize the risk of sample interference
- > Lot-certified PCR clean purity grade: free of human DNA, DNase, RNase and PCR inhibitors
- > Available in tube, microplate, and deepwell plate formats for easy-up scaling
- > High-contrast Unique OptiTrack® matrix: up to 30 % faster sample identification and fewer pipetting errors
- > RecoverMax® well design: optimized well geometry for minimal remaining/dead volume and excellent mixing properties
- > Raised well rims and a smooth surface ensure reliable sealing in plates
- > Available with barcode. Additional details available at: www.eppendorf.com/barcode

Applications

- > Preparation or storage of protein, peptide or antibody samples
- > Enzymatic assays – the hydrophilic surface reduces denaturation when it comes into contact with the tube inner wall
- > Prevention of sample loss during storage of virus stock solutions
- > Storage of cell suspensions

Ordering information

Description	OptiTrack® frame color	Order no.
Deepwell Plate 96/500 µL , Protein LoBind, wells colorless, 500 µL		
PCR clean, 40 plates (5 bags × 8 plates)	<input type="checkbox"/> white	0030 504 100
PCR clean, 40 plates (5 bags × 8 plates)	<input type="checkbox"/> yellow	0030 504 119
PCR clean, 120 plates (10 bags × 12 plates)	<input type="checkbox"/> white	0030 508 106
Deepwell Plate 96/1000 µL , Protein LoBind, wells colorless, 1,000 µL		
PCR clean, 20 plates (5 bags × 4 plates)	<input type="checkbox"/> white	0030 504 208
PCR clean, 20 plates (5 bags × 4 plates)	<input checked="" type="checkbox"/> yellow	0030 504 216
PCR clean, 80 plates (10 bags × 8 plates)	<input type="checkbox"/> white	0030 508 203
Deepwell Plate 96/2000 µL , Protein LoBind, wells colorless, 2,000 µL		
PCR clean, 20 plates (5 bags × 4 plates)	<input type="checkbox"/> white	0030 504 305
Deepwell Plate 384/200 µL , Protein LoBind, wells colorless, 200 µL		
PCR clean, 40 plates (5 bags × 8 plates)	<input type="checkbox"/> white	0030 524 101
PCR clean, 120 plates (10 bags × 12 plates)	<input type="checkbox"/> white	0030 528 107
Microplate 384/V-PP , Protein LoBind, wells clear		
PCR clean, 80 plates (5 bags × 16 plates)	<input type="checkbox"/> white	0030 624 300
PCR clean, 240 plates (10 bags × 24 plates)	<input type="checkbox"/> white	0030 628 306

Protein LoBind Tubes

Description

When biological samples are stored or incubated in standard vessels, over 90 % of the sample can be lost within 24 hours as a result of binding to the plastic surface. Eppendorf LoBind Tubes maximize sample recovery by significantly reducing sample binding to the surface. A special, two-component polymer mix creates a hydrophilic surface that ensures optimized recovery rates of valuable samples. Protein LoBind Tubes have been specially designed for use in protein research or with sensitive proteomic test methods, and frequently provide significantly improved analysis results.



Product features

- > Eppendorf LoBind material ensures optimized sample recovery for improved assay results
- > Free of surface coating (e.g., silicone) to minimize the risk of sample interference
- > Lot-certified PCR clean purity grade: free of human DNA, DNase, RNase and PCR inhibitors
- > Available in tube, microplate, and deepwell plate formats for easy-up scaling
- > Precise lid sealing to minimize evaporation

Applications

- > Preparation or storage of protein, peptide or antibody samples
- > Enzymatic assays – the hydrophilic surface reduces denaturation when it comes into contact with the tube inner wall
- > Prevention of sample loss during storage of virus stock solutions
- > Storage of cell suspensions

Ordering information

Description	Order no.
Protein LoBind Tubes , Protein LoBind, 0.5 mL, PCR clean, colorless, 100 tubes (2 bags × 50 tubes)	0030 108 094
Protein LoBind Tubes , Protein LoBind, 1.5 mL, PCR clean, colorless, 100 tubes (2 bags × 50 tubes)	0030 108 116
Protein LoBind Tubes , Protein LoBind, 2.0 mL, PCR clean, colorless, 100 tubes (2 bags × 50 tubes)	0030 108 132
Protein LoBind Tubes , Protein LoBind, 5.0 mL, PCR clean, colorless, 100 tubes (2 bags × 50 tubes)	0030 108 302
Protein LoBind Tubes , Protein LoBind, 5.0 mL, with screw cap, PCR clean, colorless, 200 tubes (2 bags × 100 tubes)	0030 122 356
Protein LoBind Tubes , Protein LoBind, 15 mL, conical tube, PCR clean, colorless, 200 tubes (4 bags × 50 tubes)	0030 122 216
Protein LoBind Tubes , Protein LoBind, 50 mL, conical tube, PCR clean, colorless, 200 tubes (4 bags × 50 tubes)	0030 122 240

DNA LoBind Plates

Description

DNA LoBind plates improve recovery of nucleic acids by reducing their adsorption to the tube wall. A combination of special manufacturing technologies and selected polypropylene batches ensures nearly 100 % recovery of DNA/RNA molecules-without surface coating to eliminate the risk of sample contamination. Eppendorf DNA LoBind plates are ideal for sample preparation of long-term storage of nucleic acids in forensic, microarrays, NGS applications, and many others.



Product features

- > Eppendorf LoBind material ensures optimized sample recovery for improved assay results
- > Free of surface coating (e.g. silicone) to minimize the risk of sample interference
- > Lot-certified PCR clean purity grade: free of human DNA, DNase, RNase and PCR inhibitors
- > Available in tube, microplate, and deepwell plate formats for easy-up scaling
- > High-contrast Unique OptiTrack® matrix: up to 30 % faster sample identification and fewer pipetting errors
- > RecoverMax® well design: optimized well geometry for minimal remaining/dead volume and excellent mixing properties
- > Raised well rims and a smooth surface ensure reliable sealing
- > Available with barcode. Additional details available at: www.eppendorf.com/barcode

Applications

- > Preparation or storage of DNA and RNA samples
- > Forensic trace analysis
- > Preparing dilution series in quantitative qPCR
- > Sample preparation in next-generation sequencing
- > Creation of genomic or oligonucleotide libraries

Ordering information

Description	OptiTrack® frame color	Order no.
Deepwell Plate 96/500 µL , DNA LoBind, wells colorless, 500 µL, Eppendorf LoBind®		
PCR clean, 40 plates (5 bags × 8 plates)	<input type="checkbox"/> white	0030 503 104
PCR clean, 40 plates (5 bags × 8 plates)	<input type="checkbox"/> blue	0030 503 147
PCR clean, 120 plates (10 bags × 12 plates)	<input type="checkbox"/> white	0030 507 100
Deepwell Plate 96/1000 µL , DNA LoBind, wells colorless, 1,000 µL, Eppendorf LoBind®		
PCR clean, 20 plates (5 bags × 4 plates)	<input type="checkbox"/> white	0030 503 201
PCR clean, 20 plates (5 bags × 4 plates)	<input checked="" type="checkbox"/> blue	0030 503 244
PCR clean, 80 plates (10 bags × 8 plates)	<input type="checkbox"/> white	0030 507 207
Deepwell Plate 384/200 µL , DNA LoBind, wells colorless, 200 µL, Eppendorf LoBind®		
PCR clean, 40 plates (5 bags × 8 plates)	<input type="checkbox"/> white	0030 523 105
PCR clean, 120 plates (10 bags × 12 plates)	<input type="checkbox"/> white	0030 527 100
Microplate 96/V-PP , DNA LoBind, wells colorless, Eppendorf LoBind®		
PCR clean, 80 plates (5 bags × 16 plates)	<input type="checkbox"/> white	0030 603 303
Microplate 384/V-PP , DNA LoBind, wells clear, Eppendorf LoBind®		
PCR clean, 80 plates (5 bags × 16 plates)	<input type="checkbox"/> white	0030 623 304
PCR clean, 240 plates (10 bags × 24 plates)	<input type="checkbox"/> white	0030 627 300

DNA LoBind Tubes

Description

DNA LoBind tubes maximize sample recovery of nucleic acids by significantly reducing sample-to-surface binding. A combination of special manufacturing technologies and selected polypropylene batches ensures nearly 100 % recovery of DNA/RNA molecules-without surface coating to eliminate the risk of sample contamination. DNA LoBind tubes are batch-tested and certified by an independent laboratory to be free from DNA, DNase, RNase, and PCR inhibitors. Eppendorf DNA LoBind tubes are ideal for sample preparation of long-term storage of nucleic acids in forensic, microarrays, NGS applications, and many others.



Product features

- > Eppendorf LoBind material ensures optimized sample recovery for improved assay results
- > Free of surface coating (e.g., silicone) to minimize the risk of sample interference
- > Lot-certified PCR clean purity grade: free of human DNA, DNase, RNase and PCR inhibitors
- > Available in tube, microplate, and deepwell plate formats for easy-up scaling
- > Precise lid sealing for minimal evaporation rates in tube format
- > Rated up to 30,000 × g (25,000 × g for 2.0 mL tube) centrifugation speed for molecular biology applications

Applications

- > Preparation or storage of DNA and RNA samples
- > Forensic trace analysis
- > Preparing dilution series in quantitative qPCR
- > Sample preparation in next-generation sequencing
- > Creation of genomic or oligonucleotide libraries

Ordering information

Description	Order no.
DNA LoBind Tubes , DNA LoBind, 0.5 mL, PCR clean, colorless, 250 tubes (5 bags × 50 tubes)	0030 108 035
DNA LoBind Tubes , DNA LoBind, 1.5 mL, PCR clean, colorless, 250 tubes (5 bags × 50 tubes)	0030 108 051
DNA LoBind Tubes , DNA LoBind, 2.0 mL, PCR clean, colorless, 250 tubes (5 bags × 50 tubes)	0030 108 078
DNA LoBind Tubes , DNA LoBind, 5.0 mL, PCR clean, colorless, 200 tubes (4 bags × 50 tubes)	0030 108 310
DNA LoBind Tubes , DNA LoBind, 5.0 mL, with screw cap, PCR clean, colorless, 200 tubes (2 bags × 100 tubes)	0030 122 348
DNA LoBind Tubes , DNA LoBind, 15 mL, conical tubes, PCR clean, colorless, 200 tubes (4 bags × 50 tubes)	0030 122 208
DNA LoBind Tubes , DNA LoBind, 50 mL, conical tubes, PCR clean, colorless, 200 tubes (4 bags × 50 tubes)	0030 122 232

Tubes Accessories



Sealing options for Sample Preparation and Storage

- > Storage Film and Foil glued seals for simple and dependable sealing during sample storage
- > Heat Sealing Film and Foil for continuous locking with the best evaporation protection
- > Foil products are made of aluminum, can be pierced, and protect light-sensitive samples
- > Film products are transparent and provide protection against unwanted punctures
- > Eppendorf Plate Lid: stable, flexible protection of samples during short-term storage

Ordering information

Description	Order no.
Eppendorf Storage Film , self-adhesive, PCR clean, 100 pcs. (2 bags x 50 pcs.)	0030 127 870
Eppendorf Storage Foil , self-adhesive, PCR clean, 100 pcs.	0030 127 889
Eppendorf Sealing Mat , for DWP 96/2000, PCR clean, 50 pcs. (5 bags x 10 pcs.)	0030 127 960
Eppendorf Sealing Mat , for DWP 96/1000 and DWP 96/500, PCR clean, 50 pcs. (5 bags x 10 pcs.)	0030 127 978
Eppendorf Plates® Lid , for MTP and DWP, PCR clean, 80 pcs. (5 bags x 16 pcs.)	0030 131 517
Eppendorf Plates® Lid , for MTP and DWP, Sterile, 80 pcs. (5 bags x 16 pcs.)	0030 131 525
Eppendorf Heat Sealing Film , PCR clean, 100 pcs.	0030 127 838
Eppendorf Heat Sealing Foil , PCR clean, 100 pcs.	0030 127 854



Eppendorf Tube and Cuvette Racks

- > Made from high quality polypropylene (PP):
- > Ensuring dimensional stability across a broad temperature range (-86° C to 121° C)
- > Providing chemical resistance
- > The racks are UV-light resistant
- > Six different formats always offer the optimal choice for all common tubes and cuvettes
- > A wavelike design enables you to clearly identify your samples, even when tubes are placed vertically in a column
- > Non-slip silicone feet ensure safe handling
- > The racks are laboratory washer-safe for fast and easy cleaning
- > The racks are autoclavable (121° C/20 min) and stackable
- > For more information see: www.eppendorf.com/tube-racks

Ordering information

Description	Order no.
Eppendorf Tube Rack , 48 positions, for 0.5 mL tubes, 2 pcs., polypropylene, numbered positions, autoclavable	0030 119 800
Eppendorf Tube Rack , 36 positions, for 1.5 mL and 2.0 mL tubes, 2 pcs., polypropylene, numbered positions, autoclavable	0030 119 819
Eppendorf Tube Rack , 12 positions, for 5.0 mL and 15 mL tubes, 2 pcs., polypropylene, numbered positions, autoclavable	0030 119 827
Eppendorf Tube Rack , 12 positions, 6 for 5.0 mL and 15 mL tubes and 6 for 25 mL and 50 mL tubes, 2 pcs., polypropylene, numbered positions, autoclavable	0030 119 835
Eppendorf Cuvette Rack , 30 positions, for glass and plastic cuvettes, 2 pcs., polypropylene, numbered positions, autoclavable	0030 119 851
Eppendorf Tube Rack , 36 positions, for cryogenic tubes, 2 pcs., polypropylene, numbered positions, autoclavable	0030 119 843



Micropestle

- > Two sides for optimal fit in 1.5 mL and 2.0 mL vessels
- > Autoclavable (121 °C, 20 min)

Ordering information

Description	Order no.
Micropestle , for resuspending pellets in 1.5/2.0 mL vessels, 10 pcs.	0030 120 973



Eppendorf Storage Boxes

- > Made of polypropylene (PP) for high stability in freezing applications and smooth opening and closing
- > For freezing to -86 °C
- > High-contrast permanent alphanumeric marking of each location through laser labeling enables easy sample reference and minimizes risk of sample mix-up
- > Autoclavable (121 °C, 20 min)
- > Transparent lid for easy and fast sample inspection
- > Flexible labeling on the light colored box and on the 5 writing areas of the lid
- > Optimal use of freezer space due to flexible combination of the different formats

Ordering information

Description	Order no.
Storage Box 10 x 10 , for 100 cryogenic tubes w. int. thread, 3 pcs., height 53 mm, 2 in, polypropylene, for freezing to -86 °C, autoclavable, with lid and alphanumeric code	0030 140 508
Storage Box 9 x 9 , for 81 screw cap (cryog.) tubes 1 – 2 mL, 3 pcs., height 53 mm, 2 in, polypropylene, for freezing to -86 °C, autoclavable, with lid and alphanumeric code	0030 140 516
Storage Box 9 x 9 , for 81 screw cap (cryog.) tubes 3 mL, 2 pcs., height 76 mm, 3 in, polypropylene, for freezing to -86 °C, autoclavable, with lid and alphanumeric code	0030 140 540
Storage Box 9 x 9 , for 81 screw cap (cryog.) tubes 4 – 5 mL, 2 pcs., height 102 mm, 4 in, polypropylene, for freezing to -86 °C, autoclavable, with lid and alphanumeric code	0030 140 567
Storage Box 8 x 8 , for 64 tubes 1 – 2 mL, 3 pcs., height 53 mm, 2 in, polypropylene, for freezing to -86 °C, autoclavable, with lid and alphanumeric code	0030 140 524
Storage Box 5 x 5 , for 25 tubes 5 mL, 4 pcs., height 64 mm, 2.5 in, polypropylene, for freezing to -86 °C, autoclavable, with lid and alphanumeric code	0030 140 532
Storage Box 5 x 5 , for 25 tubes 5 mL screw cap, 2 pcs., height 76 mm, 3 in, polypropylene, for freezing to -86 °C, autoclavable, with lid and alphanumeric code	0030 140 613
Storage Box 5 x 5 , for 25 tubes 15 mL, 2 pcs., height 127 mm, 5 in, polypropylene, for freezing to -86 °C, autoclavable, with lid and alphanumeric code	0030 140 583
Storage Box 3 x 3 , for 9 tubes 25 mL, 2 pcs., height 89 mm, 3.5 in, polypropylene, for freezing to -86 °C, autoclavable, with lid and alphanumeric code	0030 140 729
Storage Box 3 x 3 , for 9 tubes 50 mL and 4 tubes 15 mL, 2 pcs., height 127 mm, 5 in, polypropylene, for freezing to -86 °C, autoclavable, with lid and alphanumeric code	0030 140 591

New



Sample Handling



Model	MiniSpin®/MiniSpin® plus	5418 R	5420
Positioning	Space saving 12-place mini-centrifuge for quick spin downs even in the smallest workstation, non-refrigerated	Compact refrigerated 18-place microcentrifuge for temperature sensitive samples	Small footprint 24-place microcentrifuge for molecular biology routine applications, non-refrigerated
Page(s)	146	147	148
Max. capacity	12 × 1.5/2.0 mL	18 × 1.5/2.0 mL	24 × 1.5/2.0 mL
Max. RCF	12,100 × g/14,100 × g	16,873 × g	21,300 × g
Max. speed	13,400 rpm/14,500 rpm	14,000 rpm	15,060 rpm
Rotors available	2	1	2
Temperature control range		0 °C to +40 °C	
Dimensions (W × D × H)	22.5 × 23.0 × 13.0 cm/ 22.6 × 23.9 × 12.0 cm	30 × 46 × 25 cm	24 × 35 × 22 cm
Height (with open lid)	25 cm	52 cm	44 cm
Weight w/o accessories	3.7 kg	22 kg	13 kg
Max. power consumption	70 W/85 W	320 W	290 W
Tube/plate/bottle capacity			
1.5/2.0 mL Eppendorf Tubes®	12	18	24
Eppendorf Tubes® 5.0 mL	-	-	-
8-place PCR strips	2	-	4
15 mL conical tubes	-	-	-
25 mL conical tubes	-	-	-
50 mL conical tubes	-	-	-
13 mm round-bottom and blood collection tubes	-	-	-
16 mm round-bottom and blood collection tubes	-	-	-
17.5 mm round-bottom and blood collection tubes	-	-	-
PCR plates/MTP	-	-	-
Deepwell plates (DWP)	-	-	-
Remote Device Monitoring and Notifications (VisioNize®)	-	-	-



Model	5424 R	5425	5427 R	5430/5430 R
Positioning	Refrigerated 24-place standard microcentrifuge for temperature sensitive samples	Whisper quiet 24-place standard microcentrifuge with outstanding feature set for broad range of applications, non-refrigerated	High-throughput refrigerated 48-place microcentrifuge for temperature sensitive samples	Crossover microcentrifuge with multipurpose versatility and 12 rotor options including rotor for 15 and 50 mL conical tubes, 30-place high speed rotor and swing-bucket rotor for MTPs or DWPs, refrigerated for temperature sensitive samples or non-refrigerated
Page(s)	149	151	153	156
Max. capacity	24 × 1.5/2.0 mL	10 × 5.0 mL	48 × 1.5/2.0 mL	48 × 1.5/2.0 mL, 6 × 50 mL, 2 × MTP
Max. RCF	21,130 × g	21,300 × g	25,000 × g	30,130 × g
Max. speed	15,000 rpm	15,060 rpm	16,220 rpm	17,500 rpm
Rotors available	4	6	9	12
Temperature control range	-10 °C to +40 °C		-11 °C to 40 °C	-11 °C to 40 °C
Dimensions (W × D × H)	29 × 48 × 26 cm	24 × 39 × 24 cm	31.9 × 54.0 × 25.4 cm	33 × 42 × 25 cm/38 × 64 × 29 cm
Height (with open lid)	51 cm	48 cm		56 cm/63 cm
Weight w/o accessories	21 kg	15.6 kg	30 kg	29 kg/56 kg
Max. power consumption	350 W	280 W	550 W	475 W/1,050 W
Tube/plate/bottle capacity				
1.5/2.0 mL Eppendorf Tubes®	24	24	48	48
Eppendorf Tubes® 5.0 mL	-	10	12	16
8-place PCR strips	4	12	6	8
15 mL conical tubes	-	-	-	6
25 mL conical tubes	-	-	-	6
50 mL conical tubes	-	-	-	6
13 mm round-bottom and blood collection tubes	-	-	-	12
16 mm round-bottom and blood collection tubes	-	-	-	12
17.5 mm round-bottom and blood collection tubes	-	-	-	12
PCR plates/MTP	-	-	-	2
Deepwell plates (DWP)	-	-	-	2
Remote Device Monitoring and Notifications (VisioNize®)	VisioNize-onboard	-	-	-

For more information go to www.eppendorf.com/centrifugation



Technical specifications subject to change.



On page 384 you will find detailed information on services for these products!

Your local distributor: www.eppendorf.com/contact
Eppendorf AG · Barkhausenweg 1 · 22339 Hamburg · Germany · eppendorf@eppendorf.com · www.eppendorf.com · www.eppendorf.com/eshop



Model	5702/5702 R/5702 RH	5804/5804 R
Positioning	General purpose centrifuge with medium capacity for low speed cell culture applications, refrigerated for temperature sensitive samples, active heating and cooling to improve cell viability or non-refrigerated	High speed multipurpose centrifuge with medium capacity, refrigerated for temperature sensitive samples or non-refrigerated
Page(s)	162	168
Max. capacity	4 x 100 mL	4 x 250 mL/2 x 5 MTP
Max. RCF	3,000 x g	20,913 x g
Max. speed	14,400 rpm	14,000 rpm
Temperature control range	-19 °C to 40 °C/-9 °C to 42 °C	-9 °C to 40 °C
Dimensions (W x D x H)	32 x 40 x 24 cm/38 x 58 x 26 cm/38 x 58 x 26 cm	47 x 55 x 34 cm/64 x 55 x 34 cm
Height (with open lid)	53 cm/60 cm/60 cm	74 cm
Footprint (dimensions w/o front panel, WxD)		47 x 50 cm/64 x 50 cm
Weight w/o accessories	20 kg/36 kg/36 kg	55 kg/80 kg
Max. power consumption	200 W/380 W/380 W	900 W/1,650 W
Tube/plate/bottle capacity		
1.5/2.0 mL Eppendorf Tubes®	24	104
Eppendorf Tubes® 5.0 mL	4	32
8-place PCR strips	-	6
15 mL conical tubes	20	40
25 mL conical tubes	4/4	16
50 mL conical tubes	4/4	16
13 mm round-bottom and blood collection tubes	40/40	56
16 mm round-bottom and blood collection tubes	16/16	52
17.5 mm round-bottom and blood collection tubes	24/24	48
180 – 250 mL bottles (flat)	-/-	4
500 mL Corning®	-/-	-
750 mL bottles	-/-	-
1,000 mL Eppendorf bottles	-/-	-
1,000 mL standard bottles	-/-	-
PCR plates/MTP	-/-	10
Deepwell plates (DWP)	-/-	4
Remote Device Monitoring and Notifications (VisioNize®)	-	-



Model	5810/5810 R	Centrifuge 5910 R	Centrifuge 5920 R
Positioning	Compact multipurpose centrifuge with medium capacity, refrigerated for temperature sensitive samples or non-refrigerated	Super versatile multipurpose centrifuge with high capacity for broad range of consumables, refrigerated for temperature sensitive samples	High-throughput multipurpose centrifuge with very high capacity, refrigerated for temperature sensitive samples
Page(s)	168	194	194
Max. capacity	4 x 750 mL/4 x 4 MTP	4 x 1,000 mL/4 x 5 MTP	4 x 1,000 mL/4 x 7 MTP
Max. RCF	20,913 x g	22,132 x g	21,194 x g
Max. speed	14,000 rpm	14,000 rpm	13,700 rpm
Temperature control range	-19 °C to 40 °C	-11 °C to 40 °C	-11 °C to 40 °C
Dimensions (W x D x H)	54 x 61 x 35 cm/70 x 61 x 35 cm	72 x 66 x 37 cm	74 x 71 x 40 cm
Height (with open lid)	80 cm	85 cm	94 cm
Footprint (dimensions w/o front panel, WxD)	54 x 54 cm/70 x 54 cm	72 x 62 cm	74 x 67 cm
Weight w/o accessories	68 kg/99 kg	109 kg	139 kg
Max. power consumption	900 W/1,650 W	1,650 W	1,650 W
Tube/plate/bottle capacity			
200	200	368	
56	64	108	
6			
56	64	108	
32	36	52	
28	36	52	
100	120	196	
80	104	148	
80	84	80	
4	4	8	
4	4	4	
4	4	4	
-	4	-	
-	-	4	
16	20/4	28/8	
4	4	8	
-	-	VisioNize-onboard	

For more information go to www.eppendorf.com/centrifugation



Technical specifications subject to change.



On page 384 you will find detailed information on services for these products!

Your local distributor: www.eppendorf.com/contact
 Eppendorf AG · Barkhausenweg 1 · 22339 Hamburg · Germany · eppendorf@eppendorf.com · www.eppendorf.com · www.eppendorf.com/eshop

MiniSpin®/MiniSpin® plus

Description

Powerful and user-friendly MiniSpin and MiniSpin plus are small enough so that each workstation can be equipped with a „personal“ centrifuge. Two models are available to meet your performance requirements. MiniSpin plus provides speed sufficient for molecular biology separations.



Product features

- > Rotor capacity: 12 x 1.5/2.0 mL vessels, 2 x PCR strip
- > Max. speed: 14,100 x g (14,500 rpm)
- > Extremely compact footprint
- > Acceleration and deceleration time < 13 s
- > User-friendly digital display for time and speed
- > Metal rotor bowl
- > Separate short-spin key for fast and comfortable centrifugation
- > Optimal ventilation flow reduces heating and protects temperature-sensitive samples
- > Soft-touch lid closure for ergonomic lid locking
- > Automatic lid opening at the end of the run to prevent sample warming and to allow easy access to samples

Special features for MiniSpin plus

- > Automatic rpm/rcf conversion
- > Extended time to 99 min or continuous centrifugation

Ordering information

Description	Order no.
Centrifuge MiniSpin®, non-refrigerated, with Rotor F-45-12-11, 230 V/50 – 60 Hz	5452 000 010
Centrifuge MiniSpin® plus, non-refrigerated, with Rotor F-45-12-11, 230 V/50 – 60 Hz	5453 000 015
Rotor F-55-16-5 PCR	5452 727 007
Rotor F-45-12-11	5452 720 008
Adapter, for 1 tube 0.5 mL or Microtainer®, max. Ø 8 mm, for all 1.5/2.0 mL rotors, set of 6 pcs.	5425 716 001
Adapter, for 1 PCR tube 0.2 mL, max. Ø 6 mm, for all 1.5/2.0 mL rotors, set of 6 pcs.	5425 715 005
Adapter, for 1 tube 0.4 mL, max. Ø 6 mm, for all 1.5/2.0 mL rotors, set of 6 pcs.	5425 717 008

✎ Ordering information for other voltage options begins on page 450



Rotor F-45-12-11

- > For 12 x 1.5/2.0 mL tubes



Rotor F-55-16-5 PCR

- > For 2 x PCR strips

Centrifuge 5418 R

Description

The refrigerated Centrifuge 5418 R with its 18-place capacity rotor is specifically designed for low to medium capacity in 1.5/2.0 mL tubes and Microtainer®. Its speed of up to 16,873 x g allows for standard molecular biology applications. Moreover, this compact device has an especially low access height and is characterized by a remarkably quiet operation.



Product features

- > Max. rotor capacity: 18 x 1.5/2.0 mL vessels
- > Max. speed: 16,873 x g (14,000 rpm) for quick separation
- > Small footprint and low access height of 23 cm
- > OptiBowl® design for quiet operation – even without a rotor lid
- > Eppendorf QuickLock® rotor allows for fast and ergonomic lid locking
- > Soft-touch one-finger lid closure for ergonomic operation
- > Temperature range from 0 °C to +40 °C
- > Ensured temperature of 4 °C at maximum rotational speed
- > FastTemp function for quick pre-cooling and maximized temperature accuracy inside the rotor
- > ECO power shut-off engages after 8 hours of nonuse to reduce energy consumption (46 % over night) and extend compressor life (can be deactivated)

Ordering information

Description	Order no.
Centrifuge 5418 R, refrigerated, with Rotor FA-45-18-11 and rotor lid, 230 V/50 – 60 Hz	5401 000 010
Rotor FA-45-18-11, aerosol-tight, 45° angle, 18 places, max. tube diameter 11 mm, incl. rotor lid (aluminum)	5418 707 005
Adapter, for 1 tube 0.5 mL or microtainer, max. Ø 8 mm, for all 1.5/2.0 mL rotors, set of 6 pcs.	5425 716 001
Adapter, for 1 PCR tube 0.2 mL, max. Ø 6 mm, for all 1.5/2.0 mL rotors, set of 6 pcs.	5425 715 005
Adapter, for 1 tube 0.4 mL, max. Ø 6 mm, for all 1.5/2.0 mL rotors, set of 6 pcs.	5425 717 008

✎ Ordering information for other voltage options begins on page 450



Rotor FA-45-18-11

- > For 18 x 1.5/2.0 mL tubes comes standard with unique Eppendorf QuickLock aerosol-tight lid for fast and reliable locking



Adapter for 0.2 mL PCR Tubes

- > Ideal to spin down PCR Tubes after reaction setup. Adapter fits in any Eppendorf 1.5/2.0 mL rotor



Adapter for BD Microtainer® and 0.5 mL tubes

- > The adapter can be used with every Eppendorf rotor for 1.5/2.0 mL tubes

Centrifuge 5420

Description

The new Centrifuge 5420 was designed with your molecular biology routine applications in mind. The spectrum of methods includes DNA/RNA purification, DNA extraction from agarose gels and PCR reaction set-up. It has a particularly small footprint to save space on the lab bench and an easy to clean keypad control panel. You can spin up to 24 tubes from 1.5 to 2.0 mL. Optional adapters extend the volume range to 0.4 and 0.5 mL tubes as well as 0.6 mL BD Microtainer®. A rotor for 32 PCR tubes (0.2 mL) or four PCR strips is available as well. For your safety, the standard rotor provides aerosol-tight containment for the centrifugation of hazardous samples such as viruses, pathogen bacteria or radioactive probes.



Product features

- > Standard rotor for up to 24 x 1.5 and 2.0 mL tubes
- > Rotor option for up to 32 x 0.2 mL PCR tubes or 4 x 8-place PCR strips
- > Adapters for 0.2, 0.4 and 0.5 mL tubes as well as 0.6 mL BD Microtainer®
- > Soft-touch one-finger lid closure for ergonomic lid locking
- > Automatic lid opening at the end of the run to prevent sample warming and to allow easy access to samples
- > High quality anodized aluminum rotors and rotor lids
- > One push short-spin key for quick centrifugation – no need to hold key all the while
- > Easy to clean keypad control panel
- > Particularly small footprint to save precious space on the lab bench: 24 x 35 x 22 cm (W x D x H)
- > Max. speed: 21,300 x g (15,060 rpm)

Ordering information

Description	Order no.
Centrifuge 5420 , non-refrigerated, without rotor, keypad, 230 V/50 – 60 Hz	5420 000 318
Centrifuge 5420 , non-refrigerated, with aerosol-tight Rotor FA-24x2, keypad, 230 V/50 – 60 Hz	5420 000 113
Rotor F-32x0.2-PCR for Centrifuge 5420 , for 32 x 0.2 mL PCR tubes or 4 x 8 PCR strips, incl. rotor lid	5495 404 007
Rotor FA-24x2 for Centrifuge 5420 , aerosol-tight, for 24 x 1.5/2.0 mL tubes, incl. aerosol-tight rotor lid	5495 400 001
Adapter , for 1 tube 0.5 mL or microtainer, max. Ø 8 mm, for all 1.5/2.0 mL rotors, set of 6 pcs.	5425 716 001
Adapter , for 1 PCR tube 0.2 mL, max. Ø 6 mm, for all 1.5/2.0 mL rotors, set of 6 pcs.	5425 715 005
Adapter , for 1 tube 0.4 mL, max. Ø 6 mm, for all 1.5/2.0 mL rotors, set of 6 pcs.	5425 717 008

✎ Ordering information for other voltage options begins on page 450



Rotor FA-24x2 for Centrifuge 5420

- > Max. speed: 21,300 x g (15,060 rpm)
- > Max. capacity: 24 x 1.5/2.0 mL tubes
- > Aerosol-tight



Rotor F-32x0.2-PCR for Centrifuge 5420

- > Max. speed: 18,257 x g (15,060 rpm)
- > Max capacity: 4 x PCR strips or 32 x PCR tubes (0.2 mL)

Centrifuge 5424 R

Description

The refrigerated Centrifuge 5424 R is the laboratory standard when it comes to efficient cooling performance (e.g. quick cooling down from room temperature to set temperature) in a very ergonomic product design. It features state of the art cooling technology to ensure high temperature accuracy for maximized sample protection and best separation results. Ideal for everyday laboratory use.



Product features

- > Max. rotor capacity: 24 x 1.5/2.0 mL vessels
- > Max. speed: 21,130 x g (15,000 rpm)
- > OptiBowl® design for quiet operation, even without a rotor lid
- > Soft-touch one-finger lid closure for ergonomic operation
- > Temperature range from -10 °C to +40 °C
- > ECO power shut-off engages after 8 hours of non-use to reduce energy consumption (40 % over night) and extend compressor life (can be deactivated)
- > FastTemp function for quick pre-cooling of the centrifuge, e.g. from ~ 21 °C to 4 °C in only 8 minutes
- > Ensured temperature of 4 °C at maximum rotational speed
- > Built-in condensation drain to eliminate water accumulation in the rotor chamber
- > The patented compressor technology reduces vibrations and protects your samples

Ordering information

Description	Order no.
Centrifuge 5424 R , refrigerated, without rotor, keypad, 230 V/50 – 60 Hz	5404 000 210
Centrifuge 5424 R , refrigerated, without rotor, rotary knobs, 230 V/50 – 60 Hz	5404 000 610
Centrifuge 5424 R , refrigerated, with Rotor FA-45-24-11, keypad, 230 V/50 – 60 Hz	5404 000 010
Centrifuge 5424 R , refrigerated, with Rotor FA-45-24-11, rotary knobs, 230 V/50 – 60 Hz	5404 000 410

✎ Ordering information for other voltage options begins on page 450

Rotors for Centrifuge 5424 R



Rotor FA-45-24-11

- > Max. speed: 21,130 × g (15,000 rpm)
- > Max. capacity: 24 × 1.5/2.0 mL tubes
- > Aerosol-tight for safe centrifugation of hazardous samples



Rotor FA-45-24-11-Special

- > Max. speed: 21,130 × g (15,000 rpm)
- > Max. capacity: 24 × 1.5/2.0 mL tubes
- > Aerosol-tight for safe centrifugation of hazardous samples
- > PTFE coating for increased chemical resistance



Rotor F-45-18-11-Kit

- > Max. speed: 18,111 × g (15,000 rpm)
- > Max. capacity: 18 × spin columns or 1.5/2.0 mL tubes
- > Extended rim that protects tube caps from shearing off



Rotor F-45-32-5-PCR

- > Max. speed: 18,615 × g (15,000 rpm)
- > Max. capacity: 4 × PCR strips

Ordering information

Description	Order no.
Rotor FA-45-24-11, aerosol-tight	5424 702 007
Rotor FA-45-24-11-Special, aerosol-tight	5424 700 004
Rotor F-45-18-11-Kit	5424 706 002
Rotor F-45-32-5-PCR	5424 704 000
Adapter, for 1 tube 0.5 mL or microtainer, max. Ø 8 mm, for all 1.5/2.0 mL rotors, set of 6 pcs.	5425 716 001
Adapter, for 1 PCR tube 0.2 mL, max. Ø 6 mm, for all 1.5/2.0 mL rotors, set of 6 pcs.	5425 715 005
Adapter, for 1 tube 0.4 mL, max. Ø 6 mm, for all 1.5/2.0 mL rotors, set of 6 pcs.	5425 717 008

For more information go to www.eppendorf.com/centrifugation

Centrifuge 5425

Description

This 24-place centrifuge has been engineered to be extremely quiet. Short runs up to 12 minutes are whisper quiet at an average of 45 dB(A). This is sufficient for centrifugation steps of most routinely used DNA/RNA purification kits. During longer runs the cooling fan works at full capacity to dissipate the heat for the remainder of the run. Centrifuge 5425 is the successor of the legendary Centrifuge 5424. It has everything you loved before plus great new features to make everyday work more enjoyable.



Product features

- > Whisper quiet microcentrifuge for stress-free work
- > Aerosol-tight Eppendorf QuickLock® lids for simple and safe handling
- > Outstanding software features (e.g. 10 acceleration and braking ramps, 3 program buttons, short function without continuous pressing of the key)
- > Extended rotor program (e.g. 5.0 mL rotor, swing-bucket rotor for PCR strips)
- > OptiBowl® design for quiet operation, even without a rotor lid
- > Soft-touch one-finger lid closure for ergonomic operation
- > Automatic lid opening at the end of the run – prevents sample warming and allows easy access to samples
- > Max. rotor capacity: 10 × 5.0 mL vessels
- > Max. speed: 21,300 × g (15,060 rpm)



www.eppendorf.com/app

Ordering information

Description	Order no.
Centrifuge 5425, non-refrigerated, without rotor, keypad, 230 V/50 – 60 Hz	5405 000 310
Centrifuge 5425, non-refrigerated, without rotor, rotary knobs, 230 V/50 – 60 Hz	5405 000 719
Centrifuge 5425, non-refrigerated, with Rotor FA-24x2, keypad, 230 V/50 – 60 Hz	5405 000 115
Centrifuge 5425, non-refrigerated, with Rotor FA-24x2, rotary knobs, 230 V/50 – 60 Hz	5405 000 514

Ordering information for other voltage options begins on page 450

Rotors for Centrifuge 5425



Rotor FA-24x2

- > Max. speed: 21,300 × g (15,060 rpm)
- > Max. capacity: 24 × 1.5/2.0 mL tubes
- > Aerosol-tight with Eppendorf QuickLock® lid



Rotor FA-24x2-PTFE

- > Max. speed: 21,300 × g (15,060 rpm)
- > Max. capacity: 24 × 1.5/2.0 mL tubes
- > Aerosol-tight with Eppendorf QuickLock
- > PTFE coating for increased chemical resistance



Rotor FA-10x5

- > Max. speed: 21,300 × g (15,060 rpm)
- > Max capacity: 10 × Eppendorf Tubes® 5.0 mL
- > Aerosol-tight with Eppendorf QuickLock® lid



Rotor FA-18x2 Kit

- > Max. speed: 18,565 × g (15,060 rpm)
- > Rotor with higher edge for safe centrifugation of up to 18 spin columns
- > Aerosol-tight with Eppendorf QuickLock® lid



Rotor F-32x0.2-PCR

- > Max. speed: 18,134 × g (15,060 rpm)
- > for 4 × PCR strips or 32 × PCR tubes (0,2 mL)



Rotor 96x0.2-PCR

- > Max. speed: 3,217 × g (6,000 rpm)
- > New swing bucket rotor
- > for 12 × 8 PCR strips 0.1/0.2 mL or 4 × 1/4 twin.tec PCR plate 96, unskirted divisible or 96 × PCR tubes with 0.2 mL

Ordering information

Description	Order no.
Rotor FA-24x2, aerosol-tight, for 24 × 1.5/2.0 mL tubes, incl. aerosol-tight rotor lid	5495 500 006
Rotor FA-24x2-PTFE, aerosol-tight, with PTFE coating, for 24 × 1.5/2.0 mL tubes, incl. aerosol-tight rotor lid	5495 503 005
Rotor FA-10x5, aerosol-tight, for 10 × 5.0 mL tubes (snap and screw cap), incl. aerosol-tight rotor lid	5495 505 008
Rotor FA-18x2-Kit, aerosol-tight, for 18 × 1.5/2.0 mL tubes or spin columns, incl. aerosol-tight rotor lid	5495 508 007
Rotor F-32x0.2-PCR, for 32 × 0.2 mL PCR tubes or 4 × 8 PCR strips, incl. rotor lid	5495 510 001
Rotor S-96x0.2-PCR, for 96 × 0.2 mL PCR tubes or 12 × 8 PCR strips, incl. buckets	5495 512 004
Adapter, for 1 tube 0.5 mL or microtainer, max. Ø 8 mm, for all 1.5/2.0 mL rotors, set of 6 pcs.	5425 716 001
Adapter, for 1 PCR tube 0.2 mL, max. Ø 6 mm, for all 1.5/2.0 mL rotors, set of 6 pcs.	5425 715 005
Adapter, for 1 vessel 1.5 – 2.0 mL, for all 5.0 mL rotors, set of 4 pcs.	5820 768 002
Adapter, for 1 cryo tube, for all 5.0 mL rotors, set of 4 pcs.	5820 769 009
Adapter, for 1 HPLC tube, for all 5.0 mL rotors, set of 4 pcs.	5820 770 007
Adapter, for 1 tube 0.4 mL, max. Ø 6 mm, for all 1.5/2.0 mL rotors, set of 6 pcs.	5425 717 008

Centrifuge 5427 R

Description

The refrigerated Centrifuge 5427 R was designed with high-throughput research applications in mind. With its aerosol-tight 48-place rotor it handles even the toughest challenges in a safe and reliable manner to provide you the efficiency boost you need. All aerosol-tight rotors are equipped with the Eppendorf QuickLock® lids for easy rotor lid opening and closing. Choose the Centrifuge 5427 R if a 24-place microcentrifuge doesn't meet your needs regarding tube capacity and if you don't need the extra versatility our cross-over Centrifuge 5430 R can offer you.



Product features

- > Rotor capacity: 48 × 1.5/2.0 mL, 12 × 5.0 mL; Eppendorf QuickLock® rotor allows for fast and ergonomic lid locking
- > Max. speed: 25,000 × g (16,220 rpm)
- > High capacity 48-place rotor significantly increases productivity to save you valuable time
- > Soft touch one-finger closure for ergonomic operation
- > Temperature range from -11 °C to 40 °C
- > FastTemp function for quick pre-cooling of the centrifuge, e.g., from ~ 23 °C to 4 °C in only 11 minutes
- > ECO shut-off can be programmed to engage after 1, 2, 4 or 8 hours of non-use for maximized energy savings and extended compressor life
- > Built-in condensation drain to eliminate water accumulation
- > Automatic rotor recognition and imbalance detection for maximized operational safety

Ordering information

Description	Order no.
Centrifuge 5427 R, refrigerated, without rotor, rotary knobs, 230 V/50 – 60 Hz	5409 000 010
Centrifuge 5427 R, refrigerated, with Rotor FA-45-12-17, rotary knobs, 230 V/50 – 60 Hz	5409 000 630
Centrifuge 5427 R, refrigerated, with Rotor FA-45-30-11, rotary knobs, 230 V/50 – 60 Hz	5409 000 530
Centrifuge 5427 R, refrigerated, with Rotor FA-45-48-11, rotary knobs, 230 V/50 – 60 Hz	5409 000 210

✎ Ordering information for other voltage options begins on page 450

Rotors for Centrifuge 5427 R



Rotor F-45-48-11

- > Max. speed: 18,210 × g (12,700 rpm)
- > Max. capacity: 48 × 1.5/2.0 mL tubes



Rotor FA-45-48-11

- > Max. speed: 18,210 × g (12,700 rpm)
- > Max. capacity: 48 × 1.5/2.0 mL tubes
- > Aerosol-tight with Eppendorf QuickLock® lid



Rotor FA-45-30-11

- > Max. speed: 20,800 × g (14,000 rpm)
- > Max. capacity: 30 × 1.5/2.0 mL tubes
- > Aerosol-tight with Eppendorf QuickLock® lid



Rotor S-24-11-AT

- > Max. speed: 16,049 × g (12,700 rpm)
- > Swing-bucket rotor for 24 × 1.5/2.0 mL tubes
- > Aerosol-tight with Eppendorf QuickLock® lid
- > Perfect for phase-separation applications such as phenol-chloroform extraction



Rotor FA-45-12-17

- > Max. speed: 20,600 × g (14,000 rpm)
- > Max capacity: 12 × Eppendorf Tubes® 5.0 mL
- > Aerosol-tight with Eppendorf QuickLock® lid



Rotor F-45-48-5-PCR

- > Max. speed: 11,710 × g (10,500 rpm)
- > PCR strip rotor for up to 48 × 0.2 mL PCR tubes



Rotor F-45-30-11

- > Max. speed: 20,817 × g (14,000 rpm)
- > Max. capacity: 30 × 1.5/2.0 mL tubes



Rotor FA-45-24-11

- > Max. speed: 25,000 × g (16,220 rpm)
- > Max. capacity: 24 × 1.5/2.0 mL tubes
- > Aerosol-tight with Eppendorf QuickLock® lid



Rotor FA-45-24-11-Kit

- > Max. speed: 19,100 × g (13,200 rpm)
- > Rotor with higher edge for safe centrifugation of up to 24 spin columns
- > Aerosol-tight with Eppendorf QuickLock® lid

Ordering information

Description	Order no.
Rotor FA-45-48-11, aerosol-tight, incl. rotor lid	5409 710 001
Rotor F-45-48-11, incl. rotor lid	5409 712 004
Rotor FA-45-30-11, aerosol-tight, incl. rotor lid	5409 706 004
Rotor F-45-30-11, incl. rotor lid	5409 708 007
Rotor FA-45-24-11, aerosol-tight, incl. rotor lid	5409 702 009
Rotor FA-45-24-11-Kit, aerosol-tight, incl. rotor lid	5409 704 001
Rotor S-24-11-AT, aerosol-tight, incl. wind shield and rotor lid	5409 715 003
Rotor F-45-48-5-PCR	5409 714 007
Rotor FA-45-12-17, aerosol-tight, incl. rotor lid, for 12 × Eppendorf Tubes® 5.0 mL	5409 700 006
Adapter, for 1 tube 0.5 mL or microtainer, max. Ø 8 mm, for all 1.5/2.0 mL rotors, set of 6 pcs.	5425 716 001
Adapter, for 1 PCR tube 0.2 mL, max. Ø 6 mm, for all 1.5/2.0 mL rotors, set of 6 pcs.	5425 715 005
Adapter, for 1 vessel 1.5 – 2.0 mL, for all 5.0 mL rotors, set of 4 pcs.	5820 768 002
Adapter, for 1 cryo tube, for all 5.0 mL rotors, set of 4 pcs.	5820 769 009
Adapter, for 1 HPLC tube, for all 5.0 mL rotors, set of 4 pcs.	5820 770 007
Adapter, for 1 tube 0.4 mL, max. Ø 6 mm, for all 1.5/2.0 mL rotors, set of 6 pcs.	5425 717 008

Centrifuge 5430/5430 R

Description

Unique cross-over Centrifuge 5430 and 5430 R combine the best features of a microcentrifuge (small footprint) and multipurpose centrifuge (versatility) in one instrument. These centrifuges spin rotors for Eppendorf tubes and PCR strips as you would expect from any microcentrifuge. But that's not all. In a compact size, Centrifuge 5430 and 5430 R also accommodate rotors for microplates and 15/50 mL conical tubes. Now, the rotor program has been expanded with additional Eppendorf QuickLock® rotors. This includes 48-place rotors (1.5/2.0 mL), a 16-place rotor for Eppendorf Tubes® 5.0 mL and a swing-bucket rotor (24 × 1.5/2.0 mL). With their unmatched versatility, Centrifuge 5430 and Centrifuge 5430 R are the flagship products among the Eppendorf microcentrifuge portfolio.



Product features

- > Max. rotor capacity: 48 × 1.5/2.0 mL, 6 × 50 mL, 2 × MTP
- > Max. speed: 30,130 × g (17,500 rpm)
- > Remarkable versatility with 12 different rotors
- > Soft-touch one-finger lid closure for ergonomic operation
- > Menu-driven, multi lingual operation menu (English, German, French, Spanish) with large backlit display
- > 5 program keys for easy access to routine programs
- > Saves up to 50 user-defined programs
- > Automatic rotor recognition and imbalance detection for maximized operational safety
- > Eppendorf QuickLock® – System for quickly opening and closing the rotor lid

Special features for Centrifuge 5430 R

- > Temperature range: -11 °C to +40 °C
- > The patented compressor technology reduces vibrations and protects your samples
- > Continuous cooling maintains a constant temperature after the run has been completed – your samples stay cool
- > FastTemp pro® function for programmable pre-cooling according to day and time
- > ECO shut-off engages after 8 hours of nonuse to reduce energy consumption (37 % overnight) and extend compressor life (can be deactivated in menu)
- > Built-in condensation drain to eliminate water accumulation

Ordering information

Description	Order no.
Centrifuge 5430, non-refrigerated, without rotor, keypad, 230 V/50 – 60 Hz	5427 000 015
Centrifuge 5430, non-refrigerated, without rotor, rotary knobs, 230 V/50 – 60 Hz	5427 000 610
Centrifuge 5430, non-refrigerated, with Rotor FA-45-30-11 incl. rotor lid, keypad, 230 V/50 – 60 Hz	5427 000 210
Centrifuge 5430, non-refrigerated, with Rotor FA-45-30-11 incl. rotor lid, rotary knobs, 230 V/50 – 60 Hz	5427 000 415
Centrifuge 5430 R, refrigerated, without rotor, keypad, 230 V/50 – 60 Hz	5428 000 205
Centrifuge 5430 R, refrigerated, without rotor, rotary knobs, 230 V/50 – 60 Hz	5428 000 610
Centrifuge 5430 R, refrigerated, with Rotor FA-45-30-11 and rotor lid, keypad, 230 V/50 – 60 Hz	5428 000 010
Centrifuge 5430 R, refrigerated, with Rotor FA-45-30-11 and rotor lid, rotary knobs, 230 V/50 – 60 Hz	5428 000 410

✎ Ordering information for other voltage options begins on page 450

i For more information go to www.eppendorf.com/centrifugation

Technical specifications subject to change.

Rotors for Centrifuge 5430/5430 R



Rotor FA-45-48-11

- > Max. speed: 18,210 × g (12,700 rpm)
- > Max. capacity: 48 × 1.5/2.0 mL tubes
- > Aerosol-tight for safe centrifugation of hazardous samples
- > Eppendorf QuickLock® lid



Rotor F-45-48-11

- > Max. speed: 18,210 × g (12,700 rpm)
- > Max. capacity: 48 × 1.5/2.0 mL tubes



Rotor S-24-11-AT

- > Max. speed: 16,049 × g (12,700 rpm)
- > Swing-bucket rotor for 24 × 1.5/2.0 mL tubes
- > Aerosol-tight with Eppendorf QuickLock® lid
- > Perfect for phase-separation applications such as phenol-chloroform extraction



Rotor FA-45-16-17

- > Max. speed: 21,191 × g (14,200 rpm)
- > Max. capacity: 16 × Eppendorf Tubes® 5.0 mL
- > Aerosol-tight for safe centrifugation of hazardous samples
- > Eppendorf QuickLock® lid
- > Eppendorf Tubes® 5.0 mL with screw caps only can use up half (8 ×) of the places in the rotor



Rotor FA-45-30-11

- > Max. speed: 20,817 × g (14,000 rpm)
- > Max. capacity: 30 × 1.5/2.0 mL tubes
- > Aerosol-tight for safe centrifugation of hazardous samples
- > PTFE coating for increased chemical resistance
- > Eppendorf QuickLock® lid



Rotor FA-45-24-11-Kit

- > Max. speed: 19,090 × g (13,200 rpm)
- > Rotor with higher edge for safe centrifugation of up to 24 spin columns
- > Aerosol-tight for safe centrifugation of hazardous samples
- > Eppendorf QuickLock® lid



www.eppendorf.com/app

Your local distributor: www.eppendorf.com/contact
Eppendorf AG · Barkhausenweg 1 · 22339 Hamburg · Germany · eppendorf@eppendorf.com · www.eppendorf.com · www.eppendorf.com/eshop

Rotors for Centrifuge 5430/5430 R



Rotor F-45-30-11

- > Max. speed: 20,817 × g (14,000 rpm)
- > Max. capacity: 30 × 1.5/2.0 mL tubes
- > PTFE coating for increased chemical resistance



Rotor FA-45-24-11-HS

- > Max. speed: 30,130 × g (17,500 rpm)
- > Max. capacity: 24 × 1.5/2.0 mL tubes
- > Extremely fast separation results
- > Aerosol-tight for safe centrifugation of hazardous samples
- > PTFE coating for increased chemical resistance



Rotor F-35-6-30

- > Max. speed: 7,745 × g (7,830 rpm)
- > Rotor for 6 × 15/50 mL conical or 12 × Vacutainer® tubes



Rotor A-2-MTP

- > Max. speed: 2,204 × g (4,680 rpm)
- > 2-place swing-bucket rotor for MTP, PCR and Deepwell Plates
- > Windshield design for quiet operation



Rotor F-45-64-5-PCR

- > Max. speed: 13,543 × g (11,800 rpm)
- > PCR strip rotor for up to 64 × 0.2 mL PCR tubes



Rotor F-45-18-17-Cryo

- > Max. speed: 8,324 × g (8,900 rpm)
- > 18-place rotor for Cryovial® tubes

Ordering information

Description	Order no.
Rotor FA-45-16-17 , aerosol-tight, incl. rotor lid, for 16 × Eppendorf Tubes® 5.0 mL	5427 750 002
Adapter , for 1 tube 0.5 mL or microtainer, max. Ø 8 mm, for all 1.5/2.0 mL rotors, set of 6 pcs.	5425 716 001
Adapter , for 1 PCR tube 0.2 mL, max. Ø 6 mm, for all 1.5/2.0 mL rotors, set of 6 pcs.	5425 715 005
Rotor FA-45-48-11 , aerosol-tight, incl. rotor lid	5427 754 008
Rotor F-45-48-11 , incl. rotor lid	5427 755 004
Rotor S-24-11-AT , aerosol-tight, incl. rotor lid	5427 757 007
Rotor FA-45-30-11 , aerosol-tight, incl. rotor lid	5427 753 001
Rotor FA-45-24-11-Kit , aerosol-tight, incl. rotor lid	5427 752 005
Rotor F-45-30-11 , incl. rotor lid	5427 712 003
Rotor FA-45-24-11-HS , aerosol-tight, incl. rotor lid	5427 710 000
Rotor F-35-6-30 , incl. rotor lid, with 6 adapters each for 15 mL/50 mL conical tubes	5427 716 009
Rotor A-2-MTP , incl. wind shield and rotor lid, with 2 buckets	5427 700 005
Rotor F-45-64-5-PCR , incl. rotor lid and adapters	5427 714 006
Rotor F-45-18-17-Cryo , incl. rotor lid and cryovial adapters	5427 705 007
Adapter , for 1 cryo containers (max. Ø 13 mm) or lidded centrifugation tubes (Ø 12.2 mm), max. length 50 mm, for Rotor F-45-18-17-Cryo, set of 6 pcs.	5702 752 002
Adapter , for 1 vessel 1.5 – 2.0 mL, for all 5.0 mL rotors, set of 4 pcs.	5820 768 002
Adapter , for 1 cryo tube, for all 5.0 mL rotors, set of 4 pcs.	5820 769 009
Adapter , for 1 HPLC tube, for all 5.0 mL rotors, set of 4 pcs.	5820 770 007
Adapter , for 1 tube 0.4 mL, max. Ø 6 mm, for all 1.5/2.0 mL rotors, set of 6 pcs.	5425 717 008
Adapter , for 1 HPLC vessel 1.5 mL, for Rotor F-45-18-17-Cryo	5427 708 006

Adapter options 6 x 15/50 mL conical tube rotor

Adapter	Rotor capacity ³⁾	Max. tube dimensions Ø x L	Max. RCF	For bore hole	Order no. ⁴⁾
13 mm round	12	13 × 65 – 89 mm	6,443 × g	small	5427 740 007
			6,100 × g	large	5427 742 000
13 mm round	12	13 × 90 – 110 mm	7,471 × g	small	5427 741 003
			7,129 × g	large	5427 743 006
16 mm round	12	16 × 75 – 105 mm	7,005 × g	small	5427 732 004
			7,005 × g	large	5427 734 007
17 mm round	12	17 × 90 – 125 mm	7,745 × g	small	5427 735 003
			7,403 × g	large	5427 738 002
Eppendorf Tubes® 5.0 mL		17.5 × 80 mm	6,237 × g	small	5427 746 005
			7,129 × g	large	5427 747 001
15 mL conical	6	17.5 × 100 – 125 mm	7,540 × g	small	5427 726 004
30 mL round	6	26 × 92 – 112 mm	7,087 × g	large	5427 736 000
50 mL round	6	29 × 95 – 125 mm	7,581 × g	large	5427 737 006
50 mL conical	6 ^{1) 2)}	29.5 × 100 – 125 mm	7,197 × g	large	5427 727 000
Centriprep®	6	29.5 × 100 – 125 mm	7,567 × g	large	5427 723 005

¹⁾ Three set of 2 included within 6 x 15/50 mL rotor package. ²⁾ Adapter accommodates skirted 50 mL conical tubes. ³⁾ Please perform a manual test to determine the actual loading capacity. ⁴⁾ Set of 2



Technical Specification Microcentrifuges

Technical specifications				
Model	MiniSpin®	MiniSpin® plus	5418 R	5420
Max. RCF	12,100 × g	14,100 × g	16,873 × g	21,300 × g
Max. speed	13,400 rpm	14,500 rpm	14,000 rpm	15,060 rpm
Max. capacity	12 × 1.5/2.0 mL	12 × 1.5/2.0 mL	18 × 1.5/2.0 mL	24 × 1.5/2.0 mL
Rotors available	2	2	1	2
Acceleration time¹⁾	13 s	13 s	11 s	15 s
Deceleration time¹⁾	12 s	12 s	12 s	15 s
Display	large LCD	large LCD	large LCD	large, brightly lit LCD
Timer	15 s – 30 min	15 s to 99 min, with continuous run function	30 s to 9:59 h, with continuous run function	10 s to 9:59 h, with continuous run function
SOFT brake function			no	10 ramps
Noise level	< 49 dB(A)	< 52 dB(A)	< 47 dB(A)	< 56 dB(A) with Rotor FA-24x2
Max. power consumption	70 W	85 W	320 W	290 W
Dimensions (W × D × H)	22.5 × 23.0 × 13.0 cm	22.6 × 23.9 × 12.0 cm	30 × 46 × 25 cm	24 × 35 × 22 cm
Height (with open lid)	25 cm	25 cm	52 cm	44 cm
Weight w/o accessories	3.7 kg	3.7 kg	22 kg	13 kg
Cooling	non-refrigerated	non-refrigerated	refrigerated	non-refrigerated
Temperature control range			0 °C to +40 °C	

¹⁾ Acceleration and deceleration times may vary depending on rotor, load and voltage version.



Technical specifications					
Model	5424 R	5425	5427 R	5430	5430 R
Max. RCF	21,130 × g	21,300 × g	25,000 × g	30,130 × g	30,130 × g
Max. speed	15,000 rpm	15,060 rpm	16,220 rpm	17,500 rpm	17,500 rpm
Max. capacity	24 × 1.5/2.0 mL	10 × 5.0 mL	48 × 1.5/2.0 mL	48 × 1.5/2.0 mL, 6 × 50 mL, 2 × MTP	48 × 1.5/2.0 mL, 6 × 50 mL, 2 × MTP
Rotors available	4	6	9	12	12
Acceleration time¹⁾	15 s	15 s	18 s	14 s	14 s
Deceleration time¹⁾	16 s	15 s	18 s	15 s	15 s
Display	LCD	large, brightly lit LCD	large LCD	large, brightly lit LCD	large, brightly lit LCD
Timer	30 s to 9:59 h, with continuous run function	10 s to 9:59 h, with continuous run function	10 s to 9:59 h	30 s to 99:59 h, with continuous run function	30 s to 99:59 h, with continuous run function
SOFT brake function	yes	10 ramps		yes	yes
Noise level	< 48 dB(A) with Rotor FA-45-24-11	average of 45 dB(A) in the first 12 minutes and < 51 dB(A) thereafter with Rotor FA-24x2	< 46 dB(A) with Rotor F-45-48-11	< 58 dB(A) with Rotor F-45-30-11	< 54 dB(A) with Rotor F-45-30-11
Max. power consumption	350 W	280 W	550 W	475 W	1,050 W
Dimensions (W × D × H)	29 × 48 × 26 cm	24 × 39 × 24 cm	31.9 × 54.0 × 25.4 cm	33 × 42 × 25 cm	38 × 64 × 29 cm
Height (with open lid)	51 cm	48 cm		56 cm	63 cm
Weight w/o accessories	21 kg	15.6 kg	30 kg	29 kg	56 kg
Cooling	refrigerated	non-refrigerated	refrigerated	non-refrigerated	refrigerated
Temperature control range	-10 °C to +40 °C		-11 °C to 40 °C		-11 °C to 40 °C

¹⁾ Acceleration and deceleration times may vary depending on rotor, load and voltage version.



Centrifuge 5702/5702 R/5702 RH

Description

The 5702 family of low speed, general purpose centrifuges was especially designed to meet the requirement of low- to mid-throughput research and cell culture labs. They are compact in design so that one can fit comfortably on every lab bench, quiet in operation to benefit your work environment, and provide 6 different rotor options to accommodate any type of tube.

The right model for your application:

- > Centrifuge 5702 for standard applications
- > Refrigerated Centrifuge 5702 R for heat sensitive samples
- > Heated and refrigerated Centrifuge 5702 RH allows centrifugation under biological conditions to improve cell viability for more accurate results in downstream applications (e.g. cell cultivation)



Product features

- > Max. speed: 3,000 × g (4,400 rpm)
- > Very compact footprint to fit on every lab bench
- > Very quiet operation to benefit your environment
- > Low access height for simple loading and unloading of samples
- > SOFT brake function for slow acceleration and braking. Optimized for cell separation by gradient centrifugation
- > "At set RPM" function starts the timer when the selected rotational speed is reached for reproducible centrifugation runs
- > Key lock to prevent unintentional adjustments
- > Stainless steel rotor chamber is rust-free and easy to clean
- > Electronic imbalance detection for maximum safety

Special features for Centrifuge 5702 R and Centrifuge 5702 RH

- > Temperature settings from -9 °C to 40 °C
- > FastTemp function for fast precooling
- > Continuous cooling maintains a constant temperature after the run has been completed – your samples stay cool
- > ECO shut-off engages after 8 hours of non-use to reduce energy consumption and extend compressor life
- > Two program keys to store routine programs
- > Active heating guarantees high temperature accuracy during the entire centrifugation cycle (only 5702 RH)



www.eppendorf.com/app

For more information go to www.eppendorf.com/centrifugation

Technical specifications subject to change.



Centrifuge 5702 display



Centrifuge 5702 R and 5702 RH display

Technical specifications			
Model	5702	5702 R	5702 RH
Max. RCF	3,000 × g	3,000 × g	3,000 × g
Max. speed	4,400 rpm	4,400 rpm	4,400 rpm
Speed	100 – 4,400 rpm (100 rpm steps)	100 – 4,400 rpm (100 rpm steps)	100 – 4,400 rpm (100 rpm steps)
Max. capacity	4 × 100 mL	4 × 100 mL	4 × 100 mL
Rotors available	6	6	6
Acceleration time ¹⁾	≤19 s	≤20 s	≤19 s
Deceleration time ¹⁾	≤19 s	≤28 s	≤29 s
Display	LCD	LCD	LCD
Timer	0 – 99 min, with continuous run function	0 – 99 min, with continuous run function	0 – 99 min, with continuous run function
SOFT brake function	yes	yes	yes
Noise level	< 52 dB(A) with Rotor A-4-38	<46 dB(A) with Rotor A-4-38	<46 dB(A) with Rotor A-4-38
Max. power consumption	200 W	380 W	380 W
Dimensions (W × D × H)	32 × 40 × 24 cm	38 × 58 × 26 cm	38 × 58 × 26 cm
Height (with open lid)	53 cm	60 cm	60 cm
Weight w/o accessories	20 kg	36 kg	36 kg
Cooling	non-refrigerated	refrigerated	refrigerated/heated
Temperature control range	–	-9 °C to 40 °C	-9 °C to 42 °C

¹⁾ Acceleration and deceleration times may vary depending on rotor, load and voltage version.

Ordering information

Description	Order no.
Centrifuge 5702, non-refrigerated, without rotor, rotary knobs, 230 V/50 – 60 Hz	5702 000 010
Centrifuge 5702, non-refrigerated, with Rotor A-4-38 incl. adapters for 15/50 mL conical tubes, 2 sets of 2 adapters, rotary knobs, 230 V/50 – 60 Hz	5702 000 320
Centrifuge 5702 R, refrigerated, without rotor, rotary knobs, 230 V/50 – 60 Hz	5703 000 010
Centrifuge 5702 R, refrigerated, with Rotor A-4-38 incl. adapters for 13/16 mm blood collection tubes, 2 sets of 2 adapters, rotary knobs, 230 V/50 – 60 Hz	5703 000 320
Centrifuge 5702 R, refrigerated, with Rotor A-4-38 incl. adapters for 15/50 mL conical tubes, 2 sets of 2 adapters, rotary knobs, 230 V/50 – 60 Hz	5703 000 425
Centrifuge 5702 RH, refrigerated/heated, without rotor, rotary knobs, 230 V/50 – 60 Hz	5704 000 010

Ordering information for other voltage options begins on page 450

Your local distributor: www.eppendorf.com/contact

Eppendorf AG · Barkhausenweg 1 · 22339 Hamburg · Germany · eppendorf@eppendorf.com · www.eppendorf.com · www.eppendorf.com/eshop

Rotors for Centrifuge 5702/5702 R/5702 RH



Rotor A-4-38 with round buckets

- > Maximum speed: 3,000 × g (4,400 rpm)
- > Standard rotor for centrifugation of blood collection tubes or 15/50 mL conical tubes
- > Round buckets for vessels with 1.5 – 100 mL
- > Wide variety of adapters for all blood collection tubes and cell culture tube types
- > Aerosol-tight¹⁾ caps for safe centrifugation of hazardous samples optionally available

¹⁾ Aerosol-tightness tested by Public Health England, Porton Down, UK.



Ordering information

Description	Order no.
Rotor A-4-38 with round buckets, incl. 4 round buckets 100 mL	5702 720 003
Round bucket 100 mL, for Rotor A-4-38, set of 4	5702 722 006
Caps for 100 mL round buckets, aerosol-tight, set of 2 pcs.	5702 721 000

Adapters for Rotor A-4-38 with round buckets						
Tube Volume	1.5 – 2.0 mL	1.1 – 1.4 mL	2 – 7 mL	2.6 – 7 mL	4 – 10 mL	Eppendorf Tubes® 5.0 mL
Max. tube diameter	11 mm	8.5 mm	12.5 mm	13.5 mm	16 mm	17 mm
Max. vessel height	43 mm	100 mm	100 mm	100 mm	100 mm	60 mm
Max. vessel height for use with cap/lid¹⁾	43 mm	100 mm	100 mm	100 mm	100 mm	60 mm
Adapter						
Number of vessels per adapter/rotor	4/16	5/20	5/20	4/16	4/16	1/4
Bottom shape	round	flat	flat	flat	flat	flat
Centrifugation radius	134 mm	132 mm	132 mm	132 mm	132 mm	136 mm
Max. RCF	2,900 × g	2,850 × g	2,850 × g	2,850 × g	2,850 × g	2,943 × g
Packing	set of 2 pcs.	set of 2 pcs.	set of 2 pcs.	set of 2 pcs.	set of 2 pcs.	set of 2 pcs.
Order no.	5702 745 006	5702 736 007	5702 737 003	5702 719 005	5702 735 000	5702 733 008

¹⁾ Exceeding the maximum tube length may reduce the loading capacity of the rotor. Please perform a manual swing-out test before starting the centrifuge run to make sure the tubes do not hit the rotor yoke.²⁾ Please order adapter for 25 mL conical tubes snap cap 5820 733 004.³⁾ Please order adapter for 25 mL conical tubes screw cap 5820 734 000.

9 – 15 mL	15 mL conical	15 mL conical	25 mL snap cap ²⁾	25 mL screw cap ³⁾	50 mL conical	85/100 mL
17.5 mm	17.2 mm	17.2 mm	30 mm	30 mm	30 mm	38 mm
100 mm	121 mm	121 mm	83 mm	78.5 mm	115 mm	106 mm
100 mm	120 mm	–	83 mm	78.5 mm	115 mm	106 mm
4/16	1/4	2/8	1/4	1/4	1/4	1/4
round	conical	conical	conical	conical	conical	round
130 mm	137 mm	137 mm	107 mm	97 mm	135 mm	135 mm
2,800 × g	3,000 × g	3,000 × g	2,316 × g	2,100 × g	2,900 × g	2,900 × g
set of 2 pcs.	set of 2 pcs.	set of 2 pcs.	set of 2 pcs.	set of 2 pcs.	set of 2 pcs.	set of 2 pcs.
5702 724 009	5702 732 001	5702 723 002	5702 734 004	5702 734 004	5702 734 004	5702 718 009

i For more information go to www.eppendorf.com/centrifugation

Rotors for Centrifuge 5702/5702 R/5702 RH



Rotor A-4-38 with rectangular buckets

- > Maximum speed: 2,750 × g (4,400 rpm)
- > Rectangular buckets for vessels with 5 – 25 mL

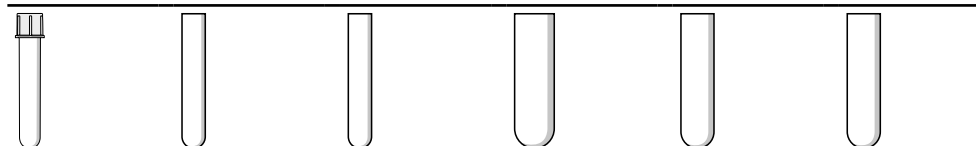

Adapters for Rotor A-4-38 with rectangular buckets

Tube Volume	round-bottom tubes	5 – 7 mL	9 mL	15 mL	25 mL	20 mL
Max. tube diameter	12 mm	13 mm	14.5 mm	17.5 mm	25 mm	22 mm
Max. vessel height	75 mm	100 mm	100 mm	100 mm	100 mm	100 mm
Adapter						
Number of vessels per adapter/rotor	9/36	10/40	8/32	6/24	2/8	4/16
Bottom shape	round	flat	flat	flat	flat	flat
Centrifugation radius	119 mm	127 mm	127 mm	127 mm	127 mm	127 mm
Max. RCF	2,577 × g	2,750 × g	2,750 × g	2,750 × g	2,750 × g	2,750 × g
Packing	set of 2 pcs.	set of 2 pcs.	set of 2 pcs.	set of 2 pcs.	set of 2 pcs.	set of 2 pcs.
Order no.	5702 763 004	5702 710 008	5702 711 004	5702 712 000	5702 716 006	5702 713 007

Ordering information

Description	Order no.
Rotor A-4-38, without buckets	5702 740 004
Rectangular bucket 90 mL, for Rotor A-4-38, set of 4 pcs.	5702 709 000



Rotor A-8-17

- > Maximum speed: 2,800 × g (4,400 rpm)
- > Low capacity rotor for centrifugation of 15 mL conical tubes or 15 mL glass tubes¹⁾
- > Adapters for 15 mL conical tubes and rubber mat inserts for glass tubes optionally available

¹⁾ Max. vessel height: 120 mm



Rotor F-45-24-11

- > Maximum speed: 1,770 × g (4,400 rpm)
- > Fixed-angle rotor for 24 × 1.5/2.0 mL tubes
- > Quiet centrifugation even without rotor lid
- > Adapters optionally available for:
 - 0.2 mL PCR tubes (5425 715 005)
 - 0.4 mL centrifuge tubes (5425 717 008)
 - 0.5 mL micro test tubes and BD Microtainer® tubes (5425 716 001)
- > Rotor and adapters are autoclavable (121 °C, 20 min)



Rotor F-35-30-17

- > Maximum speed: 2,750 × g (4,400 rpm)
- > High capacity rotor for 20 × 15 mL conical tubes or 30 × 15 mL glass tubes
- > Inserts for 15 mL conical tubes and rubber mats for use with glass tubes are included



Rotor F-45-18-17-Cryo

- > Maximum speed: 1,970 × g (4,400 rpm)
- > Quiet centrifugation even without rotor lid
- > Centrifugation of 1 – 2 mL cryo container (max. 13 mm Ø, use with adapter) and tubes with screw cap (max. 17 mm Ø, no adapter required)
- > Rotor and adapters are autoclavable (121 °C, 20 min)

Ordering information

Description	Order no.
Rotor A-8-17, 8 × 15 mL, without adapter, without rubber mats	5702 700 002
Rotor F-35-30-17, incl. 30 steel sleeves for 15 mL vessels, with 20 adapters for conical tubes and 30 rubber mats for round-bottom tubes	5702 704 008
Rotor F-35-30-17, incl. 10 steel sleeves for 15 mL vessels, with 10 adapters for conical tubes and 10 rubber mats for round-bottom tubes	5702 705 004
Rotor F-45-24-11, without lid	5702 746 002
Rotor F-45-18-17-Cryo, without rotor lid, without adapters	5702 747 009
Adapter, for 1 cryo containers (max. Ø 13 mm) or lidded centrifugation tubes (Ø 12.2 mm), max. length 50 mm, for Rotor F-45-18-17-Cryo, set of 6 pcs.	5702 752 002
Adapter, for 1 HPLC vessel 1.5 mL, for Rotor F-45-18-17-Cryo	5427 708 006

Centrifuge 5804/5804 R and 5810/5810 R



Description

Eppendorf Centrifuge 5804/5804 R and 5810/5810 R with their renowned quality and reliability offer you cost efficient solutions for your medium- throughput applications. Centrifuge 5804/5804 R is a high speed centrifuge for medium capacity needs. It allows for molecular biology applications in bottles up to 250 mL and offers additional swing-bucket and fixed-angle rotors as well as deepwell plate capacity for increased versatility. Centrifuge 5810/5810 R is a workhorse for medium throughput laboratories. It spins up to 28 conical tubes with 50 mL or 56 tubes with 15 mL.

Product features

- > Swing-bucket rotors and adapters accommodate tubes and bottles from 0.2 mL to 750 mL
- > Plate rotor for centrifugation of all types of MTP, PCR, cell culture, or Deepwell Plates
- > Fixed-angle rotors for high-speed applications in tubes from 0.2 mL to 85 mL
- > Centrifugation speed of up to $20,913 \times g$ (14,000 rpm)
- > Aerosol-tight Eppendorf QuickLock® caps and lids for easy, one-hand operation
- > Low access height of 29 cm for easy loading and unloading of samples
- > Compact footprint saves valuable bench space
- > Automatic rotor recognition and imbalance detection for maximum operational safety

Additional features of refrigerated Centrifuge 5804 R and 5810 R

- > Temperature range from $-9\text{ }^{\circ}\text{C}$ to $40\text{ }^{\circ}\text{C}$
- > FastTemp function for fast pre-cooling
- > Continuous cooling maintains a constant temperature after the run has been completed – your samples stay cool
- > ECO shut-off engages after 8 hours of non-use to reduce energy consumption and to extend compressor life

For more information go to www.eppendorf.com/centrifugation

Centrifuge 5804/5804 R and 5810/5810 R

Technical specifications				
Model	5804	5804 R	5810	5810 R
Max. RCF	20,913 × g	20,913 × g	20,913 × g	20,913 × g
Max. RCF with fixed-angle rotor	20,913 × g	20,913 × g	20,913 × g	20,913 × g
Max. RCF with swing-bucket rotor	4,500 × g	4,500 × g	4,500 × g	4,500 × g
Max. RCF with plate rotor	2,250 × g	2,250 × g	3,486 × g	3,486 × g
Max. speed	14,000 rpm	14,000 rpm	14,000 rpm	14,000 rpm
Speed	200 – 14,000 rpm	200 – 14,000 rpm	200 – 14,000 rpm	200 – 14,000 rpm
Max. capacity	4 × 250 mL/2 × 5 MTP	4 × 250 mL/2 × 5 MTP	4 × 750 mL/4 × 4 MTP	4 × 750 mL/4 × 4 MTP
Rotors available	12	12	18	18
Acceleration/braking ramps	10/10	10/10	10/10	10/10
Number of programs	35 user-defined programs	35 user-defined programs	35 user-defined programs	35 user-defined programs
Display	large, brightly lit LCD	large, brightly lit LCD	large, brightly lit LCD	large, brightly lit LCD
Timer	1 min to 99 min, with continuous run function, short-spin	1 min to 99 min, with continuous run function, short-spin	1 min to 99 min, with continuous run function, short-spin	1 min to 99 min, with continuous run function, short-spin
Noise level	< 62 dB(A)	< 58 dB(A)	< 70 dB(A)	< 56 dB(A)
Noise level				
Rotor FA-45-6-30 (6x50 mL)	<55 dB(A)	<54 dB(A)	<56 dB(A)	<55 dB(A)
Rotor S-4-104 (4x750 mL)	–	–	<59 dB(A)	<56 dB(A)
Rotor S-4-72 (4x250 mL)	<62 dB(A)	<58 dB(A)	–	–
Power supply	230 V, 50 – 60 Hz	230 V, 50 – 60 Hz	230 V, 50 – 60 Hz	230 V, 50 – 60 Hz
Max. power consumption	900 W	1,650 W	900 W	1,650 W
Dimensions (W × D × H)	47 × 55 × 34 cm	64 × 55 × 34 cm	54 × 61 × 35 cm	70 × 61 × 35 cm
Footprint (dimensions w/o front panel, WxD)	47 × 50 cm	64 × 50 cm	54 × 54 cm	70 × 54 cm
Height (with open lid)	74 cm	74 cm	80 cm	80 cm
Weight w/o accessories	55 kg	80 kg	68 kg	99 kg
Cooling	non-refrigerated	refrigerated	non-refrigerated	refrigerated
Temperature control range	–	-9 °C to 40 °C	–	-9 °C to 40 °C

Ordering information

Description	Order no.
Centrifuge 5804, non-refrigerated, without rotor, keypad, 230 V/50 – 60 Hz	5804 000 010
Centrifuge 5804 R, refrigerated, without rotor, keypad, 230 V/50 – 60 Hz	5805 000 010
Centrifuge 5810, non-refrigerated, without rotor, keypad, 230 V/50 – 60 Hz	5810 000 010
Centrifuge 5810 R, refrigerated, without rotor, keypad, 230 V/50 – 60 Hz	5811 000 015

✎ Ordering information for other voltage options begins on page 450

i For more information go to www.ependorf.com/centrifugation

Technical specifications subject to change.

Rolling Cabinet



Description

If space is a limited resource in your lab, Eppendorf's rolling cabinet can give you the freedom and flexibility to use your Centrifuge 5804/5804 R or 5810/5810 R wherever you need it. Use the rolling cabinet if there is not enough space on the regular lab bench or to transport and use the centrifuge in other labs. The included drawer provides extra storage space for your rotors and adapters.



Product features

- > Rolling cabinet with closed centrifuge fits under standard 90 cm lab benches
- > With 4 castors (2 lockable) and drawer
- > Dimensions (W × D × H): 70 × 62 × 45 cm



Ordering information

Description	Order no.
Rolling Cabinet, for Centrifuge 5804/5804 R and 5810/5810 R	5821 020 010

Your local distributor: www.ependorf.com/contact

Eppendorf AG · Barkhausenweg 1 · 22339 Hamburg · Germany · ependorf@ependorf.com · www.ependorf.com · www.ependorf.com/eshop

Centrifuge Packages



Description

Whether you need a refrigerated or non-refrigerated centrifuge for low, medium throughput applications, one of these packages will definitely suit your requirements.

Cell Culture Centrifuge packages include

- > Centrifuge 5702/5702 R, 5804/5804 R or 5810/5810 R
- > Swing-bucket rotor incl. buckets
- > Four adapters for 15 mL conical tubes (two sets of 2)
- > Four adapters for 50 mL conical tubes (two sets of 2)

Centrifuge packages for round-bottom tubes include

- > Centrifuge 5810/ 5810 R
- > Swing-bucket rotor S-4-104 incl. buckets
- > Four adapters for 13 mm (5/7 mL) round bottom tubes (two sets of 2)
- > Four adapters for 16 mm (10 mL) round bottom tubes (two sets of 2)

Eppendorf Conical Tubes 15 mL, 25 mL and 50 mL

The Eppendorf Conical Tubes are the optimal solution for sample preparation protocols in microbiology and molecular biology laboratories. Safe design and easy handling ensure best sample processing.

Premium USP class 6 raw material ensures

- > Highest sample integrity
- > High g-Safe® centrifugation stability
- > Optimal sample and pellet visibility

For more information go to chapter „tubes and plates“ on page 120

Centrifuge Packages	Number of vessels per adapter/rotor	
	15 mL conical	50 mL conical
5702/5702 R	2/8	1/4
5804/5804 R + Rotor A-4-44	4/16	1/4
5804/5804 R + Rotor S-4-72	8/32	4/16
5810/5810 R + Rotor A-4-62	9/36	4/16
5810/5810 R + Rotor A-4-81	12/48	5/20
5810/5810 R + Rotor S-4-104	14/56	7/28
	13 mm	16 mm
5810/5810 R + S-4-104	23/92	20/80

Ordering information

Description	Max. capacity per rotor	Order no.
Centrifuge 5702 , non-refrigerated, with Rotor A-4-38 incl. adapters for 15/50 mL conical tubes, 2 sets of 2 adapters, rotary knobs, 230 V/50 – 60 Hz	8 × 15 mL/4 × 50 mL	5702 000 320
Centrifuge 5702 R , refrigerated, with Rotor A-4-38 incl. adapters for 15/50 mL conical tubes, 2 sets of 2 adapters, rotary knobs, 230 V/50 – 60 Hz	8 × 15 mL/4 × 50 mL	5703 000 425
Centrifuge 5804 , non-refrigerated, with Rotor A-4-44 incl. adapters for 15/50 mL conical tubes, keypad, 230 V/50 – 60 Hz	16 × 15 mL/4 × 50 mL	5804 000 320
Centrifuge 5804 R , refrigerated, with Rotor A-4-44 incl. adapters for 15/50 mL conical tubes, keypad, 230 V/50 – 60 Hz	16 × 15 mL/4 × 50 mL	5805 000 320
Centrifuge 5804 , non-refrigerated, with Rotor S-4-72 incl. adapters for 15/50 mL conical tubes, keypad, 230 V/50 – 60 Hz	32 × 15 mL/16 × 50 mL	5804 000 520
Centrifuge 5804 R , refrigerated, with Rotor S-4-72 incl. adapters for 15/50 mL conical tubes, keypad, 230 V/50 – 60 Hz	32 × 15 mL/16 × 50 mL	5805 000 620
Centrifuge 5810 , non-refrigerated, with Rotor A-4-62 incl. adapters for 15/50 mL conical tubes, keypad, 230 V/50 – 60 Hz	36 × 15 mL/16 × 50 mL	5810 000 320
Centrifuge 5810 R , refrigerated, with Rotor A-4-62 incl. adapters for 15/50 mL conical tubes, keypad, 230 V/50 – 60 Hz	36 × 15 mL/16 × 50 mL	5811 000 325
Centrifuge 5810 , non-refrigerated, with Rotor A-4-81 incl. adapters for 15/50 mL conical tubes, keypad, 230 V/50 – 60 Hz	48 × 15 mL/20 × 50 mL	5810 000 420
Centrifuge 5810 R , refrigerated, with Rotor A-4-81 incl. adapters for 15/50 mL conical tubes, keypad, 230 V/50 – 60 Hz	48 × 15 mL/20 × 50 mL	5811 000 420
Centrifuge 5810 , non-refrigerated, with Rotor S-4-104 incl. adapters for 15/50 mL conical tubes, keypad, 230 V/50 – 60 Hz	56 × 15 mL/28 × 50 mL	5810 000 525
Centrifuge 5810 R , refrigerated, with Rotor S-4-104 incl. adapters for 15/50 mL conical tubes, keypad, 230 V/50 – 60 Hz	56 × 15 mL/28 × 50 mL	5811 000 620
Centrifuge 5810 , non-refrigerated, with Rotor S-4-104 incl. adapters for 13/16 mm round-bottom tubes, keypad, 230 V/50 – 60 Hz	92 × 13 mm/80 × 16 mm	5810 000 620
Centrifuge 5810 R , refrigerated, with Rotor S-4-104 incl. adapters for 13/16 mm round-bottom tubes, keypad, 230 V/50 – 60 Hz	92 × 13 mm/80 × 16 mm	5811 000 820

✎ Ordering information for other voltage options begins on page 450

Overview of Swing-Bucket Rotors 58xx Family



Model	Rotor S-4-104	Rotor A-4-81	Rotor A-4-62
Max. capacity 5804/5804 R	4 x 750 mL	4 x 500 mL	4 x 250 mL
5810/5810 R	■	■	■
Positioning	Medium capacity swing-bucket rotor for blood, bacteria, cell culture and plate centrifugation	Medium capacity swing-bucket rotor for blood, bacteria, cell culture and plate centrifugation	Economic swing-bucket rotor for blood, bacteria, cell culture and plate centrifugation
Aerosol-tightness tubes/plates	yes/yes	yes/no	yes/no
Max. RCF	3,214 x g	3,220 x g	3,220 x g
Max. speed	3,900 rpm	4,000 rpm	4,000 rpm
Eppendorf Tubes® 5.0 mL and 15 mL conical	56	48	36
25 mL snap cap tubes	24	20	12
25 mL screw cap tubes	28	20	12
50 mL conical tubes	28	20/28 ¹⁾	16
13 mm round-bottom and blood collection tubes	92	100	60
16 mm round-bottom and blood collection tubes	80	64	48
1.5/2.0 mL micro tube	200	80	64
PCR plates/MTP	16	16	16
Deepwell plates (DWP)	4	4	4

¹⁾ Maximum capacity with dedicated bucket/adaptor. ²⁾ Maximum capacity with dedicated 50 mL bucket.



Model	Rotor S-4-72	Rotor A-4-44	Rotor A-2-DWP-AT	Rotor A-2-DWP
Max. capacity	4 x 250 mL	4 x 100 mL	2 x 6 MTP	2 x 5 MTP
Positioning	Economic swing-bucket rotor for blood, bacteria, cell culture centrifugation	High-speed swing-bucket rotor for platelet poor plasma, blood, bacteria and cell culture	Aerosol-tight deepwell plate rotor for safe centrifugation of hazardous samples.	Economic deepwell plate rotor
Aerosol-tightness tubes/plates	no/-	yes/-	-/yes	-/no
Max. RCF	3,234 x g	4,500 x g	3,486 x g	2,250 x g
Max. speed	4,200 rpm	5,000 rpm	4,500 rpm	3,700 rpm
Eppendorf Tubes® 5.0 mL and 15 mL conical	32	16	-	-
25 mL snap cap tubes	16	4	-	-
25 mL screw cap tubes	16	4	-	-
50 mL conical tubes	16	4/8 ²⁾	-	-
13 mm round-bottom and blood collection tubes	56	36	-	-
16 mm round-bottom and blood collection tubes	52	28	-	-
1.5/2.0 mL micro tube	104	48	48	48
PCR plates/MTP	-	-	8	8
Deepwell plates (DWP)	-	-	4	4

Advanced Rotor Design – Swing-Bucket Rotors



Improved energy efficiency

The round buckets have been designed to be especially aerodynamic. The result is a more efficient design that reduces power consumption by up to 48 %.

Longer rotor lifetime

The second rotor generation of both swing-bucket and fixed-angle rotors has been designed with a longer lifetime in mind.

Product features

- > New Eppendorf QuickLock® caps for one-hand operation
- > Significantly improved handling, easy operation with one or two hands
- > Handle allows the closed bucket to be carried to the biosafety cabinet where it can be opened in a safe environment.
- > Aerosol-tightness has been tested and verified by Public Health England, Porton Down, UK



Mixed bucket loading

Rotors S-4-104 and A-4-81 allow for mixed loading with 2 plate buckets and 2 round/rectangular buckets. You can, for example, order the rotor with 4 rectangular/round buckets for tubes and, in addition, buy a set of 2 plate buckets. There is no need to buy a complete set of 4 plate buckets.

Overview of the Main Fixed-Angle Rotors 58xx Family



Model	Rotor F-34-6-38	Rotor FA-45-6-30
Max. capacity	6 × 85 mL	6 × 50 mL
5804/5804 R	■	■
5810/5810 R	■	■
Positioning	High-speed rotor suitable for molecular applications in tubes up to 85 mL	Aerosol-tight high-speed rotor for safe centrifugation of hazardous samples
Aerosol-tightness	no	yes
Max. RCF	18,514 × g	20,133 × g
Max. speed	12,000 rpm	12,000 rpm
1.5/2.0 mL micro tube	24	–
Eppendorf Tubes® 5.0 mL and 15 mL conical	6	6
50 mL conical tubes	6	6
25 mL conical tubes	6 ¹⁾²⁾	6 ²⁾³⁾
85 mL Oakridge®	6	–

¹⁾ Screw cap tubes only. ²⁾ Please order adapter for 25 mL conical tubes screw cap 5820 734 000. ³⁾ Please order adapter for 25 mL conical tubes snap cap 5820 733 004.

Advanced Rotor Design – Fixed-Angle Rotors



Low rotor weight

Eppendorf's fixed-angle rotors are among the lightest in the industry to improve handling and operational safety. Light-weight rotors cause less wear and tear on the motor and allow for faster acceleration and braking times.

Eppendorf QuickLock® lids for ergonomic lid locking

Our aerosol-tight QuickLock rotors close with only ¼ of a turn. This not only saves you time during every day use, it also takes repetitive stress off your wrist.

Superior temperature control

Aluminum, with its high heat conductivity, allows fast pre-cooling and accurate temperature control in refrigerated centrifuges.

Product features

- > All rotors are anodized for high chemical resistance and to prevent corrosion
- > Optimized design of rotor boreholes and adapters provide optimal support for high-speed centrifugation of tubes
- > Aluminum rotors are recyclable



Model	Rotor FA-45-20-17	Rotor FA-45-48-11	Rotor F-45-30-11/Rotor FA-45-30-11
Max. capacity	20 × 5.0 mL	48 × 1.5/2.0 mL	30 × 1.5/2.0 mL
Applications in Eppendorf Tubes® 5.0 mL	■	■	■
Applications in Eppendorf Tubes® 5.0 mL	yes	Aerosol-tight microcentrifuge tube rotor for safe centrifugation of hazardous samples	Micro centrifuge tube rotor
Aerosol-tightness	yes	yes	no/yes
Max. RCF	20,913 × g	19,083 × g	20,817 × g
Max. speed	13,100 rpm	13,000 rpm	14,000 rpm
1.5/2.0 mL micro tube	20	48	30
20/-	–	–	–
–	–	–	–
–	–	–	–
–	–	–	–

Ordering information

Description	Order no.
Rotor FA-45-20-17 , incl. rotor lid, for 20 × Eppendorf Tubes® 5.0 mL	5820 765 003
Adapter , for 1 vessel 1.5 – 2.0 mL, for all 5.0 mL rotors, set of 4 pcs.	5820 768 002
Adapter , for 1 cryo tube, for all 5.0 mL rotors, set of 4 pcs.	5820 769 009
Adapter , for 1 HPLC tube, for all 5.0 mL rotors, set of 4 pcs.	5820 770 007
Rotor FA-45-48-11 , incl. rotor lid, for 48 × 1.5/2.0 mL tubes	5820 760 001
Rotor F-45-30-11 , incl. rotor lid, for 30 × 1.5/2.0 mL reaction vessels	5804 715 004
Rotor FA-45-30-11 , incl. rotor lid, for 30 × 1.5/2.0 mL reaction vessels, aerosol-tight	5804 726 006

Rotors for 58xx Family



Model	Rotor F-35-48-17 ¹⁾	Rotor T-60-11	Rotor F-45-48-PCR
Max. capacity		60 × 1.5/2.0 mL	6 × 5/8 PCR strips (48 × 0.2 mL)
5804/5804 R	■	■	■
5810/5810 R	■	■	■
Aerosol-tightness	no	no	no
Max. RCF	5,005 × g	16,435 × g	15,294 × g
Max. speed	5,500 rpm	14,000 rpm	12,000 rpm
1.5/2.0 mL micro tube	–	60	–
Eppendorf Tubes® 5.0 mL and 15 mL conical	-/40	–	–

¹⁾ Please note that a software upgrade will be necessary for older centrifuges when using this rotor. Please contact your local Eppendorf organization or dealer for further information.

Ordering information

Description	Order no.
Rotor F-35-48-17, for 24 × 15 mL conical tubes, incl. 24 steel sleeves and adapters	5820 771 003
Rotor F-35-48-17, for 36 × 15 mL conical tubes, incl. 48 steel sleeves and adapters	5820 772 000
Rotor T-60-11, incl. rotor lid, for 1.5/2.0 mL tubes, without adapter	5804 730 003
Adapter, for 10 reaction vessels 1.5/2.0 mL, for Rotor T-60-11, set of 6 pcs.	5804 731 000
Adapter, for 20 reaction vessels 0.4 mL, for Rotor T-60-11, set of 6 pcs.	5804 732 006
Rotor F-45-48-PCR, for 6 × 8, 6 × 5 PCR tube strips, 48 × 0.2 mL individual PCR tubes	5804 735 005



Rotor A-2-DWP-AT

- > For use in Centrifuge 5810/5810 R only¹⁾
- > Max. speed: 3,486 × g (4,500 rpm)
- > Rotor can handle up to
 - 2 × 6 MTP
 - 2 × 2 DWP
 - 2 × 1 Filtration plate kits
- > Maximum loading height of 67 mm (89 mm without lid)
- > Rotor comes with aerosol-tight caps²⁾ for safe centrifugation of hazardous samples
- > Rotor and buckets are autoclavable (121 °C, 20 min)

¹⁾ Please note that a software upgrade may be necessary for older centrifuges when using Rotor A-2-DWP-AT. Please contact your local Eppendorf organization or dealer for further information. ²⁾ Aerosol-tightness tested by Public Health England, Porton Down, UK.

Ordering information

Description	Order no.
Rotor A-2-DWP-AT, incl. 2 buckets, 2 aerosol-tight caps and 2 plate carriers	5820 710 004



Adapter

- > PCR plate adapters are designed to support thin-walled PCR plate wells during centrifugation
- > Available for 96-well and 384-well PCR plates
- > Adapters can be used in all Eppendorf plate rotors

Cell culture flask adapter

- > Adapter to spin down cell cultures directly in a cell culture flask
- > Suitable for 25 cm² and selective 75 cm² flasks (please ask for details)
- > Adapters can be used in Eppendorf plate rotor A-4-81-MTP/Flex

IsoRack adapter

- > IsoRack adapters to support 0.5 mL and 1.5/2.0 mL IsoRacks during centrifugation
- > Adapters can be used in Eppendorf plate rotors A-2-DWP and A-4-81-MTP/Flex

Ordering information

Description	Order no.
Adapter, for 1 cell culture flask, for Rotors A-4-81-MTP/Flex	5825 719 000
Adapter, for 1 PCR plate (96 wells) PCR plate 96 wells, for plate rotors, set of 2 pcs.	5825 711 009
Adapter, for 1 PCR plate (384 wells) PCR plate 384 wells, for plate rotors, set of 2 pcs.	5825 713 001
Adapter, for 24 vessels in the IsoRack 0.5 mL, for Rotor A-4-81 (MTP), set of 2 pcs.	5825 708 008
Adapter, for 24 vessels in the IsoRack 1.5/2.0 mL, for Rotor A-4-81 (MTP), set of 2 pcs.	5825 709 004
CombiSlide Adapter, for 12 slides Combi Slide, for Rotors A-2-MTP and A-4-81 (MTP), set of 2 pcs.	5825 706 005



Rotor A-2-DWP

- > For use in Centrifuge 5804/5804 R and 5810/5810 R
- > Max. speed: 2,250 × g (3,700 rpm)
- > Rotor can handle up to
 - 2 × 5 MTP
 - 2 × 4 Cell culture plates
 - 2 × 2 DWP
 - 2 × 1 Filtration plate kits
- > Maximum loading height of 89 mm
- > Rotor and buckets are autoclavable (121 °C, 20 min)

Ordering information

Description	Order no.
Rotor A-2-DWP, rotor for Deepwell Plates incl. 2 buckets	5804 740 009



Rotors for Centrifuge 5810 and 5810 R



Rotor S-4-104

- > Medium capacity swing-bucket rotor with max. speed 3,214 × g (3,900 rpm)¹⁾
- > Broad range of adapters enables high versatility for tubes and bottles from 0.2 mL to 750 mL and plates
- > Aerodynamic round bucket design for up to 36 % energy savings compared to Rotor A-4-81
- > Mixed loading with 2 plate buckets and 2 round tube buckets allows for increased versatility
- > Aerosol-tight QuickLock caps for safe centrifugation of hazardous samples optionally available²⁾
- > Buckets, lids and adapters are autoclavable (121 °C, 20 min)

¹⁾ Please note that a software upgrade will be necessary for older centrifuges when using this rotor. Please contact your local Eppendorf organization or dealer for further information. ²⁾ Aerosol-tightness tested by Public Health England, Porton Down, UK.

Adapters for Rotor S-4-104							
Tube Volume	1.5/2.0 mL	12 × 75 mm, 5 mL FACS	2.6 – 8 mL	5.5 – 12 mL	9 mL	14 mL	Eppendorf Tubes® 5.0 mL and 15 mL conical
Max. tube diameter	11 mm	12 mm	13 mm	16 mm	17.5 mm	17.5 mm	17 mm
Max. vessel height	39 mm	115 mm	115 mm	119 mm	111 mm	117 mm	125 mm
Max. vessel height for use with cap/lid¹⁾	39 mm	108 mm	108 mm	114 mm	106 mm	112 mm	121 mm
Adapter							
Number of vessels per adapter/rotor	50/200	27/108	23/92	20/80	20/80	14/56	14/56
Bottom shape	flat	round	round	round	round	round	conical
Centrifugation radius	188 mm	183 mm	179 mm	180 mm	179 mm	185 mm	188 mm
Max. RCF	3,197 × g	3,112 × g	3,044 × g	3,061 × g	3,044 × g	3,146 × g	3,197 × g
Packing	set of 2 pcs.	set of 2 pcs.	set of 2 pcs.	set of 2 pcs.	set of 2 pcs.	set of 2 pcs.	set of 2 pcs.
Order no.	5825 740 009	5825 747 003	5825 738 004	5825 736 001	5825 743 008	5825 748 000	5825 734 009

¹⁾ Exceeding the maximum tube length may reduce the loading capacity of the rotor. Please perform a manual swing-out test before starting the centrifuge run to make sure the tubes do not hit the rotor yoke.

²⁾ Please order adapter for 25 mL conical tubes snap cap 5820 733 004. ³⁾ Please order adapter for 25 mL conical tubes screw cap 5820 734 000. ⁴⁾ Please note that these conical bottles need to be used together with a conical form insert provided by the manufacturer. ⁵⁾ 225 mL conical bottles from BD[®]/Corning[®] and 250 mL conical bottles from Nunc[®] for Rotor S-4-104.

Ordering information

Description	Order no.
Rotor S-4-104	
incl. 4 × 750 mL round buckets	5820 740 000
incl. 4 plate buckets (aerosol-tight capable)	5820 754 001
without buckets	5820 755 008
Plate bucket (aerosol-tight capable) , for Rotor S-4-104, incl. plate carrier, set of 2 pcs.	5820 744 006
Plate bucket (aerosol-tight capable) , for Rotor S-4-104, incl. plate carrier, set of 4 pcs.	5820 743 000
Bucket 750 mL , for Rotor S-4-104, set of 2 pcs.	5820 742 003
Bucket 750 mL , for Rotor S-4-104, set of 4 pcs.	5820 741 007
Caps for plate buckets (aerosol-tight capable) , aerosol-tight, for Rotor S-4-104 and Rotor S-4x750, set of 2 pcs.	5820 748 001
Caps for 750 mL round buckets , aerosol-tight, for Rotor S-4-104, Rotor S-4x750 and Rotor S-4x1000, set of 2 pcs.	5820 747 005
Wide-neck bottle 750 mL , for Rotor S-4-104, S-4x750, S-4x1000, set of 2 pcs.	5820 708 000

25 mL snap cap ²⁾	25 mL screw cap ³⁾	50 mL conical	50 mL conical, skirted	250 mL flat, 175 – 225/250 mL conical ⁴⁾⁵⁾	500 mL Corning [®]	750 mL	MTP, DWP, PCR plates
39 mm	29.8 mm	30 mm	30 mm	62 mm	96 mm	102 mm	–
83 mm	78.5 mm	122 mm	120 mm	145 mm	147 mm	140 mm	60 mm
83 mm	78.5 mm	116 mm	116 mm	125 mm	–	–	47 mm
6/24	7/28	7/28	5/20	1/4	1/4	1/4	4/16 (MTP) 1/4 (DWP)
conical	conical	conical	conical	flat	conical	flat	flat
161 mm	151 mm	187 mm	178 mm	183 mm	187 mm	185 mm	151 mm
2,737 × g	2,567 × g	3,180 × g	3,027 × g	3,112 × g	3,146 × g	3,146 × g	2,568 × g
set of 2 pcs.	set of 2 pcs.	set of 2 pcs.	set of 2 pcs.	set of 2 pcs.	set of 2 pcs.	set of 2 pcs.	set of 2 pcs.
5825 733 002	5825 733 002	5825 733 002	5825 732 006	5825 741 005	5825 745 000	5825 744 004	5820 744 006



Rotors for Centrifuge 5810 and 5810 R



Rotor A-4-81

- > Swing-bucket rotor with max. speed 3,220 × g (4,000 rpm)
- > Rotor A-4-81 accommodates tubes and bottles from 0.2 mL to 500 mL as well as plates
- > Aerosol-tight caps¹⁾ for safe centrifugation of hazardous samples optionally available
- > Mixed loading with 2 plate buckets and 2 rectangular tube buckets allows for increased versatility
- > Buckets, caps and adapters are autoclavable (121 °C, 20 min)

¹⁾ Aerosol-tightness tested by Public Health England, Porton Down, UK.

Adapters for Rotor A-4-81								
Tube Volume	1.5/2.0 mL	1.2 – 5 mL	2.6 – 5 mL	2.6 – 7 mL	3 – 15 mL	7 – 17 mL	Eppendorf Tubes® 5.0 mL and 15 mL conical tubes	25 mL snap cap
Max. tube diameter	11 mm	11 mm	13 mm	13 mm	16 mm	17.5 mm	17.5 mm	39 mm
Max. vessel height	43 mm	108 mm	108 mm	108 mm	108 mm	118 mm	121 mm	83 mm
Max. vessel height for use with cap/lid¹⁾	43 mm	108 mm	107 mm	108 mm	108 mm	118 mm	121 mm	83 mm
Adapter								
Number of vessels per adapter/rotor	20/80	20/80	25/100	18/72	16/64	16/64	12/48	5/20
Bottom shape	flat	flat	flat with rubber mat	flat with rubber mat	flat with rubber mat	flat with rubber mat	conical	conical
Centrifugation radius	165 mm	168 mm	168 mm	168 mm	168 mm	168 mm	173 mm	158 mm
Max. RCF	2,950 × g	3,000 × g	3,000 × g	3,000 × g	3,000 × g	3,000 × g	3,100 × g	2,826 × g
Packing	set of 2 pcs.	set of 2 pcs.	set of 2 pcs.	set of 2 pcs.	set of 2 pcs.	set of 2 pcs.	set of 2 pcs.	set of 2 pcs.
Order no.	5810 745 004	5810 746 000	5810 720 001	5810 747 007	5810 748 003	5810 721 008	5810 722 004	5810 723 000

¹⁾ Exceeding the maximum tube length may reduce the loading capacity of the rotor. Please perform a manual swing-out test before starting the centrifuge run to make sure the tubes do not hit the rotor yoke.

²⁾ Please order adapter for 25 mL conical tubes snap cap 5820 733 004. ³⁾ Please order adapter for 25 mL conical tubes screw cap 5820 734 000. ⁴⁾ Please order adapter for 50 mL conical tubes skirted 5804 737 008.

Ordering information

Description	Order no.
Rotor A-4-81 , incl. 4 x 500 mL rectangular buckets	5810 718 007
Rotor A-4-81 , without buckets	5810 743 001
Rotor A-4-81 , with 4 MTP/Flex buckets	5810 725 003
Bucket 500 mL rectangular , for Rotor A-4-81, set of 4 pcs.	5810 730 007
Bucket for 7 x 50 mL conical tubes , for Rotor A-4-81, set of 4 pcs.	5825 730 003
Lid , aerosol-tight, for 500 mL rectangular bucket, set of 2 pcs.	5810 724 007
Wide-neck bottle 500 mL , for Rotor A-4-81 and Rotor S-4x500, square, set of 2 pcs.	5820 707 003
Wide-neck bottle 400 mL , for Rotor A-4-81 and Rotor S-4x500, set of 2 pcs.	5810 729 009
MTP/Flex bucket , for Rotor A-4-81 and Rotor S-4x500, set of 2 pcs.	5810 742 005
MTP/Flex bucket , for Rotor A-4-81 and Rotor S-4x500, set of 4 pcs.	5810 741 009

25 mL snap cap ²⁾	25 mL screw cap	25 mL screw cap ³⁾	50 mL conical	50 mL conical	30 – 50 mL and 50 mL conical tubes, skirted ⁴⁾	180 – 250 mL flat/175 – 225 mL conical	400 mL	500 mL	MTP, DWP, PCR plates
39 mm	29.8 mm	29.8 mm	30 mm	30 mm	30 mm	62 mm	133 mm	83 mm	–
83 mm	78.5 mm	78.5 mm	122 mm	122 mm	121 mm	133 mm	133 mm	134 mm	60 mm
83 mm	78.5 mm	78.5 mm	–	116 mm	–	–	–	134 mm	–
7/28	5/20	7/28	7/28	5/20	5/20	1/4	1/4	–/4	4/16 (MTP) 1/4 (DWP)
conical	conical	conical	conical	conical	flat with rubber mat	flat with rubber mat	flat, rubber	flat	flat with rubber mat
155 mm	148 mm	145 mm	180 mm	173 mm	173 mm	173 mm	180 mm	180 mm	163 mm
2,772 × g	2,647 × g	2,593 × g	3,220 × g	3,100 × g	3,100 × g	3,100 × g	3,220 × g	3,220 × g	2 900 × g
set of 4 pcs.	set of 2 pcs.	set of 4 pcs.	set of 4 pcs.	set of 2 pcs.	set of 2 pcs.	set of 2 pcs.	set of 2 pcs.	–	set of 2 pcs.
5825 730 003	5810 723 000	5825 730 003	5825 730 003	5810 723 000	5810 739 004	5825 722 000	5810 728 002	–	5810 742 005

Rotors for Centrifuge 5810 and 5810 R



Rotor A-4-62

- > Swing-bucket rotor with max. speed 3,220 × g (4,000 rpm)
- > Rotor A-4-62 accommodates tubes and bottles from 0.2 mL to 250 mL as well as plates
- > Aerosol-tight caps¹⁾ for safe centrifugation of hazardous samples optionally available
- > Rotor, buckets, caps and adapters are autoclavable (121 °C, 20 min)

¹⁾ Aerosol-tightness tested by Public Health England, Porton Down, UK.

Ordering information

Description	Order no.
Rotor A-4-62 , incl. 4 × 250 mL rectangular buckets	5810 709 008
Rotor A-4-62 , with 4 MTP buckets	5810 711 002
MTP bucket , for Rotor A-4-62-MTP, for 4 MTP or 1 DWP, set of 4 pcs.	5810 702 003
Caps , aerosol-tight, for rectangular bucket 250 mL, set of 2 pcs.	5810 710 006
Rectangular bucket 250 mL , for Rotor A-4-62, 4 pieces	5810 716 004

Adapters for Rotor A-4-62								
Tube Volume	1.5 – 2.0 mL	1.2 – 5 mL	2.6 – 7 mL	3 – 15 mL	7 – 17 mL	Eppendorf Tubes® 5.0 mL and 15 mL conical	7 – 18 mL	18 – 25 mL
Max. tube diameter	11 mm	11 mm	13 mm	16 mm	17.5 mm	17.5 mm	20 mm	26 mm
Max. vessel height	43 mm	123 mm	121 mm	121 mm	118 mm	127 mm	126 mm	119 mm
Max. vessel height for use with cap/lid¹⁾	43 mm	115 mm	118 mm	116 mm	114 mm	121 mm	119 mm	116 mm
Adapter								
Number of vessels per adapter/rotor	16/64	25/100	15/60	12/48	12/48	9/36	8/32	4/16
Bottom shape	flat	flat with rubber mat	flat with rubber mat	flat with rubber mat	flat with rubber mat	conical	flat with rubber mat	flat with rubber mat
Centrifugation radius	171 mm	173 mm	173 mm	173 mm	173 mm	178 mm	173 mm	173 mm
Max. RCF	3,000 × g	3,050 × g	3,050 × g	3,050 × g	3,050 × g	3,150 × g	3,050 × g	3,050 × g
Packing	set of 2 pcs.	set of 2 pcs.	set of 2 pcs.	set of 2 pcs.	set of 2 pcs.	set of 2 pcs.	set of 2 pcs.	set of 2 pcs.
Order no.	5810 751 004	5810 750 008	5810 752 000	5810 753 007	5810 754 003	5810 755 000	5810 756 006	5810 757 002

¹⁾ Exceeding the maximum tube length may reduce the loading capacity of the rotor. Please perform a manual swing-out test before starting the centrifuge run to make sure the tubes do not hit the rotor yoke.
²⁾ Please order adapter for 50 mL conical tubes skirted 5804 737.008.

25 mL snap cap	25 mL screw cap	30 – 50 mL round-bottom/ 50 mL conical, skirted ²⁾	50 mL conical	50 mL conical	50 – 75 mL	80 – 120 mL	200 – 250 mL flat/ 175 – 225 mL conical	MTP, DWP, PCR plates
39 mm	29.8 mm	30 mm	30 mm	30 mm	35 mm	45 mm	62 mm	–
83 mm	78.5 mm	115 mm	122 mm	122 mm	122 mm	138 mm	136 mm	53 mm
83 mm	78.5 mm	–	–	116 mm	118 mm	125 mm	127 mm	–
3/12	3/12	4/16	4/16	3/12	2/8	1/4	1/4	4/16 (MTP) 1/4 (DWP)
conical	conical	flat with rubber mat	flat with conical inlay	conical	flat with rubber mat	flat with rubber mat	flat with rubber mat	flat with rubber mat
151 mm	141 mm	173 mm	173 mm	178 mm	173 mm	173 mm	180 mm	154 mm
2,701 × g	2,522 × g	3,050 × g	3,050 × g	3,150 × g	3,050 × g	3,050 × g	3,220 × g	2 750 × g
set of 2 pcs.	set of 2 pcs.	set of 2 pcs.	set of 2 pcs.	set of 2 pcs.	set of 2 pcs.	set of 2 pcs.	set of 2 pcs.	set of 4 pcs.
5810 758 009	5810 758 009	5810 759 005	5810 763 002	5810 758 009	5810 760 003	5810 761 000	5810 770 009	5810 702 003



Rotors for 58xx Family



Rotor S-4-72

- > Medium capacity swing-bucket rotor with speed up to $3,234 \times g$ (4,200 rpm)¹⁾
- > Broad range of adapters available to handle all common tube formats from 0.2 mL to 250 mL
- > Aerodynamic round bucket design for up to 48 % energy savings compared to Rotor A-4-62
- > Buckets and adapters are autoclavable (121 °C, 20 min)

¹⁾ Please note that a software upgrade will be necessary for older centrifuges when using this rotor. Please contact your local Eppendorf organization or dealer for further information.

Adapters for Rotor S-4-72					
Tube Volume	1.5/2.0 mL	2.6 – 8 mL	5.5 – 12 mL	9 mL	Eppendorf Tubes® 5.0 mL
Max. tube diameter	11 mm	13 mm	16 mm	17.5 mm	17 mm
Max. vessel height	43 mm	115 mm	112 mm	113 mm	60 mm
Adapter					
Number of vessels per adapter/rotor	26/104	14/56	13/52	12/48	8/32 ¹⁾
Bottom shape	flat	round	round	round	conical
Centrifugation radius	159 mm	159 mm	157 mm	158 mm	163 mm
Max. RCF	$3,136 \times g$	$3,136 \times g$	$3,096 \times g$	$3,116 \times g$	$3,215 \times g$
Packing	set of 2 pcs.	set of 2 pcs.	set of 2 pcs.	set of 2 pcs.	set of 2 pcs.
Order no.	5804 794 001	5804 789 008	5804 791 002	5804 792 009	5804 793 005

¹⁾ For Eppendorf Tubes® 5.0 mL with screw cap the capacity is limited to 6 tubes per adapter.²⁾ Please order adapter for 25 mL conical tubes snap cap 5820 733 004.³⁾ Please order adapter for 25 mL conical tubes screw cap 5820 734 000.⁴⁾ Please note that these conical bottles need to be used together with a conical form insert provided by the manufacturer.

Ordering information

Description	Order no.
Rotor S-4-72 , incl. 4 x 250 mL round buckets	5804 746 007

15 mL conical	25 mL snap cap ²⁾	25 mL screw cap ³⁾	50 mL conical	50 mL conical, skirted	250 mL flat/ 175 mL Falcon ⁴⁾
17 mm	39 mm	29.8 mm	30 mm	30 mm	62 mm
120 mm	83 mm	78.5 mm	120 mm	120 mm	130 mm
8/32	4/16	4/16	4/16	2/8	1/4
conical	conical	conical	conical	conical	flat
164 mm	137 mm	128 mm	164 mm	153 mm	160 mm
$3,234 \times g$	$2,701 \times g$	$2,524 \times g$	$3,234 \times g$	$2,602 \times g$	$3,155 \times g$
set of 2 pcs.	set of 2 pcs.	set of 2 pcs.	set of 2 pcs.	set of 2 pcs.	set of 2 pcs.
5804 783 000	5804 784 006	5804 784 006	5804 784 006	5804 785 002	5804 787 005



Rotors for 58xx Family



Rotor A-4-44

- > High-speed swing-bucket rotor for applications up to 4,500 × g (5,000 rpm)
- > Rotor A-4-44 accommodates tubes from 0.2 mL to 100 mL
- > Aerosol-tight caps¹⁾ for safe centrifugation of hazardous samples optionally available
- > Rotor, buckets, caps and adapters are autoclavable (121 °C, 20 min)

¹⁾ Aerosol-tightness tested by Public Health England, Porton Down, UK.

Adapters for Rotor A-4-44									
Tube Volume	1.5 – 2.0 mL	1.2 – 5 mL	2.6 – 7 mL	3 – 15 mL	7 – 17 mL	Eppendorf Tubes® 5.0 mL and 15 mL conical	15 mL conical	7 – 18 mL	18 – 30 mL
Max. tube diameter	11 mm	11 mm	13 mm	16 mm	17.5 mm	17.5 mm	17.5 mm	20 mm	26 mm
Max. vessel height	43 mm	105 mm	108 mm	108 mm	110 mm	121 mm	121 mm	107 mm	110 mm
Max. vessel height for use with cap/lid¹⁾	43 mm	102 mm	106 mm	106 mm	106 mm	–	121 mm	104 mm	100 mm
Adapter									
Number of vessels per adapter/rotor	12/48	14/56	9/36	7/28	6/24	4/16	2/8	4/16	2/8
Bottom shape	flat	flat with rubber mat	flat with rubber mat	flat with rubber mat	flat with rubber mat	conical	conical	flat with rubber mat	flat with rubber mat
Centrifugation radius	148 mm	150 mm	150 mm	150 mm	150 mm	155 mm	157 mm	150 mm	150 mm
Max. RCF	4,100 × g	4,200 × g	4,200 × g	4,200 × g	4,200 × g	4,332 × g	4,388 × g	4,200 × g	4,200 × g
Packing	set of 2 pcs.	set of 2 pcs.	set of 2 pcs.	set of 2 pcs.	set of 2 pcs.	set of 2 pcs.	set of 2 pcs.	set of 2 pcs.	set of 2 pcs.
Order no.	5804 751 000	5804 750 004	5804 752 007	5804 753 003	5804 754 000	5804 755 006	5804 717 007	5804 756 002	5804 757 009

¹⁾ Exceeding the maximum tube length may reduce the loading capacity of the rotor. Please perform a manual swing-out test before starting the centrifuge run to make sure the tubes do not hit the rotor yoke.

²⁾ Please order adapter for 25 mL conical tubes snap cap 5820 733 004. ³⁾ Please order adapter for 25 mL conical tubes screw cap 5820 734 000. ⁴⁾ Reordering of 50 mL form inserts: 5804 728.009. ⁵⁾ Please order adapter for 50 mL conical tubes skirted 5804 737.008.

Ordering information

Description	Order no.
Rotor A-4-44 , incl. 4 rectangular buckets 100 mL	5804 709 004
Rotor A-4-44 , incl. 4 buckets for 2 × 50 mL conical tubes	5804 719 000
Bucket for 2 × 50 mL conical tubes , for Rotor A-4-44, set of 4 pcs.	5804 706 005
Rectangular bucket 100 mL , for Rotor A-4-44, set of 4 pcs.	5804 741 005
Caps , aerosol-tight, for rectangular bucket 100 mL, set of 2 pcs.	5804 712 005
Adapter , for 50 mL conical tubes with skirted bottom, set of 8 pieces	5804 737 008

25 mL snap cap	25 mL snap cap ²⁾	25 mL screw cap	25 mL screw cap ³⁾	50 mL ⁴⁾ conical	50 mL conical	50 mL conical	30 – 50 mL round-bottom/ 50 mL conical, skirted ⁵⁾	50 – 75 mL	80 – 100 mL
39 mm	39 mm	29.8 mm	29.8 mm	–	31 mm	31 mm	31 mm	35 mm	45 mm
83 mm	83 mm	78.5 mm	78.5 mm	120 mm	122 mm	122 mm	122 mm	119 mm	114 mm
83 mm	83 mm	78.5 mm	78.5 mm	–	–	119 mm	108 mm	108 mm	100 mm
1/4	1/4	1/4	1/4	–/8	1/4	1/4	1/4	1/4	1/4
conical	conical	conical	conical	flat with conical inlay	conical	conical	flat with rubber mat	flat with rubber mat	flat with rubber mat
124 mm	126 mm	114 mm	116 mm	161 mm	155 mm	157 mm	150 mm	150 mm	150 mm
3,465 × g	3,521 × g	3,186 × g	3,242 × g	4,500 × g	4,332 × g	4,388 × g	4,200 × g	4,200 × g	4,200 × g
set of 2 pcs.	set of 2 pcs.	set of 2 pcs.	set of 2 pcs.	set of 4 pcs.	set of 2 pcs.	set of 2 pcs.	set of 2 pcs.	set of 2 pcs.	set of 2 pcs.
5804 758 005	5804 718 003	5804 758 005	5804 718 003	5804 706 005	5804 758 005	5804 718 003	5804 759 001	5804 760 000	5804 761 006









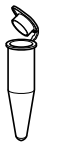

Rotors for 58xx Family



Rotor F-34-6-38

- > High-speed rotor for molecular applications in tubes from 0.2 mL to 85 mL
- > Max. speed: 18,514 × g (12,000 rpm) in Centrifuge 5810 R or 15,557 × g (11,000 rpm) in 5804/5804 R/5810¹⁾
- > Low rotor weight (3.2 kg) for easy handling
- > 34° borehole angle reduces pellet smears along tube wall
- > Anodized aluminum for high chemical resistance
- > Rotor, lid and adapters are autoclavable (121 °C, 20 min)

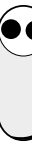
¹⁾ Rotors F-34-6-38 and FA-45-6-30 maintain 4 °C at 11,000 rpm











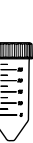

					
Adapters for Rotor F-34-6-38					
Tube Volume	1.5 – 2.0 mL	2.6 – 7 mL (13x75 mm)	2.6 – 7 mL (13x100 mm)	7 – 15 mL	Eppendorf Tubes® 5.0 mL
Max. tube diameter	11 mm	13 mm	13 mm	16 mm	17 mm
Max. vessel height					
Max. vessel height for use with cap/lid	110 mm	90 mm	110 mm	112 mm	104 mm
Adapter					
Number of vessels per adapter/rotor	4/24	3/18	3/18	2/12	1/6
Bottom shape	round	flat	flat	round	conical
Centrifugation radius	113 mm	106 mm	114 mm	112 mm	105 mm
Max. RCF at 12.100 rpm (5810 R)	18,200 × g	17,065 × g	18,353 × g	18,000 × g	17,187 × g
Max. RCF at 11.000 rpm (5804, 5804 R, 5810)	15,300 × g	14,339 × g	15,422 × g	15,150 × g	14,204 × g
Packing	set of 2 pcs.	set of 2 pcs.	set of 2 pcs.	set of 2 pcs.	set of 2 pcs.
Order no.	5804 770 005	5804 738 004	5804 739 000	5804 771 001	5804 777 000

¹⁾ Please order adapter for 25 mL conical tubes screw cap 5820 734 000.

For more information go to www.eppendorf.com/centrifugation

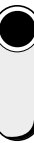
Ordering information

Description	Order no.
Rotor F-34-6-38, for 6 × 85 mL tubes, incl. rotor lid	5804 727 002

						
15 mL conical	15 – 18 mL	20 – 30 mL	25 mL screw cap ¹⁾	50 mL	50 mL conical	85 mL
17 mm	18 mm	26 mm	29.8 mm	29 mm	30 mm	38 mm
123 mm	123 mm	123 mm	78.5 mm	123 mm	121 mm	121 mm
						—
1/6	1/6	1/6	1/4	1/6	1/6	—/6
conical	round	round	conical	round	conical	round
107 mm	109 mm	110 mm	87 mm	112 mm	108 mm	115 mm
17,200 × g	17,550 × g	17,700 × g	—	18,014 × g	17,400 × g	18,500 × g
14,450 × g	14,750 × g	14,900 × g	14,070 × g	15,157 × g	14,600 × g	15,550 × g
set of 2 pcs.	set of 2 pcs.	set of 2 pcs.	set of 2 pcs.	set of 2 pcs.	set of 2 pcs.	—
5804 776 003	5804 772 008	5804 773 004	5804 775 007	5804 774 000	5804 775 007	—

Rotors for 58xx Family



Rotor FA-45-6-30

- > High-speed rotor for applications in tubes from 5 – 50 mL¹⁾
- > Max. speed 20,133 × g (12,100 rpm) in Centrifuge 5810 R or 16,639 × g (11,000 rpm) in 5804/5804 R/5810²⁾
- > Eppendorf QuickLock® rotor lid for fast lid locking
- > Aerosol-tight³⁾ for safe centrifugation of hazardous samples
- > Low rotor weight (3.2 kg) for easy lifting
- > Anodized aluminum for high chemical resistance
- > 45° borehole angle minimizes pellets smear
- > Rotor, lid and adapters are autoclavable (121 °C, 20 min)

¹⁾ Please note that a software upgrade may be necessary for older centrifuges when using this rotor. Please contact your local Eppendorf organization or dealer for further information.

²⁾ Rotors F-34-6-38 and FA-45-6-30 maintain 4 °C at 11,000 rpm

³⁾ Aerosol-tightness tested by Public Health England, Porton Down, Great Britain

Ordering information

Description	Order no.
Rotor FA-45-6-30, incl. rotor lid, for 6 × 15/50 mL conical tubes	5820 715 006

Adapters for Rotor FA-45-6-30

Tube Volume	2.6 – 5 mL	4 – 8 mL	5.5 – 10 mL	7.5 – 12 mL	Eppendorf Tubes® 5.0 mL
Max. tube diameter	13 mm	13 mm	16 mm	16 mm	17 mm
Max. vessel height for use with cap/lid	119 mm	119 mm	119 mm	119 mm	121 mm
Adapter					
Number of vessels per adapter/rotor	1/6	1/6	1/6	1/6	1/6 ¹⁾
Bottom shape	round	round	round	round	conical
Centrifugation radius	120 mm	120 mm	120 mm	120 mm	121 mm
Max. RCF at 12.100 rpm (5810 R)	19,642 × g	19,642 × g	19,642 × g	19,642 × g	19,806 × g
Max. RCF at 11.000 rpm (5804, 5804 R, 5810)	16,233 × g	16,233 × g	16,233 × g	16,233 × g	16,369 × g
Packing	set of 2 pcs.	set of 2 pcs.	set of 2 pcs.	set of 2 pcs.	set of 2 pcs.
Order no.	5820 726 008	5820 725 001	5820 728 000	5820 727 004	5820 730 005

¹⁾ Eppendorf Tubes® 5.0 mL with screw cap will not fit in this adapter.

Eppendorf Conical Tubes

Whether centrifugation, mixing, or other applications – the Eppendorf Conical Tubes 15 mL, 25 mL and 50 mL will perfectly fit into your workflows. They represent the next step in Eppendorf's comprehensive system solutions in liquid, sample and cell handling.

More information: www.eppendorf.com/conicals



7 – 17 mL	15 mL	15 – 18 mL	20 – 30 mL	25 mL snap cap	25 mL screw cap	50 mL conical
17.5 mm	17 mm	18 mm	26 mm	39 mm	29.8 mm	30 mm
122 mm	125 mm	125 mm	125 mm	83 mm	78.5 mm	121 mm
1/6	1/6	1/6	1/6	1/6	1/6	-/6
round	conical	round	round	conical	conical	conical
120 mm	120 mm	120 mm	105 mm	104 mm	97 mm	123 mm
19,642 × g	19,642 × g	19,642 × g	17,187 × g	17,023 × g	15,616 × g	20,133 × g
16,233 × g	16,223 × g	16,223 × g	14,204 × g	14,069 × g	13,122 × g	16,639 × g
set of 2 pcs.	set of 2 pcs.	set of 2 pcs.	set of 2 pcs.	set of 6 pcs.	set of 6 pcs.	-
5820 729 007	5820 717 009	5820 720 000	5820 721 006	5820 733 004	5820 734 000	-

Centrifuge 5910 R and Centrifuge 5920 R

Whether you choose the new Centrifuge 5910 R with great versatility or the well established Centrifuge 5920 R with more capacity, both instruments follow the same extremely high Eppendorf standards in temperature management and safety.

Advanced temperature management

Eppendorf developed the Dynamic Compressor Control (DCC). Unlike other compressors which switch back and forth between 0 % and 100 % performance output, DCC allows for a constant and smooth temperature regulation. This results in a precise cooling performance and the set temperature is kept stable at all time.

In addition to the well-known FastTemp function for super fast pre-cooling, both instruments include the new FastTemp pro® software option. This feature allows for automated pre-cooling based on pre-programmable time and date. Simply turn the centrifuge into standby mode when you leave your lab and let FastTemp pro take care of pre-cooling in the morning so you don't have to. This saves you more than 90 % of energy over night and programming is super easy.

Centrifuge 5920 R: Energy saving overnight with ECO shut-off and FastTemp pro®

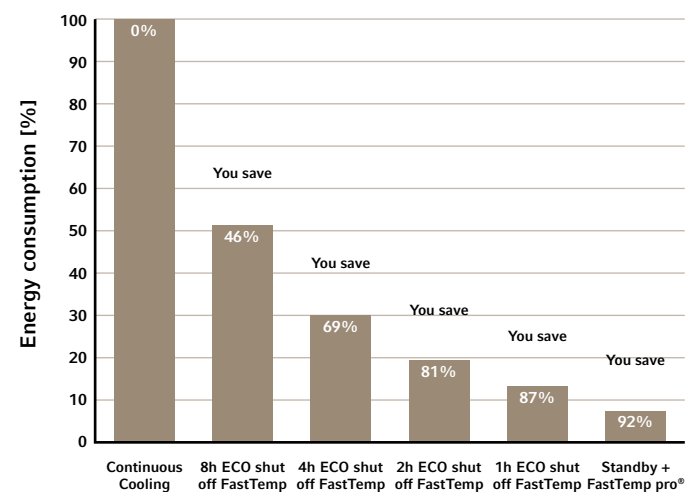

	Centrifuge 5910 R	Centrifuge 5920 R
1,000 mL Eppendorf bottles	4	–
1,000 mL standard bottles	–	4
750 mL bottles	4	4
180 – 250 mL bottles (flat)	4	8
50 mL conical tubes	36	52
25 mL conical tubes	36	52
5 mL and 15 mL conical tubes	68	108
1.5/2.0 mL Eppendorf Tubes®	200	368
BD Vacutainer® CPT™ (16 mm x 125 mm/8 mL)	28	80
16 mm round-bottom and blood collection tubes	104	148
13 mm round-bottom and blood collection tubes	120	196
PCR plates/MTP	20/4	28/8
Universal adapters for conical tubes, plates and bottles	■	–
Dual use of plates and tubes in one rotor bucket	■	■
Plate rotor options for MTP, PCR or DWP	■	■
Fixed-angle rotors for high-speed applications	■	■

Ordering information

Description	Order no.
Centrifuge 5910 R, refrigerated, without rotor, 230 V/50 – 60 Hz	5942 000 010
Centrifuge 5920 R, refrigerated, without rotor, 230 V/50 – 60 Hz	5948 000 010

✂ Ordering information for other voltage options begins on page 450

Innovative safety features

Centrifuge 5910 R and Centrifuge 5920 R have an automatic rotor recognition. This feature detects a newly inserted rotor and automatically limits the centrifuge speed to the rotor's maximum permissible value.

When handling substances that pose a health hazard it is highly recommended to use aerosol-tight fixed-angle rotors with Eppendorf QuickLock® lids or swing-bucket rotors in combination with Eppendorf QuickLock® caps.



Technical specifications

	Centrifuge 5910 R	Centrifuge 5920 R
Model	Centrifuge 5910 R	Centrifuge 5920 R
Max. RCF	22,132 × g	21,194 × g
Max. RCF with fixed-angle rotor	22,132 × g	21,194 × g
Max. RCF with swing-bucket rotor	5,263 × g	4,791 × g
Max. speed	14,000 rpm	13,700 rpm
Speed	100 – 14,000 rpm	100 – 13,700 rpm
Max. capacity	4 × 1,000 mL/4 × 5 MTP	4 × 1,000 mL/4 × 7 MTP
Acceleration/braking ramps	10/10	10/10
Number of programs	99 (5 program keys)	99 (5 program keys)
Display	large, brightly lit LCD	large, brightly lit LCD
Timer	10 s to 99 h 59 min, with continuous run function, short-spin	10 s to 99 h 59 min, with continuous run function, short-spin
Noise level		
Rotor FA-6x50	<59 dB(A)	<60 dB(A)
Rotor S-4x750	<57 dB(A)	
Rotor S-4xUniversal	<53 dB(A)	
Rotor S-4xUniversal-Large		<55 dB(A)
Power supply	230 V, 50 – 60 Hz	230 V, 50 – 60 Hz
Max. power consumption	1,650 W	1,650 W
Dimensions (W × D × H)	72 × 66 × 37 cm	74 × 71 × 40 cm
Footprint (dimensions w/o front panel, WxD)	72 × 62 cm	74 × 67 cm
Height (with open lid)	85 cm	94 cm
Weight w/o accessories	109 kg	139 kg
Cooling	refrigerated	refrigerated
Temperature control range	-11 °C to 40 °C	-11 °C to 40 °C
Dual use of plates and tubes in one rotor bucket	yes	yes
Fixed-angle rotors for high-speed applications	yes	yes
Plate rotor options for MTP, PCR or DWP	yes	yes
Universal adapters for conical tubes, plates and bottles	yes	yes

Centrifuge 5910 R

Description

With its great versatility, the refrigerated Centrifuge 5910 R is setting the next benchmark for benchtop centrifuges. With a comprehensive portfolio of fixed-angle and swing-bucket rotors, this centrifuge was designed to accommodate a particularly broad spectrum of applications. Cell harvests in bottles of capacities up to 1,000 mL, large-scale DNA and RNA isolations as well as Ficoll® gradients for the purification of lymphocytes and monocytes are merely a few examples of the many areas of application. The new universal swing-bucket rotor with unique universal adapters facilitates even quicker loading. This system allows centrifugation of conical vessels up to 50 mL, plates, and 250 mL bottles for the first time without the need to change rotors, rotor buckets, or adapters.



Great versatility for a variety of applications

- > Swing-bucket rotors and adapters accommodate tubes and bottles from 0.2 mL to 1,000 mL
- > Plate rotor options for centrifugation of all types of MTP, PCR or deepwell plates (DWP)
- > Fixed-angle rotors for high-speed molecular biology applications in vessels from 0.2 mL to 250 mL
- > High centrifugation speed of up to 22,132 × g (14,000 rpm)

Greater versatility

New swing-bucket standard-rotor S-4xUniversal and its unique universal adapters accommodate bottles, plates and conical tubes. No need to change rotor or rotor buckets. This improves handling and saves time.

- > Adapter 1: 5.0 mL and 15 mL conical tubes, MTP/DWP
- > Adapter 2: 25 mL and 50 mL conical tubes, MTP
- > Adapter 3: 25 mL and 50 mL conical tubes, 250 mL bottles, MTP



www.eppendorf.com/app



Centrifuge 5920 R

Description

Centrifuge 5920 R delivers extraordinary high capacity in a very compact and ergonomic product design. It has similar dimensions as competing refrigerated 3 Liter models and yet features a superior capacity of up to 4 × 1,000 mL or 52 × 50 mL thus making it the ideal instrument for high-throughput applications.



More Capacity for higher throughput

- > Swing-bucket rotors accommodate tubes and bottles from 0.2 mL to 1,000 mL
- > Fixed-angle rotors for high-speed molecular biology applications in tubes from 0.2 mL to 50 mL
- > Plate rotor options for centrifugation of all types of MTP, PCR or DWP

Rotor S-4x1000 for 1 liter bottles

- > Round buckets accommodate standard 1 liter Nalgene® bottles setting a new standard in the table top centrifuge segment
- > 4 liter capacity to process a higher volume in fewer runs
- > Range of adapters for tubes and plates available
- > Maximum rcf at 3,413 × g

New universal adapters

Unique universal adapters for rotor S-4xUniversal-Large accommodate bottles, plates and conical tubes. No need to change rotor or rotor buckets.

- > Adapter 1: 5.0 mL and 15 mL conical tubes, MTP/DWP
- > Adapter 2: 25 mL and 50 mL conical tubes, MTP
- > Adapter 3: 50 mL conical tubes, 250 mL bottles, MTP



As awarded by The Chicago Athenaeum: Museum of Architecture and Design.

Centrifuge Packages 5910 R



Ordering information

Description	Max. capacity per rotor	Order no.
Centrifuge 5910 R , refrigerated, with Rotor S-4xUniversal, 230 V/50 – 60 Hz, incl. universal buckets and adapters for 5 mL/15 mL/50 mL conical tubes and plates ¹⁾	68 x 15 mL/36 x 50 mL	5942 000 315
Centrifuge 5910 R , refrigerated, with Rotor S-4xUniversal, 230 V/50 – 60 Hz, incl. universal buckets and adapters for 5 mL/15 mL/50 mL conical tubes, 175 mL – 250 mL bottles and plates	68 x 15 mL/28 x 50 mL	5942 000 215
Centrifuge 5910 R , refrigerated, with Rotor S-4xUniversal, 230 V/50 – 60 Hz, incl. universal buckets and adapters for round-bottom tubes with diameter 13/16 mm	120 x 13 mm/104 x 16 mm	5942 000 410
Centrifuge 5910 R , refrigerated, with Rotor S-4x750, 230 V/50 – 60 Hz, incl. round buckets and adapters for 5 mL/15 mL/50 mL conical tubes	56 x 15 mL/28 x 50 mL	5942 000 515
Centrifuge 5910 R , refrigerated, with Rotor S-4x500, 230 V/50 – 60 Hz, incl. rectangular buckets and adapters for 15 mL/50 mL conical tubes	48 x 15 mL/20 x 50 mL	5942 000 615
Centrifuge 5910 R , refrigerated, with Rotor S-4x400, 230 V/50 – 60 Hz, incl. round buckets and adapters for 5 mL/15 mL/50 mL conical tubes	28 x 15 mL/16 x 50 mL	5942 000 710

¹⁾ When used with aerosol-tight caps the max. capacity is reduced to 20 x 50 mL (5 x 50 mL per bucket)

✎ Ordering information for other voltage options begins on page 450

i For more information go to www.eppendorf.com/centrifugation

Centrifuge Packages 5920 R

Ordering information

Description	Max. capacity per rotor	Order no.
Centrifuge 5920 R , refrigerated, with Rotor S-4xUniversal-Large, 230 V/50 – 60 Hz, incl. universal buckets and adapters for 15 mL/50 mL conical tubes	96 x 15 mL/40 x 50 mL	5948 000 910
Centrifuge 5920 R , refrigerated, with Rotor S-4xUniversal-Large, 230 V/50 – 60 Hz, incl. universal buckets and adapters for round-bottom tubes with diameter 13/16 mm	196 x 13 mm/148 x 16 mm	5948 000 810
Centrifuge 5920 R , refrigerated, with Rotor S-4x1000, 230 V/50 – 60 Hz, incl. high-capacity buckets and adapters for 15 mL/50 mL conical tubes	108 x 15 mL/52 x 50 mL	5948 000 210
Centrifuge 5920 R , refrigerated, with Rotor S-4x1000, 230 V/50 – 60 Hz, incl. plate/tube buckets and adapters for 15 mL/50 mL conical tubes	88 x 15 mL/40 x 50 mL	5948 000 410
Centrifuge 5920 R , refrigerated, with Rotor S-4x1000, 230 V/50 – 60 Hz, incl. round buckets and adapters for 15 mL/50 mL conical tubes	56 x 15 mL/28 x 50 mL	5948 000 315

✎ Ordering information for other voltage options begins on page 450



Swing-Bucket Rotors 59xx Family – Overview



Model	Rotor S-4xUniversal-Large	Rotor S-4x1000 high-capacity buckets	Rotor S-4x1000 plate/tube buckets	Rotor S-4x1000 round buckets
Positioning	Extra high capacity	Extra high capacity	High capacity	Medium capacity, compatible with 1 Liter bottle
5910 R				
5920 R	■	■	■	■
Universal bucket	yes	no	no	no
Aerosol-tightness	yes	no	yes	yes
Max. capacity	4 x 750 mL	8 x 250 mL	40 x 50 mL	4 x 1,000 mL
Max. RCF	4,402 x g	3,153 x g	3,076 x g	3,428 x g
Max. speed	4,250 rpm	3,700 rpm	3,700 rpm	3,700 rpm
1.5/2.0 mL micro tube	368			200
Eppendorf Tubes® 5.0 mL and 15 mL conical	96	108	88	56
50 mL conical tubes	40	52	40	28
25 mL snap cap tubes	40	48	36	24
25 mL screw cap tubes	40	52	40	28
13 mm round-bottom and blood collection tubes	196	196	140	92
16 mm round-bottom and blood collection tubes	148	144	132	80
750 mL bottles	4			4
1,000 mL Eppendorf bottles				4
1,000 mL standard bottles				4
PCR plates/MTP	20	24	40	
Deepwell plates (DWP)	8	8	8	

New
New



Eppendorf bottles for Centrifuge 5920 R									
Bottle Manufacturer	Volume	Order no.	Size Diameter x Height	Bottom shape	Material	S-4x Universal-Large	AT ¹⁾	S-4x1000 Round Bucket	AT ¹⁾
Eppendorf	400 mL	5810 729 009	80 x 133 mm	flat	PP				
Eppendorf	500 mL	5820 707 003	83 x 134 mm	flat	PP				
Eppendorf	750 mL	5820 708 000	102 x 133 mm	flat	PP	■	■	■	■
Eppendorf	400 mL	5910 707 002	81 x 117 mm	flat	PP				
Eppendorf	1,000 mL	5910 770 006	118 x 133.1 mm	flat	PP				

¹⁾ Aerosol tight cap possible.

For more information go to www.eppendorf.com/centrifugation



Model	Rotor S-4xUniversal	Rotor S-4x750 with round buckets	Rotor S-4x500	Rotor S-4x400
Positioning	High capacity and versatility	Medium capacity, high speed	Medium capacity	Medium capacity, high speed
5910 R				
5920 R	■	■	■	■
Universal bucket	yes	no	no	no
Aerosol-tightness	yes	yes	yes	yes
Max. capacity	4 x 750 mL	4 x 750 mL	4 x 500 mL	4 x 400 mL
Max. RCF	4,347 x g	4,800 x g	3,220 x g	5,263 x g
Max. speed	4,500 rpm	4,700 rpm	4,000 rpm	5,100 rpm
1.5/2.0 mL micro tube	68	200	96	104
Eppendorf Tubes® 5.0 mL and 15 mL conical	68	56	48	28
50 mL conical tubes	36	28	20	16
25 mL snap cap tubes	36	24	20	16
25 mL screw cap tubes	36	28	20	16
13 mm round-bottom and blood collection tubes	120	92	100	60
16 mm round-bottom and blood collection tubes	104	80	64	44
750 mL bottles	4	4		
1,000 mL Eppendorf bottles	4			
1,000 mL standard bottles				
PCR plates/MTP	20	16	16	
Deepwell plates (DWP)	4	4	4	

Eppendorf bottles for Centrifuge 5910 and Centrifuge 5920 R							
S-4x750	AT ¹⁾	S-4xUniversal	AT ¹⁾	S-4x500	AT ¹⁾	S-4x400	AT ¹⁾
				■			
				■	■		
■	■	■				■	■
		■	■				

Rotors for 5910 R

**Rotor S-4xUniversal**

- > High capacity swing-bucket rotor with max. speed 4,347 × g (4,500 rpm)
- > Broad range of adapters enables high versatility for tubes and flasks from 4 mL to 1,000 mL and plates
- > Universal bucket design accommodates both plates and tubes
- > Universal adapters accommodate selective plate formats and conical tubes
- > Aerosol-tight QuickLock caps for safe centrifugation of hazardous samples optionally available¹⁾²⁾³⁾
- > Buckets, caps and adapters are autoclavable

¹⁾ Aerosol-tightness tested by Public Health England, Porton Down, UK. ²⁾ Aerosol-tight caps compatible with MTP, DWP 96 500 µL, DWP 384 200 µL. Aerosol-tight caps not compatible with DWP 96 1,000 µL and 2,000 µL. ³⁾ When used with aerosol-tight caps the max. capacity is reduced to 20 × 50 mL (5 × 50 mL per adapter).

Ordering information

Description	Order no.
Rotor S-4xUniversal , incl. universal buckets	5895 200 001
Aerosol-tight caps , for Rotor S-4xUniversal, set of 2 pcs.	5910 750 005
Wide-neck bottle 750 mL , for Rotor S-4-104, S-4x750, S-4x1000, set of 2 pcs.	5820 708 000

Adapters for Rotor S-4xUniversal

Tube Volume	4 mL – 8 mL	7.5 mL – 12 mL	9 mL	12 x 75 mm, 5 mL FACS	50 mL conical, skirted	500 mL Corning®	750 mL	1,000 mL	MTP, DWP, PCR plates
Max. tube diameter	13 mm	16 mm	17.5 mm	12 mm	31 mm	96 mm	102 mm	118 mm	–
Max. vessel height	119 mm	120 mm	120 mm	112 mm	124 mm	148 mm	139 mm	133 mm	80 mm
Max. vessel height for use with cap/lid¹⁾	117 mm	118 mm	118 mm	107 mm	121 mm	–	135 mm	133 mm	66 mm
Adapter									
Number of vessels per adapter/rotor	30/120	26/104	21/84	46/184	7/28	1/4	1/4	1/4	5/20
Bottom shape	round	round	round	round	flat	conical	flat	flat	flat
Centrifugation radius	190 mm	195 mm	188 mm	189 mm	185 mm	187 mm	188 mm	188 mm	170 mm
Max. RCF	4,302 × g	4,415 × g	4,256 × g	4,279 × g	4,188 × g	4,234 × g	4,256 × g	4,256 × g	3,849 × g
Packing	set of 2 pcs.	set of 2 pcs.	set of 2 pcs.	set of 2 pcs.	set of 2 pcs.	set of 2 pcs.	set of 2 pcs.	set of 2 pcs.	set of 2 pcs.
Order no.	5910 755 007	5910 754 000	5910 762 003	5910 758 006	5910 764 006	5910 760 000	5910 757 000	5910 756 003	5910 753 004

¹⁾ Please perform a manual test to determine the actual loading capacity. ²⁾ Aerosol-tight caps compatible with MTP, DWP 96 500 µL, DWP 384 200 µL. Aerosol-tight caps not compatible with DWP 96 1,000 µL and 2,000 µL. ³⁾ Please order adapter for 25 mL conical tubes snap cap 5820 733 004. ⁴⁾ When used with aerosol-tight caps the max. capacity is reduced to 20 × 50 mL (5 × 50 mL per adapter). ⁵⁾ Please order adapter for 25 mL conical tubes screw cap 5820 734 000.

Universal Adapters for Rotor S-4xUniversal

Rotor S-4xUniversal brings outstanding versatility to those customers who need to spin a variety of vessels and plates. Three innovative universal adapters accommodate a selection of tubes, plates and bottles:

- > Adapter 1: 5.0 mL and 15 mL conical tubes, MTP/DWP
- > Adapter 2: 25 mL and 50 mL conical tubes, MTP
- > Adapter 3: 25 mL and 50 mL conical tubes, 250 mL bottles, MTP

For customers who need either stacking capability, higher speed or aerosol-tight centrifugation of certain plate formats, a separate plate carrier is available.

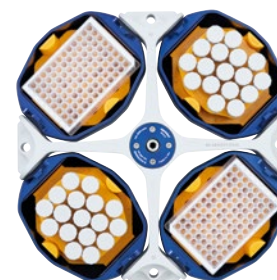

Universal adapter 1
Setup for deepwell plates and
Eppendorf Tubes® 5.0 mL.

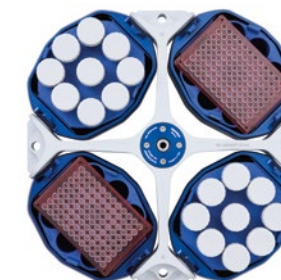

Universal adapter 2
Setup for microplates and
50 mL conical tubes.



Universal adapter 3
Setup for 50 mL conical tubes and
250 mL bottles.

17 mm	17 mm	–	39 mm	39 mm	30 mm	–	62 mm
124 mm	124 mm	64 mm	83 mm	78.5 mm	116 ⁴⁾ mm	16 mm	146 mm
122 mm	122 mm	²⁾	83 ⁴⁾ mm	78.5 ⁴⁾ mm	116 ⁴⁾ mm	–	139 mm
17/68	1/4	–	–	9/36	1/4	–	–
conical	flat	–	–	conical	flat	–	–
191 mm	143 mm	–	107 mm	156 mm	192 mm	115 mm	187 mm
4,324 × g	3,237 × g	–	3,758 × g	3,531 × g	4,347 × g	2,604 × g	4,234 × g
set of 2 pcs.	–	–	–	set of 2 pcs.	–	–	–
5910 752 008	–	–	–	5910 769 008	–	–	–
–	–	–	–	–	–	–	5910 751 001

Rotors for 5910 R



Rotor S-4x500

- > Medium capacity swing-bucket rotor with max. speed 3,220 × g (4,000 rpm)
- > Rotor S-4x500 accommodates tubes and bottles from 0.2 mL to 500 mL as well as plates
- > Aerosol-tight caps for safe centrifugation of hazardous samples optionally available¹⁾
- > Mixed loading with 2 plate buckets and 2 rectangular tube buckets allows for increased versatility
- > Buckets, caps and adapters are autoclavable

¹⁾ Aerosol-tightness tested by Public Health England, Porton Down, UK.



Ordering information

Description	Order no.
Rotor S-4x500 , for 500 mL rectangular buckets or MTP/Flex buckets	
incl. 4 x 500 mL rectangular buckets	5895 170 005
without buckets	5895 171 001
Lid , aerosol-tight, for 500 mL rectangular bucket, set of 2 pcs.	5810 724 007
MTP/Flex bucket , for Rotor A-4-81 and Rotor S-4x500, set of 2 pcs.	5810 742 005
MTP/Flex bucket , for Rotor A-4-81 and Rotor S-4x500, set of 4 pcs.	5810 741 009

Adapters for Rotor S-4x500	1.5/2.0 mL	1.2 – 5 mL	2.6 – 5 mL	2.6 – 7 mL	3 – 15 mL	7 – 17 mL
Tube Volume	1.5/2.0 mL	1.2 – 5 mL	2.6 – 5 mL	2.6 – 7 mL	3 – 15 mL	7 – 17 mL
Max. tube diameter	11 mm	11 mm	13 mm	13 mm	16 mm	17.5 mm
Max. vessel height	43 mm	108 mm	108 mm	108 mm	108 mm	118 mm
Max. vessel height for use with cap/lid¹⁾	43 mm	108 mm	107 mm	108 mm	108 mm	118 mm
Adapter						
Number of vessels per adapter/rotor	20/80	20/80	25/100	18/72	16/64	16/64
Bottom shape	flat	flat	flat with rubber mat	flat with rubber mat	flat with rubber mat	flat with rubber mat
Centrifugation radius	165 mm	168 mm	168 mm	168 mm	168 mm	168 mm
Max. RCF	2,950 × g	3,000 × g	3,000 × g	3,000 × g	3,000 × g	3,000 × g
Packing	set of 2 pcs.	set of 2 pcs.	set of 2 pcs.	set of 2 pcs.	set of 2 pcs.	set of 2 pcs.
Order no.	5810 745 004	5810 746 000	5810 720 001	5810 747 007	5810 748 003	5810 721 008

¹⁾ Please perform a manual test to determine the actual loading capacity.²⁾ Please order adapter for 50 mL conical tubes skirted 5804 737 008.

Eppendorf Tubes® 5.0 mL and 15 mL conical tubes	25 mL snap cap	25 mL screw cap	50 mL conical	30 – 50 mL and 50 mL conical tubes, skirted ²⁾	180 – 250 mL flat/ 175 – 225 mL conical	400 mL	500 mL	MTP, DWP, PCR plates
17.5 mm	39 mm	29.8 mm	30 mm	30 mm	62 mm	133 mm	83 mm	–
121 mm	83 mm	78.5 mm	122 mm	121 mm	133 mm	–	134 mm	60 mm
121 mm	83 mm	78.5 mm	116 mm	–	–	–	134 mm	–
12/48	5/20	5/20	5/20	5/20	1/4	1/4	–/4	4/16 (MTP) 1/4 (DWP)
conical	conical	conical	conical	flat with rubber mat	flat with rubber mat	flat, rubber	flat	flat with rubber mat
173 mm	158 mm	148 mm	173 mm	173 mm	173 mm	180 mm	180 mm	163 mm
3,100 × g	2,826 × g	2,647 × g	3,100 × g	3,100 × g	3,100 × g	3,220 × g	3,220 × g	2 900 × g
set of 2 pcs.	set of 2 pcs.	set of 2 pcs.	set of 2 pcs.	set of 2 pcs.	set of 2 pcs.	set of 2 pcs.	–	set of 2 pcs.
5810 722 004	5810 723 000	5810 723 000	5810 723 000	5810 739 004	5825 722 000	5810 728 002	–	5810 742 005

Rotors for 5910 R

**Rotor S-4x400**

- > High-speed medium capacity swing-bucket rotor with max. speed 5,263 × g (5,100 rpm)
- > Broad range of adapters enables high versatility for tubes and bottles from 0.2 mL to 400 mL
- > Aerosol-tight QuickLock caps for safe centrifugation of hazardous samples optionally available¹⁾
- > Buckets, caps and adapters are autoclavable

¹⁾ Aerosol-tightness tested by Public Health England, Porton Down, UK.

Ordering information

Description	Order no.
Rotor S-4x400, incl. 400 mL round bucket	5895 180 000
Aerosol-tight caps, for Rotor S-4x400, set of 2 pcs.	5910 700 008

Adapters for Rotor S-4x400						
Tube Volume	1.5 mL/2.0 mL	12 mm x 75 mm	4 mL – 8 mL	7.5 mL – 12 mL	9 mL	Eppendorf Tubes® 5.0 mL and 15 mL conical
Max. tube diameter	11 mm	12 mm	13 mm	16 mm	17.5 mm	17 mm
Max. vessel height	39 mm	118 mm	119 mm	122 mm	122 mm	133 mm
Max. vessel height for use with cap/lid¹⁾	–	112 mm	105 mm	115 mm	115 mm	126 mm
Adapter						
Number of vessels per adapter/rotor	26/104	17/68	15/60	11/44	8/32	7/28
Bottom shape	open	round	round	round	round	conical
Centrifugation radius	177 mm	172 mm	171 mm	173 mm	173 mm	180 mm
Max. RCF	5,147 × g	5,002 × g	4,818 × g	4,874 × g	4,874 × g	5,071 × g
Packing	set of 2 pcs.	set of 2 pcs.	set of 2 pcs.	set of 2 pcs.	set of 2 pcs.	set of 2 pcs.
Order no.	5910 708 009	5910 711 000	5910 703 007	5910 704 003	5910 709 005	5910 702 000

¹⁾ Please perform a manual test to determine the actual loading capacity.²⁾ Please order adapter for 25 mL conical tubes snap cap 5820 733 004.³⁾ Please order adapter for 25 mL conical tubes screw cap 5820 734 000.



25 mL snap cap ²⁾	25 mL screw cap ³⁾	50 mL conical	50 mL skirted, Centriprep and Oak Ridge 30 mL	175 mL conical (Becton Dickinson®, Nalgene®), 250 mL flat	175 – 225 mL conical	400 mL
39 mm	29.8 mm	29 mm	29 mm	62 mm	62 mm	81 mm
83 mm	78.5 mm	125 mm	122 mm	138 mm	143 mm	117 mm
83 mm	78.5 mm	117 mm	121 mm	129 mm	137 mm	117 mm
4/16	4/16	4/16	3/12	1/4	1/4	1/4
conical	conical	conical	conical	flat	conical	flat
152 mm	142 mm	179 mm	170 mm	174 mm	181 mm	173 mm
4,420 × g	4,129 × g	5,043 × g	4,943 × g	5,060 × g	5,263 × g	5,030 × g
set of 2 pcs.	set of 2 pcs.	set of 2 pcs.	set of 2 pcs.	set of 2 pcs.	set of 2 pcs.	set of 2 pcs.
5910 701 004	5910 701 004	5910 701 004	5910 712 006	5910 705 000	5910 714 009	5910 706 006

Rotors for 5910 R/5920 R

**Rotor S-4x750**

- > Medium capacity swing-bucket rotor with max. speed 4,800 × g (4,700 rpm)¹⁾
- > Broad range of adapters enables high versatility for tubes and flasks from 0.2 mL to 750 mL and plates
- > Mixed loading with 2 plate buckets and 2 round tube buckets allows for increased versatility
- > Aerosol-tight QuickLock caps for safe centrifugation of hazardous samples optionally available²⁾
- > Buckets, caps and adapters are autoclavable

¹⁾ Aerosol-tightness tested by Public Health England, Porton Down, UK.

²⁾ For 100 V device, max. speed 4,031 × g /4,300 rpm

Adapters for Rotor S-4x750							
Tube Volume	1.5/2.0 mL	12 × 75 mm, 5 mL FACS	2.6 – 8 mL	5.5 – 12 mL	9 mL	14 mL	Eppendorf Tubes® 5.0 mL and 15 mL conical
Max. tube diameter	11 mm	12 mm	13 mm	16 mm	17.5 mm	17.5 mm	17 mm
Max. vessel height	39 mm	120 mm	121 mm	125 mm	117 mm	106 mm	125 mm
Max. vessel height for use with cap/lid¹⁾	39 mm	113 mm	113 mm	120 mm	112 mm	106 mm	120 mm
Adapter							
Number of vessels per adapter/ rotor	50/200	27/108	23/92	20/80	20/80	14/56	14/56
Bottom shape	flat	round	round	round	round	round	conical
Centrifugation radius	194 mm	186 mm	185 mm	186 mm	185 mm	185 mm	188 mm
Max. RCF	4,791 × g	4,594 × g	4,569 × g	4,594 × g	4,569 × g	4,569 × g	4,643 × g
Packing	set of 2 pcs.	set of 2 pcs.	set of 2 pcs.	set of 2 pcs.	set of 2 pcs.	set of 2 pcs.	set of 2 pcs.
Order no.	5825 740 009	5825 747 003	5825 738 004	5825 736 001	5825 743 008	5825 748 000	5825 734 009

¹⁾ Exceeding the maximum tube length may reduce the loading capacity of the rotor. Please perform a manual swing-out test before starting the centrifuge run to make sure the tubes do not hit the rotor yoke.

²⁾ Please order adapter for 25 mL conical tubes snap cap 5820 733 004.³⁾ Please order adapter for 25 mL conical tubes screw cap 5820 734 000.⁴⁾ Please note that these conical bottles need to be used together with a conical form insert provided by the manufacturer. ⁵⁾ 225 mL conical bottles from BD[®]/Corning[®] and 250 mL conical bottles from Nunc[®] for Rotor S-4-104.

Ordering information

Description	Order no.
Rotor S-4x750 , aerosol-tight, without buckets	5895 121 004
Rotor S-4x750 , aerosol-tight, incl. 4 × 750 mL round buckets	5895 120 008
Plate bucket (aerosol-tight capable) , incl. plate carrier, for Rotor S-4x750, set of 2 pcs.	5895 125 000
Round bucket , for Rotor S-4x750, set of 2 pcs.	5895 123 007
Round bucket , for Rotor S-4x750, set of 4 pcs.	5895 122 000
Plate bucket (aerosol-tight capable) , incl. plate carrier, for Rotor S-4x750, set of 4 pcs.	5895 124 003
Caps for plate buckets (aerosol-tight capable) , aerosol-tight, for Rotor S-4-104 and Rotor S-4x750, set of 2 pcs.	5820 748 001
Caps for 750 mL round buckets , aerosol-tight, for Rotor S-4-104, Rotor S-4x750 and Rotor S-4x1000, set of 2 pcs.	5820 747 005
Wide-neck bottle 750 mL , for Rotor S-4-104, S-4x750, S-4x1000, set of 2 pcs.	5820 708 000

25 mL snap cap ²⁾	25 mL screw cap ³⁾	30 mL	50 mL conical	50 mL conical, skirted	250 mL flat, 175 – 225/ 250 mL conical ⁴⁾⁵⁾	500 mL Corning [®]	750 mL	MTP, DWP, PCR plates
39 mm	29.8 mm	25 mm	30 mm	30 mm	62 mm	96 mm	102 mm	–
83 mm	78.5 mm	119 mm	122 mm	122 mm	145 mm	147 mm	150 mm	64 mm
83 mm	78.5 mm	114 mm	116 mm	116 mm	125 mm	–	150 mm	47 mm
6/24	7/28	8/32	7/28	5/20	1/4	1/4	1/4	4/16 (MTP) 1/4 (DWP)
conical	conical	flat	conical	conical	flat	conical	flat	–
167 mm	157 mm	181 mm	187 mm	177 mm	183 mm	186 mm	185 mm	161 mm
4,124 × g	3,877 × g	4,470 × g	4,618 × g	4,371 × g	4,519 × g	4,594 × g	4,569 × g	3,976 × g
set of 2 pcs.	set of 2 pcs.	set of 2 pcs.	set of 2 pcs.	set of 2 pcs.	set of 2 pcs.	set of 2 pcs.	set of 2 pcs.	set of 2 pcs.
5825 733 002	5825 733 002	5825 755 006	5825 733 002	5825 732 006	5825 741 005	5825 745 000	5825 744 004	5895 125 000





Rotors for 5920 R

**Rotor S-4xUniversal-Large**



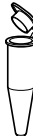

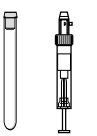
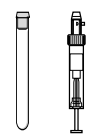
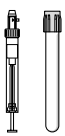

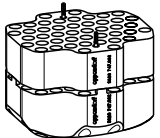
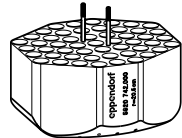
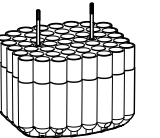
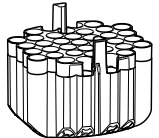
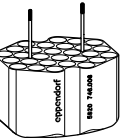
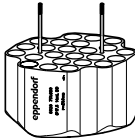
- > Extra high capacity swing-bucket rotor with max. speed 4,402 × g (4,250 rpm)
- > Broad range of adapters enables high versatility for tubes and flasks from 0.2 mL to 750 mL and plates
- > Universal bucket design accommodates both plates and tubes
- > Aerosol-tight Eppendorf QuickLock® caps for safe centrifugation of hazardous samples optionally available¹⁾
- > Buckets, caps and adapters are autoclavable

¹⁾ Aerosol-tightness tested by Public Health England, Porton Down, UK.

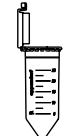

						
Adapters for Rotor S-4xUniversal-Large						
Tube Volume	1.5/2.0 mL	5 mL FACS	2.6 – 8 mL	5.5 – 12 mL	9 mL	14 mL
Max. tube diameter	11 mm	12 mm	13 mm	16 mm	17.5 mm	17.5 mm
Max. vessel height	39 mm	113 mm	110 mm	110 mm	136 mm	123 mm
Max. vessel height for use with cap/lid	39 mm	82 mm	107 mm	106 mm	130 mm	120 mm
Adapter						
Number of vessels per adapter/rotor	92/368	51/204	49/196	37/148	28/112	24/96
Bottom shape	flat	round	round	round	round	round
Centrifugation radius	205 mm	205 mm	205 mm	204 mm	209 mm	210 mm
Max. RCF	4,140 × g	4,140 × g	4,140 × g	4,120 × g	4,221 × g	4,240 × g
Packing	set of 2 pcs.	set of 2 pcs.	set of 2 pcs.	set of 2 pcs.	set of 2 pcs.	set of 2 pcs.
Order no.	5920 747 002	5920 742 000	5920 739 000	5920 738 003	5920 746 006	5920 751 000

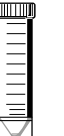
¹⁾ Please order adapter for 25 mL conical tubes snap cap 5820 733 004.²⁾ Please order adapter for 25 mL conical tubes screw cap 5820 734 000.

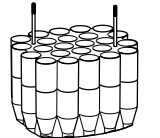
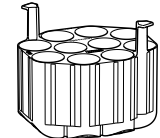
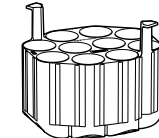
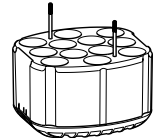
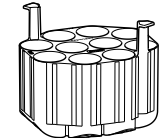
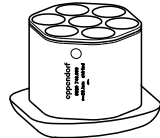
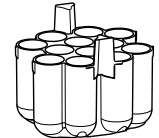

						
Eppendorf Tubes® 5.0 mL and 15 mL conical	25 mL snap cap¹⁾	25 mL screw cap²⁾	30 mL	50 mL conical	50 mL conical, skirted	50 mL Nalgene® Oak Ridge
17 mm	39 mm	29.8 mm	25 mm	30 mm	30 mm	29 mm
131 mm	83 mm	78.5 mm	117 mm	131 mm	141 mm	132 mm
123 mm	83 mm	78.5 mm	108 mm	125 mm	121 mm	121 mm
						
24/96	10/40	10/40	12/48	10/40	7/28	12/48
conical	conical	conical	flat	conical	conical	round
218 mm	189 mm	179 mm	194 mm	213 mm	197 mm	206 mm
4,402 × g	3,816 × g	3,614 × g	3,918 × g	4,301 × g	3,978 × g	4,160 × g
set of 2 pcs.	set of 2 pcs.	set of 2 pcs.	set of 2 pcs.	set of 2 pcs.	set of 2 pcs.	set of 2 pcs.
5920 736 000	5920 735 004	5920 735 004	5920 743 007	5920 735 004	5920 748 009	5920 753 002





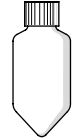

Rotors for 5920 R

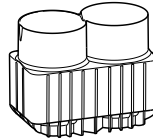
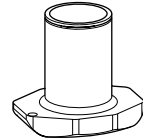
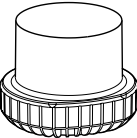

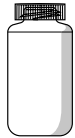
Ordering information

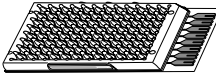
Description	Order no.
Rotor S-4xUniversal-Large, incl. buckets	5895 190 006
Aerosol-tight caps, for Rotor S-4xUniversal-Large, set of 2 pcs.	5920 752 006

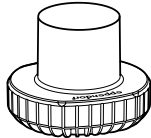
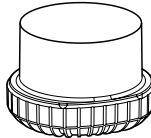
			
Adapters for Rotor S-4xUniversal-Large			
Tube Volume	250 mL flat, 175 – 225 mL conical	250 mL conical (Corning®, Nunc®)	500 mL conical Corning®
Max. tube diameter	62 mm	62 mm	96 mm
Max. vessel height	133 mm	171 mm	160 mm
Max. vessel height for use with cap/lid	126 mm	144 mm	148 mm
Adapter			
Number of vessels per adapter/rotor	2/8	1/4	1/4
Bottom shape	flat	flat	conical
Centrifugation radius	203 mm	208 mm	208 mm
Max. RCF	4,099 × g	4,200 × g	4,200 × g
Packing	set of 2 pcs.	set of 2 pcs.	set of 2 pcs.
Order no.	5920 740 008	5920 750 003	5920 744 003

			
500 mL flat Nalgene®	750 mL	Micro Fluidic Cards	MTP, DWP, PCR plates
69.5 mm	102 mm	–	–
168 mm	166 mm	153 mm	116 mm
143 mm	143 mm	–	110 mm
			
1/4	1/4	3/12	5/20 (MTP) 2/8 (DWP)
flat	flat	flat	flat
206 mm	202 mm	200 mm	196 mm
4,160 × g	4,079 × g	4,039 × g	3,938 × g
set of 2 pcs.	set of 2 pcs.	set of 2 pcs.	set of 2 pcs.
5920 745 000	5920 741 004	5920 749 005	5920 737 007

Rotors for 5920 R



Rotor S-4x1000 high-capacity buckets

- > Extra high capacity swing-bucket rotor with max. speed 3,153 x g (3,700 rpm)
- > Bucket accommodates both plates and tubes
- > Buckets, caps and adapters are autoclavable



Ordering information

Description	Order no.
Rotor S-4x1000, without buckets	5895 101 003
High-Capacity bucket, for Rotor S-4x1000, set of 4 pcs.	5895 106 005
Plate carrier for high-capacity bucket, for Rotor S-4x1000, for high-capacity buckets, set of 2 pcs.	5920 729 004

Adapters for Rotor S-4x1000 high-capacity buckets

Tube Volume	5 mL FACS	2.6 – 8 mL	5.5 – 12 mL	9 mL
Max. tube diameter	12 mm	13 mm	16 mm	17.5 mm
Max. vessel height	108 mm	107 mm	107 mm	129 mm
Adapter				
Number of vessels per adapter/rotor	52/208	49/196	36/144	29/116
Bottom shape	round	round	round	round
Centrifugation radius	204 mm	204 mm	199 mm	204 mm
Max. RCF	3,122 x g	3,122 x g	3,046 x g	3,122 x g
Packing	set of 2 pcs.	set of 2 pcs.	set of 2 pcs.	set of 2 pcs.
Order no.	5920 724 002	5920 718 002	5920 720 007	5920 722 000

¹⁾ Please order adapter for 25 mL conical tubes snap cap 5820 733 004. ²⁾ Please order adapter for 25 mL conical tubes screw cap 5820 734 000.

Eppendorf Tubes® 5.0 mL and 15 mL conical	25 mL snap cap ¹⁾	25 mL screw cap ²⁾	50 mL conical	250 mL flat, 175 – 225 mL conical and Nunc® 250 mL conical	MTP, DWP, PCR plates
17 mm	39 mm	29.8 mm	30 mm	62 mm	–
121 mm	83 mm	78.5 mm	116 mm	148 mm	88 mm
27/108	12/48	13/52	13/52	2/8	6/24 (MTP) 2/8 (DWP)
conical	conical	conical	conical	flat	flat
205 mm	179 mm	169 mm	206 mm	200 mm	185 mm
3,138 x g	2,739 x g	2,586 x g	3,153 x g	3,061 x g	2,832 x g
set of 2 pcs.	set of 2 pcs.	set of 2 pcs.	set of 2 pcs.	set of 2 pcs.	set of 2 pcs.
5920 716 000	5920 715 003	5920 715 003	5920 715 003	5920 717 006	5920 729 004

Rotors for 5920 R



Rotor S-4x1000 plate/tube buckets

- > High capacity swing-bucket rotor with max. speed 3,076 × g (3,700 rpm)
- > Bucket accommodates both plates and tubes
- > Aerosol-tight QuickLock caps for safe centrifugation of hazardous samples optionally available¹⁾
- > Buckets, caps and adapters are autoclavable

¹⁾ Aerosol-tightness tested by Public Health England, Porton Down, UK.



Ordering information

Description	Order no.
Rotor S-4x1000 , without buckets	5895 101 003
Aerosol-tight caps , for S-4x1000 plate/tube bucket and S-4x750 plate bucket, set of 2 pcs.	5895 111 009
Plate/tube bucket , for Rotor S-4x1000, set of 4 pcs.	5895 104 002
Plate carrier for plate/tube bucket , for Rotor S-4x1000 with plate/tube buckets, Rotor S-4x1000, set of 2 pcs.	5920 705 008
Plate/tube bucket , for Rotor S-4x1000, set of 2 pcs.	5895 105 009

Adapters for Rotor S-4x1000 plate/tube buckets					
Tube Volume	2.6 – 8 mL	5.5 – 12 mL	9 mL	Eppendorf Tubes® 5.0 mL and 15 mL conical	Eppendorf Tubes® 5.0 mL and 15 mL conical
Max. tube diameter	13 mm	16 mm	17.5 mm	17 mm	17 mm
Max. vessel height	109 mm	109 mm	109 mm	121 mm	123 mm
Max. vessel height for use with cap/lid¹⁾	108 mm	108 mm	109 mm	–	121 mm
Adapter					
Number of vessels per adapter/rotor	35/140	33/132	28/112	22/88	16/64
Bottom shape	round	round	round	conical	conical
Centrifugation radius	201 mm	200 mm	200 mm	201 mm	201 mm
Max. RCF	3,076 × g	3,061 × g	3,061 × g	3,076 × g	3,076 × g
Packing	set of 2 pcs.	set of 2 pcs.	set of 2 pcs.	set of 2 pcs.	set of 2 pcs.
Order no.	5920 706 004	5920 707 000	5920 708 007	5920 710 001	5920 712 004

¹⁾ Please perform a manual test to determine the actual loading capacity.²⁾ Please order adapter for 25 mL conical tubes snap cap 5820 733 004.³⁾ Please order adapter for 25 mL conical tubes screw cap 5820 734 000.

25 ml snap cap ²⁾	25 mL snap cap ²⁾	25 ml screw cap ³⁾	25 mL screw cap ³⁾	50 mL conical	50 mL conical	MTP, DWP, PCR plates
39 mm	39 mm	29,8 mm	29,8 mm	30 mm	30 mm	–
83 mm	83 mm	78,5 mm	78,5 mm	121 mm	121 mm	104 mm
–	83 mm	–	78,5 mm	–	121 mm	91 mm
9/36	6/24	10/40	7/28	10/40	7/28	10/40(MTP) 2/8(DWP)
conical	conical	conical	conical	conical	conical	flat
175 mm	107 mm	165 mm	166 mm	201 mm	201 mm	198 mm
2,678 × g	2,693 × g	2,525 × g	2,540 × g	3,076 × g	3,076 × g	3,030 × g
set of 2 pcs.	set of 2 pcs.	set of 2 pcs.	set of 2 pcs.	set of 2 pcs.	set of 2 pcs.	set of 2 pcs.
5920 709 003	5920 711 008	5920 709 003	5920 711 008	5920 709 003	5920 711 008	5920 705 008

Rotors for 5920 R



Rotor S-4x1000 round buckets

- > Medium capacity swing-bucket rotor with max. speed 3,428 x g (3,700 rpm)
- > Broad range of adapters enables high versatility for tubes and flasks from 0.2 mL to 1,000 mL and plates
- > Mixed loading with 2 plate buckets and 2 round tube buckets allows for increased versatility
- > Aerosol-tight QuickLock caps for safe centrifugation of hazardous samples optionally available¹⁾
- > Buckets, caps and adapters are autoclavable

¹⁾ Aerosol-tightness tested by Public Health England, Porton Down, UK.

Ordering information

Description	Order no.
Rotor S-4x1000 , without buckets	5895 101 003
Round bucket , for Rotor S-4x1000, set of 4 pcs.	5895 102 000
Rotor S-4x1000 round buckets , aerosol-tight, incl. 4 x 1,000 mL round buckets	5895 100 007
Aerosol-tight caps , for S-4x1000 plate/tube bucket and S-4x750 plate bucket, set of 2 pcs.	5895 111 009
Plate/tube bucket , for Rotor S-4x1000, set of 4 pcs.	5895 104 002
Plate carrier for plate/tube bucket , for Rotor S-4x1000 with plate/tube buckets, Rotor S-4x1000, set of 2 pcs.	5920 705 008
Plate/tube bucket , for Rotor S-4x1000, set of 2 pcs.	5895 105 009
Caps for 750 mL round buckets , aerosol-tight, for Rotor S-4-104, Rotor S-4x750 and Rotor S-4x1000, set of 2 pcs.	5820 747 005

Adapters for Rotor S-4x1000 round buckets								
Tube Volume	1.5/2.0 mL	12 x 75 mm, 5 mL FACS	2.6 – 8 mL	5.5 – 12 mL	9 mL	14 mL	Eppendorf Tubes® 5.0 mL and 15 mL conical	25 mL snap cap ²⁾
Max. tube diameter	11 mm	12 mm	13 mm	16 mm	17.5 mm	17.5 mm	17 mm	39 mm
Max. vessel height	39 mm	115 mm	121 mm	140 mm	117 mm	117 mm	161 mm	83 mm
Max. vessel height for use with cap/lid¹⁾	39 mm	108 mm	113 mm	140 mm	112 mm	112 mm	150 mm	83 mm
Adapter								
Number of vessels per adapter/rotor	50/200	27/108	23/92	20/80	20/80	14/56	14/56	6/24
Bottom shape	flat	round	round	round	round	round	conical	conical
Centrifugation radius	219 mm	211 mm	210 mm	211 mm	210 mm	210 mm	224 mm	107 mm
Max. RCF	3,352 x g	3,229 x g	3,214 x g	3,229 x g	3,214 x g	3,214 x g	3,428 x g	2,005 x g
Packing	set of 2 pcs.	set of 2 pcs.	set of 2 pcs.	set of 2 pcs.	set of 2 pcs.	set of 2 pcs.	set of 2 pcs.	set of 2 pcs.
Order no.	5825 740 009	5825 747 003	5825 738 004	5825 736 001	5825 743 008	5825 748 000	5825 734 009	5825 733 002

¹⁾ Exceeding the maximum tube length may reduce the loading capacity of the rotor. Please perform a manual swing-out test before starting the centrifuge run to make sure the tubes do not hit the rotor yoke.
²⁾ Please order adapter for 25 mL conical tubes snap cap 5820 733 004.
³⁾ Please order adapter for 25 mL conical tubes screw cap 5820 734 000.
⁴⁾ Please note that these conical bottles need to be used together with a conical form insert provided by the manufacturer.
⁵⁾ 225 mL conical bottles from BD®/Corning® and 250 mL conical bottles from Nunc® for Rotor S-4-104.

25 mL screw cap ³⁾	30 mL	50 mL conical	50 mL conical, skirted	250 mL flat, 175 – 225/250 mL conical ⁴⁾⁵⁾	500 mL Corning®	500 mL Nalgene®	600 mL TPP	750 mL	1 Liter Nalgene®	MTP, DWP, PCR plates
29.8 mm	25 mm	30 mm	30 mm	62 mm	96 mm	69.5 mm	98 mm	102 mm	98 mm	–
78.5 mm	144 mm	156 mm	151 mm	176 mm	167 mm	183 mm	181 mm	150 mm	196 mm	104 mm
78.5 mm	139 mm	150 mm	147 mm	156 mm	167 mm	183 mm	181 mm	150 mm	–	91 mm
7/28	8/32	7/28	5/20	1/4	1/4	1/4	1/4	1/4	1/4	7/28 (MTP) 2/8 (DWP)
conical	flat	conical	conical	flat	conical	flat	conical	flat	flat	flat
121 mm	212 mm	223 mm	209 mm	214 mm	218 mm	221 mm	224 mm	216 mm	218 mm	198 mm
1,852 x g	3,245 x g	3,413 x g	3,199 x g	3,275 x g	3,336 x g	3,382 x g	3,428 x g	3,306 x g	3,336 x g	3,030 x g
set of 2 pcs.	set of 2 pcs.	set of 2 pcs.	set of 2 pcs.	set of 2 pcs.	set of 2 pcs.	set of 2 pcs.	set of 2 pcs.	set of 2 pcs.	set of 2 pcs.	set of 2 pcs.
5825 733 002	5825 755 006	5825 733 002	5825 732 006	5825 741 005	5825 745 000	5920 703 005	5920 701 002	5825 744 004	5920 700 006	5895 105 009

Fixed-Angle Rotors 59xx Family - Overview



New

Model	Rotor FA-6x250	Rotor FA-6x50	Rotor FA-20x5
Positioning	Processing of cells in higher volumes at high speed	Molecular biology applications in tubes up to 50 mL	Applications in Eppendorf Tubes® 5.0 mL
5910 R	■	■	■
5920 R	■	■	■
Aerosol-tightness	yes	yes	yes
Max. capacity	6 × 250 mL	6 × 50 mL	20 × 5 mL
Max. RCF	15,054 × g	20,130 × g	20,913 × g
Max. speed	10,100 rpm	12,100 rpm	13,100 rpm
1.5/2.0 mL micro tube		6	20
Eppendorf Tubes® 5.0 mL and 15 mL conical	24	6	20/0
25 mL conical tubes	6 ¹⁾²⁾	6 ²⁾³⁾	
50 mL conical tubes	6	6	
85 mL Oakridge®	6		
250 mL conical tubes	6		

¹⁾ Screw cap tubes only. ²⁾ Please order adapter for 25 mL conical tubes screw cap 5820 734 000. ³⁾ Please order adapter for 25 mL conical tubes snap cap 5820 733 004.

New



Model	Rotor FA-48x2	Rotor FA-30x2	Rotor F-48x15
Positioning	Aerosol-tight microcentrifuge tube rotor	Aerosol-tight microcentrifuge tube rotor for safe centrifugation of hazardous samples	High-capacity fixed-angle rotor for 15 mL conical and glass tubes
5910 R	■	■	■
5920 R	■	-	-
Aerosol-tightness	yes	yes	
Max. capacity	48 × 2 mL	30 × 2 mL	40 × 15 mL
Max. RCF	21,194 × g (5920 R) / 22,132 × g (5910 R)	20,984 × g	5,005 × g
Max. speed	13,700 rpm (5920 R) / 14,000 rpm (5910 R)	13,700 rpm	5,500 rpm
1.5/2.0 mL micro tube	48	30	
Eppendorf Tubes® 5.0 mL and 15 mL conical			0/40

Advanced Rotor Design – Fixed-Angle Rotors



Cross section of Rotor FA-6x50 (6 × 50 mL conical) showing the light-weight design.

All metal not needed for safety or performance is hollowed out to reduce weight and improve handling.

Low rotor weight

Eppendorf's fixed-angle rotors are among the lightest in the industry to improve handling and operational safety. Light-weight rotors cause less wear and tear on the motor and allow for faster acceleration and braking times.

Eppendorf QuickLock® lids for ergonomic lid locking

Our aerosol-tight QuickLock rotors close with only ¼ of a turn. This not only saves you time during every day use, it also takes repetitive stress off your wrist.

Superior temperature control

Aluminum, with its high heat conductivity, allows fast pre-cooling and accurate temperature control in refrigerated centrifuges.



Perfect fit with Eppendorf Conical Tubes 15 mL and 50 mL

The Eppendorf Conical Tubes are characterized by an outstanding centrifugation stability of up to 19,500 × g¹⁾. This makes them suited for a broad range of applications.

¹⁾ Test conditions: Rotor FA-45-6-30 in Eppendorf Centrifuge 5810 R (using a suitable centrifuge adapter for 15 mL tube), sample: Saline solution (density: 1.0 g/mL), controlled centrifugation temp.: 25 °C, centrifugation time: 90 min

For more information go to www.eppendorf.com/centrifugation

Rotors for 5910 R/5920 R



New

Rotor FA-6x250

- > Fixed-angle rotor for up to 6 x 250 mL bottles¹⁾
- > Ideal for the pelleting of microorganisms and mammalian cells
- > 12 different adapters for broad range of additional applications
- > Max. speed 15,054 x g (10,100 rpm)
- > Eppendorf QuickLock® rotor lid for fast lid locking
- > Aerosol-tight²⁾ for safe centrifugation of hazardous samples
- > Low weight of only 5,450 g for stress-free work
- > Anodized aluminum for high chemical resistance
- > Rotor, lid and adapters are autoclavable to reduce risk of contamination
- > See tab 'Additional information' for overview of adapters available

¹⁾ To run this rotor, a software update is required for earlier centrifuges. Please contact your local Eppendorf organization or dealer for further information. ²⁾ Aerosol-tightness tested by Public Health England, Porton Down, UK. Maximum 80 % of maximum filling volume.

Ordering information

Description	Order no.
Rotor FA-6x250 , for 6 x 250 mL bottles	
incl. aerosol-tight Eppendorf QuickLock® rotor lid	5895 175 007

Adapters for Rotor FA-6x250	5 mL	2.6 – 8.0 mL	5.5 – 12.0 mL	9 mL	Eppendorf Tubes® 5.0 mL ²⁾ and 15 mL	25 mL screw cap ³⁾	50 mL
Max. tube diameter	12 mm	13 mm	16 mm	17.5 mm	17 mm	29.8 mm	30 mm
Max. vessel height for use with cap/lid¹⁾	114 mm	114 mm	115 mm	112 mm	122 mm	78.5 mm	125 mm
Adapter							
Number of vessels per adapter/rotor	9/54	8/48	7/42	7/42	4/24	1/6	1/6
Bottom shape	round	round	round	round	conical	conical	conical
Centrifugation radius	126 mm	125 mm	125 mm	126 mm	120 mm	95 mm	110 mm
Max. RCF	14,370 x g	14,256 x g	14,256 x g	14,370 x g	13,686 x g	10,834 x g	12,545 x g
Packing	set of 2 pcs.	set of 2 pcs.	set of 2 pcs.	set of 2 pcs.	set of 2 pcs.	set of 2 pcs.	set of 2 pcs.
Order no.	5920 765 000	5920 763 008	5920 762 001	5920 764 004	5920 761 005	5920 760 009	5920 760 009

¹⁾ Please perform a manual test to determine the actual loading capacity. ²⁾ Universal adapters for Eppendorf Tubes® 5.0 mL are required in addition (order no. 5820 732 008). ³⁾ Please order adapter for 25 mL conical tubes screw cap 5820 734 000. ⁴⁾ 175 mL conical bottles from BD/Corning® (352076). Please note that these conical bottles need to be used together with a conical form insert provided by the bottle manufacturer. ⁵⁾ 250 mL flat bottom bottles from Nalgene® (3127-0250, 3122-0250, 3120-0250) and Corning® (431841, 431842). When used with wide lid 250 mL flat bottom bottle from Nalgene® (3140-0250) max. capacity is reduced to 4 x 250 mL.



50 mL	10 mL	16 mL	30 mL	50 mL	85 mL	175 mL ⁴⁾	250 mL ⁵⁾
30 mm	17 mm	18 mm	26 mm	29 mm	38 mm	62 mm	62 mm
125 mm	115 mm	115 mm	116 mm	125 mm	118 mm	118 mm	135 mm
1/6	7/42	7/42	3/18	1/6	1/6	1/6	1/6
conical, skirted	round	round	round	round	round	conical	flat
108 mm	126 mm	126 mm	125 mm	111 mm	113 mm	132 mm	132 mm
12,317 x g	14,370 x g	14,370 x g	14,256 x g	12,659 x g	12,887 x g	15,054 x g	15,054 x g
set of 2 pcs.	set of 2 pcs.	set of 2 pcs.	set of 2 pcs.	set of 2 pcs.	set of 2 pcs.	–	–
5920 766 007	5920 769 006	5920 770 004	5920 767 003	5920 771 000	5920 768 000	Conical form insert required ⁴⁾	No adapter required ⁵⁾

Rotors for 5910 R/5920 R

**Rotor FA-6x50**

- > High-speed rotor for applications in tubes from 5 – 50 mL
- > Max. speed 20,133 × g (12,100 rpm)
- > Eppendorf QuickLock® rotor lid for fast lid locking
- > Aerosol-tight¹⁾ for safe centrifugation of hazardous samples
- > Low rotor weight (3.2 kg) for easy handling
- > Anodized aluminum for high chemical resistance
- > 45° borehole angle minimizes pellets smear
- > Rotor, lid and adapters are autoclavable

¹⁾ Aerosol-tightness tested by Public Health England, Porton Down, UK.

Ordering information

Description	Order no.
Rotor FA-6x50, aerosol-tight, incl. rotor lid	5895 150 004

Adapters for Rotor FA-6x50

Tube Volume	2.6 – 5 mL	4 – 8 mL	5.5 – 10 mL	7.5 – 12 mL	Eppendorf Tubes® 5.0 mL	7 – 17 mL
Max. tube diameter	13 mm	13 mm	16 mm	16 mm	17 mm	17.5 mm
Max. vessel height for use with cap/lid	119 mm	119 mm	119 mm	119 mm	121 mm	112 mm
Adapter						
Number of vessels per adapter/rotor	1/6	1/6	1/6	1/6	1/6 ¹⁾	1/6
Bottom shape	round	round	round	round	conical	round
Centrifugation radius	120 mm	120 mm	120 mm	120 mm	121 mm	120 mm
Max. RCF	19,642 × g	19,642 × g	19,642 × g	19,642 × g	19,806 × g	19,642 × g
Packing	set of 2 pcs.	set of 2 pcs.	set of 2 pcs.	set of 2 pcs.	set of 2 pcs.	set of 2 pcs.
Order no.	5820 726 008	5820 725 001	5820 728 000	5820 727 004	5820 730 005	5820 729 007

¹⁾ Eppendorf Tubes® 5.0 mL with screw cap will not fit in this adapter.

Eppendorf Conical Tubes

Whether centrifugation, mixing, or other applications – the Eppendorf Conical Tubes 15 mL, 25 mL and 50 mL will perfectly fit into your workflows. They represent the next step in Eppendorf's comprehensive system solutions in liquid, sample and cell handling.

More information: www.eppendorf.com/conicals



15 mL	15 – 18 mL	20 – 30 mL	25 mL snap cap	25 mL screw cap	35 mL	50 mL conical
17 mm	18 mm	26 mm	39 mm	29.8	29 mm	30 mm
125 mm	107 mm	104 mm	83 mm	78.5 mm	113 mm	127 mm
1/6	1/6	1/6	1/6	1/6	1/6	-/6
conical	round	round	conical	conical	conical	conical
120 mm	120 mm	105 mm	104 mm	97 mm	112 mm	123 mm
19,642 × g	19,642 × g	17,187 × g	17,023 × g	15,877 × g	18,333 × g	20,133 × g
set of 2 pcs.	set of 2 pcs.	set of 2 pcs.	set of 6 pcs.	set of 6 pcs.	set of 2 pcs.	-
5820 717 009	5820 720 000	5820 721 006	5820 733 004	5820 734 000	5820 722 002	-

Rotors for 5910 R/5920 R

**Rotor FA-20x5**

- > 20 places for Eppendorf Tubes® 5.0 mL¹⁾
- > Max. speed: 20,913 × g (13,100 rpm)
- > Aerosol-tight²⁾ Eppendorf QuickLock® rotor lid
- > Rotor, lid and adapters are autoclavable (121 °C, 20 min)
- > Anodized aluminum for high chemical resistance

¹⁾ For Eppendorf Tubes® 5.0 mL with screw cap the capacity is limited to 10 tubes. ²⁾ Aerosol-tightness tested by Public Health England, Porton Down, UK.

Ordering information

Description	Order no.
Rotor FA-20x5 , for 20 Eppendorf Tubes® 5.0 mL, incl. aerosol-tight Eppendorf QuickLock® rotor lid	5895 130 003
Adapter , for 1 PCR tube 0.2 mL, max. Ø 6 mm, for all 1.5/2.0 mL rotors, set of 6 pcs.	5425 715 005
Adapter , for 1 tube 0.5 mL or BD Microtainer®, max. Ø 8 mm, for all 1.5/2.0 mL rotors, set of 6 pcs.	5425 716 001
Adapter , for 1 vessel 1.5 – 2.0 mL, for all 5.0 mL rotors, set of 4 pcs.	5820 768 002
Adapter , for 1 cryo tube, for all 5.0 mL rotors, set of 4 pcs.	5820 769 009
Adapter , for 1 HPLC tube, for all 5.0 mL rotors, set of 4 pcs.	5820 770 007
Adapter , for 1 tube 0.4 mL, max. Ø 6 mm, for all 1.5/2.0 mL rotors, set of 6 pcs.	5425 717 008

**Rotor FA-48x2**

- > 48 places for 1.5/2.0 mL tubes
- > Max. speed: 21,194 × g/13,700 rpm (5920 R)/ 22,132 × g/ 14,000 rpm (5910 R)
- > Eppendorf QuickLock® rotor lid for fast lid locking
- > Aerosol-tight¹⁾ for safe centrifugation of hazardous samples
- > Anodized aluminum for high chemical resistance
- > Rotor and lid are autoclavable (121 °C, 20 min)

¹⁾ Aerosol-tightness tested by Public Health England, Porton Down, UK.

Ordering information

Description	Order no.
Rotor FA-48x2 , incl. aerosol-tight Eppendorf QuickLock® rotor lid	5895 135 005

Rotors for 5910 R

**Rotor F-48x15**

- > High-capacity fixed-angle rotor for 15 mL conical and glass tubes
- > Maximum speed: 5,005 × g (5,500 rpm)
- > Form inserts for 15 mL conical tubes

Ordering information

Description	Order no.
Rotor F-48x15 , for 40 x 15 mL conical tubes, incl. 48 steel sleeves and adapters	5895 160 000

**Rotor FA-30x2**

- > 30 places for 1.5/2.0 mL tubes
- > Max. speed: 20,984 × g (max. 13,700 rpm)
- > Eppendorf QuickLock® rotor lid for fast lid locking
- > Aerosol-tight for safe centrifugation of hazardous samples¹⁾
- > Anodized aluminum for high chemical resistance
- > Rotor and lid are autoclavable (121 °C, 20 min)

¹⁾ Aerosol-tightness tested by Public Health England, Porton Down, UK.

Ordering information

Description	Order no.
Rotor FA-30x2 , incl. aerosol-tight Eppendorf QuickLock® rotor lid	5895 155 006

Concentrator plus

Description

The Concentrator plus with its new design was designed with the customer in mind to deliver an ergonomic, intuitive and durable solution that fits comfortably right on the lab bench. An advanced heating technology provides best treatment for your sample which assures quick, efficient and gentle vacuum concentration of DNA/RNA, nucleotides, proteins and other liquid or wet samples. Our new coated lid provides superior chemical resistance against aggressive acids and organic solvents (e.g. TFA, DMSO).

The Concentrator plus is available with three configurations to meet the customers' lab specific needs:

- 1) Basic Concentrator for connecting to an existing vacuum pump
- 2) Complete system with an integrated solvent-resistant, maintenance and oil-free PTFE pump, and condensation trap
- 3) Complete system with vacuum port adds extra capability. It allows for using the integrated vacuum pump separately – without having to disconnect it from the system

Product features

- > Comes in 3 system configurations
- > Extremely quiet operation <50 dB(A)
- > Chemical-resistant, maintenance-free PTFE diaphragm pump eliminates the need for changing pump oil
- > Small footprint saves valuable bench space
- > Wide variety of 15 different rotor options to accommodate tubes from 0.2 mL to 50 mL, microplates and PCR plates
- > Motorless induction drive and chemical-resistant, stainless steel chamber for trouble-free operation
- > Can be connected with most commercially available cold traps for use with vapors
- > Coated lid with superior chemical resistance



Technical specifications	Concentrator plus basic	Concentrator plus system	Concentrator plus system w/port
Model			
Vacuum	–	20 hPa (20 mbar)	20 hPa (20 mbar)
Sample capacity	max. 144 vessels/2 microplates	max. 144 vessels/2 microplates	max. 144 vessels/2 microplates
Fixed speed	1,400 rpm	1,400 rpm	1,400 rpm
Tube volume	0.2 – 50 mL	0.2 – 50 mL	0.2 – 50 mL
Port to connect external devices to vacuum pump	no	no	yes
Max. power consumption	150 W	350 W	350 W
Dimensions (W x D x H)	33 x 37 x 23 cm	33 x 58 x 29 cm	33 x 58 x 29 cm
Weight w/o accessories	16.5 kg	31.5 kg	31.5 kg

For more information go to www.eppendorf.com/centrifugation



Concentrator junction system

The complete "junction" system adds extra capability/flexibility. It allows you to use the integrated vacuum pump separately – without having to disconnect it from the system; simply connect the port to any external device that requires vacuum (e.g. gel dryer).



Key function

- > Timer selection between 1 min and 9:59 as well as Brake function
- > Temperature preselection: room temperature, 30 °C, 45 °C and 60 °C
- > Mode/vent function: choose between three solvent modes
- > Start/Stop of concentration process





Ordering information

Description	Order no.
Concentrator plus basic device	
230 V/50 – 60 Hz, with Rotor F-45-48-11	5305 000 100
Concentrator plus complete system	
230 V/50 – 60 Hz, with integrated diaphragm vacuum pump, with Rotor F-45-48-11	5305 000 304
230 V/50 – 60 Hz, with integrated diaphragm vacuum pump, without rotor	5305 000 509
230 V/50 – 60 Hz, with integrated diaphragm vacuum pump; with connection, e.g., for a gel dryer; without rotor	5305 000 703
Adapter , for 1 PCR tube 0.2 mL, max. Ø 6 mm, for all 1.5/2.0 mL rotors, set of 6 pcs.	5425 715 005
Adapter , for 1 tube 0.5 mL or BD Microtainer®, max. Ø 8 mm, for all 1.5/2.0 mL rotors, set of 6 pcs.	5425 716 001
CombiSlide Adapter , for 12 slides Combi Slide, for Rotors A-2-MTP and A-4-81 (MTP), set of 2 pcs.	5825 706 005
Adapter , for 1 PCR tube 0.2 mL, for Rotor F-45-72-8, set of 6 pcs.	5425 723 008
Rotor spacer , required for stacking rotors F-45-72-8 and F-45-48-11	5301 316 005
Work tray , for semi-/unskirted PCR plates, PCR strips and 0.2 mL PCR tubes, for Rotor A-2-VC, set of 10 pcs.	0030 124 235
Frame for work tray , for Rotor A-2-VC, set of 5 pcs.	0030 124 243

Ordering information for other voltage options begins on page 450

Rotors for Concentrator plus

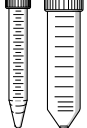
Ordering information

	Description	Max. tube dimensions Ø x L	Sample capacity	Order no.
	Rotor F-45-72-8	8 x 31 mm ¹⁾	72 x 0.5 mL	5490 034 007
	Rotor F-45-70-11	11 x 41/47 mm	70 x 1.5 mL, 70 x 2.0 mL	5490 032 004
	Rotor F-45-48-11	11 x 41/47 mm ¹⁾	48 x 1.5 mL / 2.0 mL	5490 030 001
	Rotor F-40-36-12	12 x 32 mm	36 x 1.5 mL	5490 040 007
	Rotor F-45-36-15	15 x 45 - 48 mm ²⁾	36 x 3.0/5.0 mL	5490 035 003
	Rotor F-45-16-20	20 x 42 - 55 mm ²⁾	16 x 6.5/10 mL	5490 043 006
	Rotor F-40-18-19	19 x 66 mm	18 x 10 mL	5490 037 006
	Rotor F-45-12-31	31 x 55 mm	12 x 20 mL	5490 044 002
	Rotor F-35-8-24	24 x 86 - 105 mm ²⁾	8 x 25 mL	5490 039 009
	Rotor F-45-24-12	12 x 67 - 100 mm ^{2) 3)}	24 x 5 - 7 mL	5490 036 000
	Rotor F-50-8-16	16 x 105 - 120 mm ²⁾	8 x 8 - 12 mL	5490 041 003
	Rotor F-50-8-18	18 x 105 - 128 mm ²⁾	8 x 10 - 18 mL	5490 042 000
	Rotor F-45-8-17	17 x 116 - 123 mm ²⁾	8 x 15 mL conical tubes	5490 038 002
	Rotor F-35-6-30	17 x 116 - 123 mm or 30 x 116 - 123 mm ²⁾	6 x 15 mL conical tubes or 6 x 50 mL conical tubes	5490 047 001
	Rotor A-2-VC	128 x 86 x 27 mm	2 x MTP or skirted PCR plates 2 x Deepwell plates (DWP) (max. height = 27 mm)	5490 045 009

¹⁾ Rotor is stackable for double capacity using spacer 5301 316.005. ²⁾ Min./max. tube length. ³⁾ Tube length = 75 mm: max capacity 24 tubes, tube length > 75 mm: max capacity 12 tubes.



Rotor F-35-6-30

- > Rotor for 6 x 50 mL conical tubes
- > Rotor for 6 x 15 mL conical tubes
- > Also accommodates for 6 x 25 mL conical tubes



Rotor A-2-VC

- > For use with MTP, PCR and Deepwell Plates up to 27 mm high
- > A work tray with frame is available for PCR test plates and microplates without frames
- > Rotor can be autoclaved for 20 min. at 121 °C
- > Suitable for the CombiSlide Adapter



Rotor F-45-48-11

- > Rotor for 48 x 1.5/2.0 mL microcentrifuge tubes
- > A spacer enables additional stacking (double capacity)

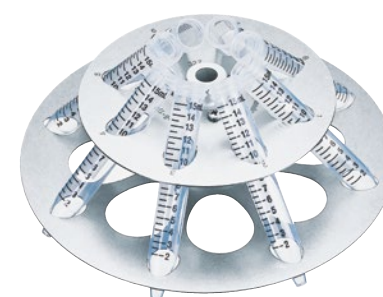

Rotor F-45-8-17

- > Rotor for 8 x 15 mL conical tubes



Sample Handling



Model	Eppendorf BioSpectrometer® fluorescence	Eppendorf BioSpectrometer® kinetic
Page(s)	237	236
Wavelength range absorption	Scan (nm): 200 – 830 at 1 nm increments	Scan (nm): 200 – 830 at 1 nm increments
Wavelength Selection Increment	1 nm	1 nm
Scanning	yes	yes
Spectral bandwidth	≤4 nm	≤4 nm
Systematic error wavelength	±1 nm	±1 nm
Random error wavelength	≤0.5 nm	≤0.5 nm
Absorption measuring range	0 A – 3.0 A (260 nm)	0 A – 3.0 A (260 nm)
Systematic error absorption	–	±1 % (A = 1)
Random error absorption	≤0.002 at A = 0 ≤0.005 (0.5 %) at A = 1	≤0.002 at A = 0 ≤0.005 (0.5 %) at A = 1
Light source absorption	Xenon flash lamp	Xenon flash lamp
Detector Type	CMOS photodiode array, 1024 pixel	CMOS photodiode array, 1024 pixel
Measuring principle absorption	Single-beam absorption spectrophotometer with reference beam	Single-beam absorption spectrophotometer with reference beam
Sample light path length	8.5 mm	8.5 mm
Light source fluorescence	LED	–
Beam receiver fluorescence	Photodiodes	–
Measuring principle fluorescence	Confocal filter fluorometer with reference beam	–
Fluorescence measuring range	0.5 nM – 2,000 nM fluorescein (emission wavelength 520 nm)	–
dsDNA concentration range (for 1 to 10 mm path length)	2.5 ng/μL – 45,450 ng/μL (with fluorescence down to 1 pg/μL)	2.5 ng/μL – 1,500 ng/μL
BSA concentration range (for 1 to 10 mm path length, calculation factor for BSA = 1.515 μg/μL)	76 ng/μL – 45,450 ng/μL (with fluorescence down to 0.01 ng/μL)	76 ng/μL – 45,450 ng/μL
Operator guidance language	Spanish, Italian, French, English, German, Japanese	Spanish, Italian, French, English, German, Japanese
Method memory	>100 method programs	>100 method programs
Dimensions (W x D x H)	295 x 400 x 150 mm / 11.6 x 15.7 x 6 in	295 x 400 x 150 mm / 11.6 x 15.7 x 6 in
Weight w/o accessories	5.4 kg	5.5 kg
Cuvette shaft	12.5 mm x 12.5 mm	12.5 mm x 12.5 mm, tempered 20 °C – 42 °C
Power supply	100 – 240 V, 50 – 60 Hz	100 – 240 V, 50 – 60 Hz
Power consumption	Approx. 15 W during operating step Approx. 5 W with dimmed display	Approx. 30 W during operating step Approx. 5 W with dimmed display and temperature control switched off
Interfaces	<ul style="list-style-type: none"> > USB master: for USB stick and thermal printer DPU-S445 > USB slave for connecting to a PC (All functions available without PC) > Serial interface RS-232: for thermal printer DPU-414 > Ethernet interface RJ45: For connecting to a network printer or emailing data outputs directly off instrument 	<ul style="list-style-type: none"> > USB master: for USB stick and thermal printer DPU-S445 > USB slave for connecting to a PC (All functions available without PC) > Serial interface RS-232: for thermal printer DPU-414 > Ethernet interface RJ45: For connecting to a network printer or emailing data outputs directly off instrument

Model	Eppendorf BioSpectrometer® basic	Eppendorf BioPhotometer® D30
Page(s)	235	234
Wavelength range absorption	Scan (nm): 200 – 830 at 1 nm increments	230, 260, 280, 320, 340, 405, 490, 562, 595, 600 nm
Wavelength Selection Increment	1 nm	N/A
Scanning	yes	no
Spectral bandwidth	≤4 nm	≤4 nm
Systematic error wavelength	±1 nm	±1 nm
Random error wavelength	≤0.5 nm	≤0.5 nm
Absorption measuring range	0 A – 3.0 A (260 nm)	0 A – 3.0 A (260 nm)
Systematic error absorption	±1 % (A = 1)	±1 % (A = 1)
Random error absorption	≤0.002 at A = 0 ≤0.005 (0.5 %) at A = 1	≤0.002 at A = 0 ≤0.005 (0.5 %) at A = 1
Light source absorption	Xenon flash lamp	Xenon flash lamp
Detector Type	CMOS photodiode array, 1024 pixel	CMOS photodiodes
Measuring principle absorption	Single-beam absorption spectrophotometer with reference beam	Single-beam absorption photometer with reference beam
Sample light path length	8.5 mm	8.5 mm
Light source fluorescence	–	–
Beam receiver fluorescence	–	N/A
Measuring principle fluorescence	–	–
Fluorescence measuring range	–	–
dsDNA concentration range (for 1 to 10 mm path length)	2.5 ng/μL – 1,500 ng/μL	2.5 ng/μL – 1,500 ng/μL
BSA concentration range (for 1 to 10 mm path length, calculation factor for BSA = 1.515 μg/μL)	76 ng/μL – 45,450 ng/μL	76 ng/μL – 45,450 ng/μL
Operator guidance language	Spanish, Italian, French, English, German, Japanese	Spanish, Italian, French, English, German, Japanese
Method memory	>100 method programs	>100 method programs
Dimensions (W x D x H)	295 x 400 x 150 mm / 11.6 x 15.7 x 6 in	295 x 400 x 150 mm / 11.6 x 15.7 x 6 in
Weight w/o accessories	5.4 kg	5.4 kg
Cuvette shaft	12.5 mm x 12.5 mm	12.5 mm x 12.5 mm
Power supply	100 – 240 V, 50 – 60 Hz	100 – 240 V, 50 – 60 Hz
Power consumption	Approx. 15 W during operating step Approx. 5 W with dimmed display	Approx. 15 W during operating step Approx. 5 W with dimmed display
Interfaces	<ul style="list-style-type: none"> > USB master: for USB stick and thermal printer DPU-S445 > USB slave for connecting to a PC (All functions available without PC) > Serial interface RS-232: for thermal printer DPU-414 > Ethernet interface RJ45: For connecting to a network printer or emailing data outputs directly off instrument 	<ul style="list-style-type: none"> > USB master: for USB stick and thermal printer DPU-S445 > USB slave for connecting to a PC (All functions available without PC) > Serial interface RS-232: for thermal printer DPU-414 > Ethernet interface RJ45: For connecting to a network printer or emailing data outputs directly off instrument



Eppendorf BioPhotometer® D30

Description

The Eppendorf BioPhotometer D30 is the 3rd generation of Eppendorf spectrophotometers to become an established standard in the life sciences. Routine pre-defined wavelengths are easily selectable, allowing for quick and simple programming. Users are guided through every step of the assay with short, simple on-screen instructions. The ultra-stable Xenon flash lamp doesn't require any warm up time and a measurement typically takes 5 seconds. Raw and processed data are clearly presented on the large color screen and can be exported directly from the instrument in a variety of common formats. Eppendorf disposable UVette® cuvettes enable measurements with as little as 50 µL of sample and the Eppendorf µCuvette® G1.0 reduces this further to 1.5 µL of sample.

Product features

- > Absorption measurements for one or more fixed wavelengths
- > Scan for specific UV applications with automatically determined purity ratios
- > Preprogrammed applications for quick start and applications with evaluation via factor, standard or standard series
- > Integrated application and results memory
- > Guided software process to minimize errors
- > Compatible with standard, semi-micro and micro-volume measuring cells
- > Fixed wavelengths without moving parts for a long life time
- > Integrated self-test and calibration history for documentation
- > Data transfer via USB interface, Ethernet or via e-mail and direct printout of results
- > Data output as *.PNG screenshots, Microsoft® Excel®, or secure PDF files to a standard USB flash drive or via email



Applications

- > Nucleic acid quantification
- > Direct protein quantification (UV 280 nm)
- > Microvolume measurement via µCuvette G1.0 for highly concentrated samples
- > Bacteria growth measurement (OD 600)
- > Colorimetric assays for protein quantification, e.g., BCA, Bradford, Lowry
- > 340 nm: endpoint assays using NADPH or NAPH
- > 405 nm: endpoint assays using para-nitrophenol
- > 490 nm: cytotoxicity endpoint assay
- > Transmission measurement



www.eppendorf.com/D30-Poster

Ordering information

Description	Order no.
Eppendorf BioPhotometer® D30, 230 V/50 – 60 Hz	6133 000 001
Eppendorf µCuvette® G1.0 and Eppendorf BioPhotometer® D30, 230 V/50 – 60 Hz	6133 000 907
Eppendorf BioPhotometer® D30 Reference Filter Set, filter set for verifying photometric accuracy and wavelength systematic error (according to NIST®)	6133 928 004
Thermal Printer DPU-S445	6135 011 000

✂ Ordering information for other voltage options begins on page 450

i For more information go to www.eppendorf.com/photometry

Eppendorf BioSpectrometer® basic

Description

Building on the legacy of the Eppendorf BioPhotometer D30, the Eppendorf BioSpectrometer basic shares its simplicity, flexibility and reliability. In addition to the Biophotometer D30, the Biospectrometer basic has freely selectable wavelengths from 200 – 830 nm (selectable in 1 nm increments). This allows the user to define the parameters of each assay, whether it be a scan, a single-wavelength measurement or a multi-wavelength measurement. The Eppendorf BioSpectrometer basic caters to more disciplines as the wavelengths are not pre-defined and allows for non-routine assays or new assays to be easily programmed (in addition to the pre-programmed routine methods). The Eppendorf BioSpectrometer basic is a robust yet flexible "workhorse".

Product features

- > Absorbance measurement for one or more wavelengths, recording of wavelength scans from 200 nm to 830 nm (increment: 1 nm)
- > Automatic evaluation and storage of measurement data with clear presentation of results
- > Spectral graph to display sample purity with automatic ratio calculation
- > Freely programmable applications with evaluation via factor, standard or standard series and freely programmable parameters
- > Two-wavelength method with subtraction or division evaluation
- > Integrated application and results memory
- > Guided software process to minimize errors
- > Integrated self-test and calibration history
- > Data transfer via USB interface, Ethernet or via e-mail and direct printout of results
- > Data output as *.PNG screenshots, Microsoft® Excel®, or secure PDF files to a standard USB flash drive or via email



Applications

- > Nucleic acid quantification
- > Direct protein quantification (UV 280 nm)
- > Microvolume measurement via µCuvette G1.0 for highly concentrated samples
- > Bacteria growth measurement (OD 600)
- > Colorimetric assays for protein quantification, e.g., BCA, Bradford, Lowry
- > Evaluation of FOI for dye-labeled biomolecules (nucleic acid or proteins)
- > Free selectable wavelengths, e.g., 340 nm: assays using NADPH or NAPH, 405 nm: assays using para-nitrophenol, 420 nm: assays using ortho-nitrophenol, 490 nm: colorimetric fructose determination, 490 nm: cytotoxicity endpoint assay
- > Transmission measurement

Ordering information

Description	Order no.
Eppendorf BioSpectrometer® basic, 230 V/50 – 60 Hz	6135 000 009
Eppendorf µCuvette® G1.0 and Eppendorf BioSpectrometer® basic, 230 V/50 – 60 Hz	6135 000 904
Eppendorf BioSpectrometer® Reference Filter Set, filter set for verifying photometric accuracy and wavelength systematic error (according to NIST®)	6135 928 001
Thermal Printer DPU-S445	6135 011 000

✂ Ordering information for other voltage options begins on page 450

Eppendorf BioSpectrometer® kinetic

Description

The Eppendorf BioSpectrometer kinetic is an expansion of the Eppendorf BioSpectrometer basic and offers preprogrammed and freely programmable timed and temperature controlled assays. It features an integrated heated cuvette shaft. Its integrated peltier element guarantees high-precision for determining enzyme and substrate kinetics as well as other temperature-sensitive applications. Guided software is included; minimal effort is required to set up new assays. Retrospective modification of the time window for regression analysis can be made directly on the device. The BioSpectrometer kinetic replaces the traditional large cumbersome setup required for temperature controlled timed assays.



Product features

- > All Eppendorf BioSpectrometer basic options
- > Integrated temperature-controlled cuvette shaft (adjustment range +20 °C to +42 °C in 0.1 °C increments)
- > Integrated interval timer (minimum interval 5 s, maximum measuring time range 59 min 59 s)
- > Preprogrammed and freely programmable kinetic methods
- > Retrospective modification of the time window for regression analysis
- > Data transfer via USB interface, Ethernet or via e-mail and direct printout of results
- > Data output as *.PNG screenshots, Microsoft® Excel®, or secure PDF files to a standard USB flash drive or via email

Applications

- > All Eppendorf BioSpectrometer basic applications
- > Additional kinetic applications, and enzyme activity testings at different temperatures e.g.:
 - > Hexokinase activity measurements (340 nm, 37 °C)
 - > Determination of ATP concentration (340 nm, 37 °C)
 - > Beta-galactosidase assays (420 nm, 30 °C)

Ordering information

Description	Order no.
Eppendorf BioSpectrometer® kinetic, 230 V/50 – 60 Hz	6136 000 002
Eppendorf µCuvette® G1.0 and Eppendorf BioSpectrometer® kinetic, 230 V/50 – 60 Hz	6136 000 800
Eppendorf BioSpectrometer® Reference Filter Set, filter set for verifying photometric accuracy and wavelength systematic error (according to NIST®)	6135 928 001
Thermal Printer DPU-S445	6135 011 000

✂ Ordering information for other voltage options begins on page 450

i For more information go to www.eppendorf.com/photometry

Eppendorf BioSpectrometer® fluorescence

Description

The Eppendorf BioSpectrometer fluorescence is an expansion of the Eppendorf BioSpectrometer basic and features an integrated fluorescence module. UV/Vis assays, fluorescence assays and semi-micro/micro-volume measurements can all be carried out on a single instrument without the need for external control (PC/Laptop). Eppendorf BioSpectrometer fluorescence can be used to increase the measuring range for biomolecules (nucleic acids and proteins) by a factor of 1,000, compared to UV measurements. Pre-programmed (modified) methods for Qubit DNA quantification kits (SS, HS, BR) expand the flexibility and functionality of the instrument. Additionally, the use of the Eppendorf µCuvette G1.0 for fluorescence assays (5 µL loading volume) allows for a vast reduction in reagent usage.



Product features

- > All Eppendorf BioSpectrometer basic options
- > Preprogrammed and freely programmable fluorescence methods
- > Preprogrammed (modified) methods for Qubit DNA quantification kits (SS, HS, BR)
- > Fluorescence measurement concentration of dsDNA down to 1 pg/µL, using Pico Green®
- > Fluorescence measurement concentration of BSA down to 0.01 ng/µL
- > Fluorescence excitation wavelength 470 nm, emission wavelengths 520 nm and 560 nm
- > Fluorescence intensity across a range of 0.5 nM to 2,000 nM fluorescein
- > Single consumable (UVette) for UV/Vis and fluorescence assays
- > Data transfer via USB interface, Ethernet or via e-mail and direct printout of results
- > Data output as *.PNG screenshots, Microsoft® Excel®, or secure PDF files to a standard USB flash drive or via email

Applications

- > Ideal for NGS applications (micro-volume UV/Vis and fluorescence assays in a single instrument)
- > dsDNA quantification down to 1 pg/µL with common kits, e.g., Pico Green®
- > ssDNA quantification down to 10 pg/µL
- > RNA quantification down to 20 pg/µL
- > Oligo quantification down to 10 pg/µL
- > Protein (BSA) quantification down to 0.01 ng/µL
- > Quantification of GFP-binding proteins
- > Growth measurement of GFP-producing bacteria



www.eppendorf.com/biospectrometer-fluorescence-video

Ordering information

Description	Order no.
Eppendorf BioSpectrometer® fluorescence, 230 V/50 – 60 Hz	6137 000 006
Eppendorf µCuvette® G1.0 and Eppendorf BioSpectrometer® fluorescence, 230 V/50 – 60 Hz	6137 000 901
Eppendorf BioSpectrometer® fluorescence Reference Filter Set, filter set for verifying photometric accuracy and wavelength systematic error (according to NIST®) and verifying fluorimetric precision (random error) and linearity	6137 928 009
Thermal Printer DPU-S445	6135 011 000

✂ Ordering information for other voltage options begins on page 450



Technical Specification

Technical specifications		
Model	Eppendorf BioSpectrometer® fluorescence	Eppendorf BioSpectrometer® kinetic
Wavelength range absorption	Scan (nm): 200 – 830 at 1 nm increments	Scan (nm): 200 – 830 at 1 nm increments
Absorption measuring range	0 A – 3.0 A (260 nm)	0 A – 3.0 A (260 nm)
Random error absorption	≤0.002 at A = 0 ≤0.005 (0.5 %) at A = 1	≤0.002 at A = 0 ≤0.005 (0.5 %) at A = 1
Systematic error absorption	–	±1 % (A = 1)
Systematic error wavelength	±1 nm	±1 nm
Random error wavelength	≤0.5 nm	≤0.5 nm
dsDNA concentration range (UV 260 nm) μCuvette® G1.0	25 ng/μL – 1,500 ng/μL	25 ng/μL – 1,500 ng/μL
dsDNA concentration range (UV 260 nm) UVette® 2 mm	12.5 ng/μL – 750 ng/μL	12.5 ng/μL – 750 ng/μL
dsDNA concentration range (UV 260 nm) UVette® 10 mm	2.5 ng/μL – 150 ng/μL	2.5 ng/μL – 150 ng/μL
BSA concentration range (UV 280 nm) μCuvette® G1.0	758 ng/μL – 45,450 ng/μL	758 ng/μL – 45,450 ng/μL
BSA concentration range (UV 280 nm) UVette® 2 mm	379 ng/μL – 22,725 ng/μL	379 ng/μL – 22,725 ng/μL
BSA concentration range (UV 280 nm) UVette® 10 mm	76 ng/μL – 4,545 ng/μL	76 ng/μL – 4,545 ng/μL
Adjustable temperature range	–	20 – 42 °C (smallest step size 0.1 °C)
Systematic temperature error	–	±0.2 °C at 25 – 37 °C
Random temperature error	–	±0.15 °C at 25 – 37 °C
Measuring time range	–	00:05 – 59:59 min:sec
Interval between two measuring points	–	00:05 – 10:00 min:sec
Light source absorption	Xenon flash lamp	Xenon flash lamp
Light source fluorescence	LED	–
Measuring principle fluorescence	Confocal filter fluorometer with reference beam	–
Excitation wavelength fluorescence	470 nm, bandwidth: 25 nm	–
Emission wavelength I fluorescence	520 nm, bandwidth: 15 nm	–
Emission wavelength II fluorescence	560 nm, bandwidth: 40 nm	–
Fluorescence measuring range	0.5 nM – 2,000 nM fluorescein (emission wavelength 520 nm)	–
Random error fluorescence	±2 % at 1 nM fluorescein	–



Technical specifications		
Model	BioSpectrometer® basic	Eppendorf BioPhotometer® D30
Wavelength range absorption	Scan (nm): 200 – 830 at 1 nm increments	Fixed wavelength (nm): 230, 260, 280, 320, 340, 405, 490, 562, 595, 600
Absorption measuring range	0 A – 3.0 A (260 nm)	0 A – 3.0 A (260 nm)
Random error absorption	≤0.002 at A = 0 ≤0.005 (0.5 %) at A = 1	≤0.002 at A = 0 ≤0.005 (0.5 %) at A = 1
Systematic error absorption	±1 % (A = 1)	±1 % (A = 1)
Systematic error wavelength	±1 nm	±1 nm
Random error wavelength	≤0.5 nm	≤0.5 nm
dsDNA concentration range (UV 260 nm) μCuvette® G1.0	25 ng/μL – 1,500 ng/μL	25 ng/μL – 1,500 ng/μL
dsDNA concentration range (UV 260 nm) UVette® 2 mm	12.5 ng/μL – 750 ng/μL	12.5 ng/μL – 750 ng/μL
dsDNA concentration range (UV 260 nm) UVette® 10 mm	2.5 ng/μL – 150 ng/μL	2.5 ng/μL – 150 ng/μL
BSA concentration range (UV 280 nm) μCuvette® G1.0	758 ng/μL – 45,450 ng/μL	758 ng/μL – 45,450 ng/μL
BSA concentration range (UV 280 nm) UVette® 2 mm	379 ng/μL – 22,725 ng/μL	379 ng/μL – 22,725 ng/μL
BSA concentration range (UV 280 nm) UVette® 10 mm	76 ng/μL – 4,545 ng/μL	76 ng/μL – 4,545 ng/μL
Adjustable temperature range	–	–
Systematic temperature error	–	–
Random temperature error	–	–
Measuring time range	–	–
Interval between two measuring points	–	–
Light source absorption	Xenon flash lamp	Xenon flash lamp
Light source fluorescence	–	–
Measuring principle fluorescence	–	–
Excitation wavelength fluorescence	–	–
Emission wavelength I fluorescence	–	–
Emission wavelength II fluorescence	–	–
Fluorescence measuring range	–	–
Random error fluorescence	–	–



Model	Eppendorf μCuvette® G1.0	Eppendorf UVette®	Macro Vis Cuvette	Semi-micro Vis Cuvette
Page(s)	241	242	243	243
dsDNA concentration range (UV 260 nm)	25 ng/μL – 1,500 ng/μL	2.5 ng/μL – 750 ng/μL	1 pg/μL to 1,000 pg/μL (Pico Green Assay)	1 pg/μL to 1,000 pg/μL (Pico Green Assay)
BSA concentration range (UV 280 nm)	758 ng/μL – 45,450 ng/μL	76 ng/μL – 22,725 ng/μL	0.01 ng/μL – 0.01 μg/μL (NanoOrange Assay)	0.01 ng/μL – 0.01 μg/μL (NanoOrange Assay)
Colorimetric protein assays	yes	yes	yes	yes
OD 600 methods	no	yes	yes	yes
Fluorescence measurements	yes	yes	yes	yes
UV transparency	>180 nm	>220 nm	–	–
Light transmission	180 nm – 2,000 nm	220 nm – 1,600 nm	300 nm – 900 nm	300 nm – 900 nm
Material	quartz glass (with hydrophobic coating)	UV-transparent plastic	PMMA	PMMA
Dimensions (W × D × H)	12.5 × 12.5 × 48 mm	12.5 × 12.5 × 36 mm	12.5 × 12.5 × 45 mm	12.5 × 12.5 × 45 mm
Temperature control	no	no	yes	no
Minimum filling volume				
in Eppendorf photometers	1.5 μL	50 μL	1,000 μL	400 μL
in devices of other manufacturers	–	50 μL	2,500 μL	1,500 μL
Maximum filling volume	10 μL	2,000 μL	4,500 μL	3,000 μL
Sample light path length	1 mm	2 mm and 10 mm	10 mm	10 mm
Cuvette blank	≤0.05 A at 260 nm	≤0.5 A at 260 nm	–	–
Height of light source	8.5 mm	8.5 ¹⁾ mm	all common cell heights	all common cell heights
Use in Eppendorf BioPhotometer®	yes	yes	yes	yes
Use in Eppendorf BioSpectrometer®	yes	yes	yes	yes
Use in devices of other manufacturers	no	yes (adapters available)	yes	yes

¹⁾ (adapters available for height adjustment)

Eppendorf μCuvette® G1.0

Description

The Eppendorf μCuvette G1.0 microvolume measuring cell is a high-quality cuvette made of aluminum and quartz glass. It is the perfect tool for measuring high concentrations in small volumes. With a fixed optical path length of only 1 mm, the μCuvette G1.0 features a light path that is ten times shorter than in standard cuvettes. This allows nucleic acid and protein concentrations to be measured with high reproducibility in a much higher concentration range without prior dilution.

Due to the hydrophobic coating on the quartz glass only 1.5 μL nucleic acid or 3 μL protein sample are required for precise formation of the liquid column. Self-absorption of the μCuvette G1.0 is very low, meaning that the entire measuring range of the photometer can be used. Furthermore, 5 μL of sample solution can be used for specific fluorometric assays saving reagent.



Product features

- > Microvolume measuring cell for measuring 1.5 – 10 μL sample volumes
- > Concentration determination of nucleic acids and proteins, amongst other target analytes
- > Measurement of highly concentrated samples without prior dilution
- > Suitable for fluorescence assays
- > Low self-absorption (≤0.05 A at 260 nm)
- > Hydrophobic surface coating on quartz glass for precise formation and positioning of the sample volume
- > Simple cleaning to minimize the risk of sample carry-over
- > A defined angle for folding the sides of the cuvette guarantees reproducible handling
- > One-component hinged design prevents the loss of individual parts
- > Exclusively available for use with Eppendorf BioPhotometer and Eppendorf BioSpectrometer

Ordering information

Description	Order no.
Eppendorf μCuvette® G1.0, Microvolume measuring cell for Eppendorf BioPhotometer® and BioSpectrometer®	6138 000 018

✂ Ordering information for other voltage options begins on page 450

For more information go to www.eppendorf.com



Technical specifications subject to change.

Your local distributor: www.eppendorf.com/contact
Eppendorf AG · Barkhausenweg 1 · 22339 Hamburg · Germany · eppendorf@eppendorf.com · www.eppendorf.com · www.eppendorf.com/eshop

Eppendorf UVette®

Description

The Eppendorf UVette allows for measurements in the UV/Vis range with transparency from 220 nm to 1,600 nm with just a typical minimum volume of 50 µL. The UVette allows the user to choose between two optical path lengths (10 mm and 2 mm). The path length can be reduced by a factor of x5 without diluting or wasting any sample – simply by turning the UVette 90°. The UVette is suitable for fluorescence assays due to its low auto-fluorescence. The PCR-clean and protein-free individually sealed variant is ideal for accurate nucleic acid and protein quantification. The UVette is ideally matched for use with the Eppendorf BioPhotometer and Eppendorf BioSpectrometer families. The UVette can be used in other spectrophotometers with the aid of an adapter.

Product features

- > Suitable for measuring small volumes (≥50 µL)
- > UV and Vis measurements from 220 nm to 1,600 nm
- > UV transparent plastic, free of fluoropolymers and other halogenated hydrocarbons
- > Two built-in optical path lengths in a single cuvette - just turn the UVette 90° to change from 10 mm and 2 mm
- > Volume markings for 500 µL and 1,000 µL
- > Individually packaged and certified PCR clean and protein-free quality for sensitive (e.g. RNA) and valuable samples
- > Deep-lying optical window prevents scratches
- > Tapered cuvette base for optimal filling, frosted grip for labeling
- > Ideal for use in the Eppendorf BioPhotometer and Eppendorf BioSpectrometer, adapters available for use with other common spectrophotometers
- > Routine pack for convenient access to each UVette and safe storage in a reclosable box

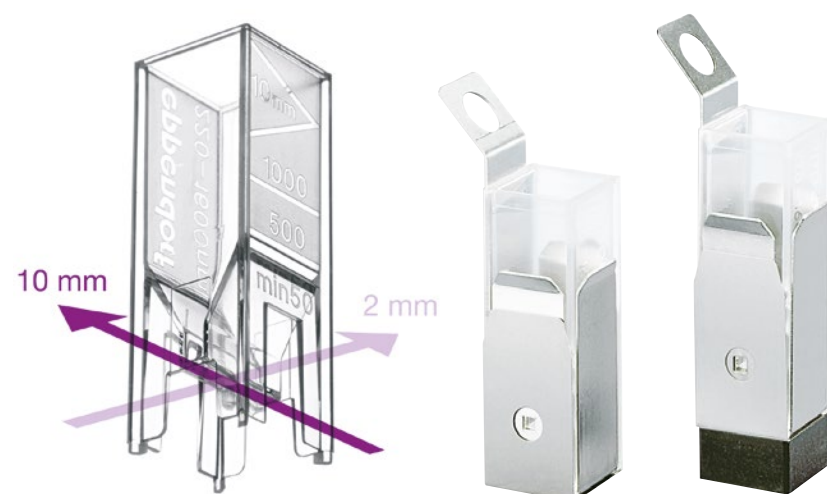

Ordering information

Description	Order no.
UVette® 220 nm – 1,600 nm , original Eppendorf plastic cuvette, individually packed, (including RNase-free, DNase-free) and protein-free, PCR clean, 50 – 2,000 µL, 80 pcs.	0030 106 300
UVette® starter set , 80 UVettes and 1 universal adapter for light path height of 15 mm and 8.5 mm, 50 – 2,000 µL	4099 100 007
UVette® routine pack 220 nm – 1,600 nm , reclosable box, Eppendorf Quality™, 200 pcs.	0030 106 318
Adapter for UVette® , for photometer/spectrophotometer with light path height	
8.5 mm	4099 001 009
10 mm	4099 002 005
15 mm	4099 003 001
20 mm	4099 005 004
Eppendorf Cuvette Rack , 30 positions, for glass and plastic cuvettes, 2 pcs., polypropylene, numbered positions, autoclavable	0030 119 851

For more information go to www.eppendorf.com/photometry

Eppendorf Vis Cuvettes



Description

The Eppendorf Vis Cuvettes are disposable cuvettes made of clear plastic with a light transmission of 300 nm to 900 nm for spectrophotometers or photometers. The Vis cuvettes are the perfect tool for applications outside of the UV range, for example, colorimetric protein assays (Bradford, Lowry, etc.), determining of the optical density of bacterial cultures (OD 600 methods), kinetic, and fluorescence measurements. Based on the volume you would like to measure, you can select semi-micro or macro cuvette.

Product features

- > Two different cuvette sizes (semi-micro and macro) for a wide variety of volumes and applications
- > Disposable cuvettes made of clear plastic with a light transmission of 300 nm to 900 nm

Ordering information

Description	Order no.
Eppendorf macro Vis Cuvette , plastic cuvette for measurements in the Vis range, max. filling volume 4,500 µL, 1,000 cuvettes (10 boxes × 100 cuvettes)	0030 079 345
Eppendorf semi-micro Vis Cuvette , plastic cuvette for measurements in the Vis range, max. filling volume 3,000 µL, 1,000 cuvettes (10 boxes × 100 cuvettes)	0030 079 353
Eppendorf Cuvette Rack , 30 positions, for glass and plastic cuvettes, 2 pcs., polypropylene, numbered positions, autoclavable	0030 119 851

Thermal Printer DPU-S445



Description

The Thermal Printer DPU-S445 is a thermal line dot printer with high printing speed while producing a clear type face. This allows the Thermal Printer DPU-S445 to print out scanned images. As an alternative to using USB sticks, the automatic print-out function of the DPU-S445 printer can be used to quickly obtain the results.

Product features

- > Automatic print-out of results
- > Easy and direct connection via USB
- > Compact and light-weight (approx. 0.5 kg)
- > Easy paper operation
- > Max. printing speed: 90 mm/sec.
- > Number of dots/line: 832
- > Resolution (dots/mm): 8

Ordering information

Description	Order no.
Thermal Printer DPU-S445	6135 011 000
Thermal paper , 5 rolls	0013 021 566

Ordering information for other voltage options begins on page 450



Eppendorf BioPhotometer® D30 Reference Filter Set



Secondary UV/Vis Eppendorf BioSpectrometer D30 Reference Filter Set: This filter set is used for verifying the photometric accuracy and wavelength systematic error on the Eppendorf BioPhotometer D30.

Product features

- > Filter traceable to NIST®
- > Filter recertification via Eppendorf (contact: Eppendorf Service)
- > Inspection protocol preprogrammed in device
- > Verification of wavelength accuracy and precision at 260 nm and 280 nm
- > Verification of the photometric accuracy and precision for selected wavelengths
- > Contains 6 filters (1 blank filter, 2 filters for checking UV/Vis wavelength systematic error and precision, 3 filters for photometric verification)

Ordering information

Description	Order no.
Eppendorf BioPhotometer® D30 Reference Filter Set, filter set for verifying photometric accuracy and wavelength systematic error (according to NIST®)	6133 928 004



Eppendorf BioSpectrometer® Reference Filter Sets



Secondary Eppendorf BioSpectrometer Fluorescence Reference Filter Set:

This filter set is used to verify photometric accuracy, wavelength systematic error, and fluorimetric precision (random error) and linearity on the Eppendorf BioSpectrometer fluorescence.

Product features

- > All features of the Eppendorf BioSpectrometer UV/Vis Reference Filter Set
- > Additional filter for verifying fluorimetric precision (random error) and linearity
- > Inspection protocol preprogrammed in device
- > 8 filters (1 blank filter, 3 filters for checking UV/Vis wavelength systematic error and precision, 3 filters for UV/Vis photometric verification, 1 filter for fluorometric verification)

Ordering information

Description	Order no.
Eppendorf BioSpectrometer® Reference Filter Set, filter set for verifying photometric accuracy and wavelength systematic error (according to NIST®)	6135 928 001
Eppendorf BioSpectrometer® fluorescence Reference Filter Set, filter set for verifying photometric accuracy and wavelength systematic error (according to NIST®) and verifying fluorimetric precision (random error) and linearity	6137 928 009

Secondary UV/Vis Eppendorf BioSpectrometer Reference Filter Set:

This filter set is used to verify photometric accuracy and wavelength systematic errors. The reference filter can be used with the Eppendorf BioSpectrometer basic and the Eppendorf BioSpectrometer kinetic.

Product features

- > Filter traceable to NIST®
- > Filter recertification via Eppendorf (contact: Eppendorf Service)
- > Inspection protocol preprogrammed in device
- > Verification of wavelength accuracy and precision at 260 nm, 280 nm and 800 nm
- > Verification of the photometric accuracy and precision in the 260 nm to 800 nm range
- > The variation coefficient is listed along with the average value of 15 measurements
- > Contains 7 filters (1 blank filter, 3 filters for checking UV/Vis wavelength systematic error and precision, 3 filters for photometric verification)

Sample Handling



Model	MC X50s	MC X50a	MC X50p	MC X50h
Page(s)	248	248	248	248
Dimensions (W x D x H)	27.5 x 43 x 33 cm	27.5 x 43 x 33 cm	27.5 x 43 x 33 cm	27.5 x 43 x 33 cm
2D-Gradient block	over 12 columns/over 8 rows	over 12 columns/over 8 rows	over 12 columns/over 8 rows	over 24 columns/over 16 rows
Gradient block	–	–	–	–
Heating rate	10 °C/s	5 °C/s	5 °C/s	5 °C/s
Cooling rate	5 °C/s	2.3 °C/s	2.3 °C/s	2.3 °C/s
Interfaces	Ethernet, USB	Ethernet, USB	Ethernet, USB	Ethernet, USB
Lid descent	flexlid® technology with TSP	flexlid® technology with TSP	flexlid® technology with TSP	flexlid® technology with TSP
Lid temperature range	37 – 110 °C	37 – 110 °C	37 – 110 °C	37 – 110 °C
Sample capacity	96-well plate or 0.1/0.2 mL tubes	96-well plate or 0.1/0.2 mL tubes	1 PCR plate (96 wells)	1 PCR plate 384
Gradient temperature range	30 – 99 °C	30 – 99 °C	30 – 99 °C	30 – 99 °C
Temperature control range of the block	4 – 99 °C	4 – 99 °C	4 – 99 °C	4 – 99 °C
Thermoblock	Silver	Aluminum	Aluminum	Aluminum
Remote Device Monitoring and Notifications (VisioNize®)	VisioNize-onboard	VisioNize-onboard	VisioNize-onboard	VisioNize-onboard

¹⁾ measured at the block

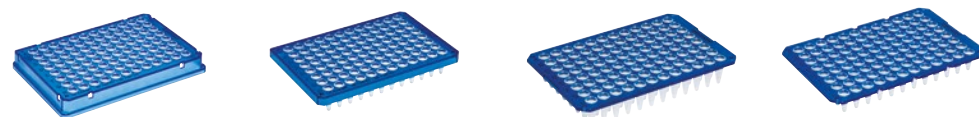

Eppendorf twin.tec® PCR Plates

Model	Eppendorf twin.tec® PCR Plate 96 skirted	Eppendorf twin.tec® PCR Plate 96 semi-skirted	Eppendorf twin.tec® PCR Plate 96 unskirted	Eppendorf twin.tec® PCR Plate 96 unskirted, divisible
Page(s)	258	258	258	259
Number of wells	96 wells	96 wells	96 wells	96 wells
Total volume per well	150 µL	250 µL	150 or 250 µL	150 or 250 µL
OptiTrack® frame color	colorless yellow green blue red	colorless blue	colorless yellow green blue red	colorless blue



Model	MC nexus GSX1	MC nexus SX1	MC nexus gradient	MC nexus	MC nexus GX2
Page(s)	252	252	252	252	253
Dimensions (W x D x H)	25 x 41.2 x 32.1 cm	25 x 41.2 x 32.1 cm	25 x 41.2 x 32.1 cm	25 x 41.2 x 32.1 cm	25 x 41.2 x 33 cm
2D-Gradient block	–	–	–	–	–
Gradient block	Over 12 rows (0.2 mL)	–	Over 12 rows (0.2 mL)	–	Over 8 rows (0.2 mL)
Heating rate	5 °C/s ¹⁾	5 °C/s ¹⁾	3 °C/s ¹⁾	3 °C/s ¹⁾	3 °C/s ¹⁾
Cooling rate	3.5 °C/s ¹⁾	3.5 °C/s ¹⁾	2 °C/s ¹⁾	2 °C/s ¹⁾	2 °C/s ¹⁾
Interfaces	CAN_in/CAN_out, Ethernet, USB	CAN_in/CAN_out, Ethernet, USB	CAN_in/CAN_out, Ethernet, USB	CAN_in/CAN_out, Ethernet, USB	CAN_in/CAN_out, Ethernet, USB
Lid descent	flexlid® technology, with TSP	flexlid® technology, with TSP	flexlid® technology, with TSP	flexlid® technology, with TSP	flexlid® technology, with TSP
Lid temperature range	37 – 110 °C	37 – 110 °C	37 – 110 °C	37 – 110 °C	37 – 110 °C
Sample capacity	96 x 0.2 mL PCR vessels, 1 PCR plate (96 wells)	96 x 0.2 mL PCR vessels, 1 PCR plate (96 wells)	96 x 0.2 mL PCR tubes, 1 PCR plate (96 wells) or 38 x 0.5 mL PCR tube positions	96 x 0.2 mL PCR tubes, 1 PCR plate (96 wells) or 38 x 0.5 mL PCR tube positions	64/32 x 0.2 mL PCR tubes or 24/10 x 0.5 mL PCR tube positions
Gradient temperature range	30 – 99 °C	–	30 – 99 °C	–	30 – 99 °C
Temperature control range of the block	4 – 99 °C	4 – 99 °C	4 – 99 °C	4 – 99 °C	4 – 99 °C
Thermoblock	Silver	Silver	Aluminum	Aluminum	Aluminum
Remote Device Monitoring and Notifications (VisioNize®)	VisioNize-qualified	VisioNize-qualified	VisioNize-qualified	VisioNize-qualified	VisioNize-qualified



Model	Eppendorf twin.tec® PCR Plate 384	Eppendorf twin.tec® PCR plate 96 LoBind	Eppendorf twin.tec® PCR Plates 384 LoBind	Eppendorf twin.tec® microbiology PCR Plate 96	Eppendorf twin.tec® 96 real-time PCR Plates
Page(s)	259	259	259	260	261
Number of wells	384 wells	96 wells	384 wells	96 wells	96 wells
Total volume per well	40 µL	150 or 250 µL	40 µL	150 or 250 µL	150 or 250 µL
OptiTrack® frame color	colorless yellow green blue red	colorless yellow green blue red	colorless	colorless blue	white blue

Mastercycler® X50

Description

The Mastercycler X50 family boasts ramp rates of up to 10 °C/s and is the ideal cycler family for routine applications as well as advanced research in molecular biology.

The Mastercycler X50 family consist of units with a user-friendly VisioNize® touchscreen interface or eco units which are externally controlled. Each cycler with a touchscreen can be networked with nine additional eco units. If that is not enough throughput, you can network up fifty Mastercycler eco units to a computer or laptop running CycleManager X50 as a central controller. Whichever you choose, you can independently control and monitor every unit. You can also manage who has access to the system and designate a level of access with our intuitive user interface. Low noise levels, low power consumption, and the versatile flexlid® concept complete the product to be a powerful and convenient PCR cycler.



Product features

- > Heating rate: 5 °C/s
- > Wide selection of blocks from a fast silver block to 384 well block
- > VisioNize touchscreen interface
- > Innovative 2D-Gradient for advanced PCR optimization
- > X50 with Touchscreen can control up to 9 other units (connected cyclers do not have a touch screen interface)
- > flexlid® concept: automatic height adjustment of the lid allows you to use all types of consumables
- > Small footprint
- > 2 Year warranty

Applications

- > Fast PCR
- > PCR optimization
- > Standard PCR
- > Incubation
- > Cycle sequencing

Ordering information

Description	Order no.
Mastercycler® X50s, 110 – 230 V/50 – 60 Hz (EU/JP/TW/US), silver block, 96-well or 0.1/0.2 mL tubes, with touchscreen interface	6311 000 010
Mastercycler® X50a, 110 – 230 V/50 – 60 Hz (EU/JP/TW/US), aluminium block, 96-well or 0.1/0.2 mL tubes, with touchscreen interface	6313 000 018
Mastercycler® X50p, 110 – 230 V/50 – 60 Hz (EU/JP/TW/US), aluminium block, 96-well, high pressure lid, with touchscreen interface	6315 000 015
Mastercycler® X50h, 110 – 230 V/50 – 60 Hz (EU/JP/TW/US), aluminium block, 384-well, high pressure lid, with touchscreen interface	6316 000 019
Mastercycler® X50i, 110 – 230 V/50 – 60 Hz (EU/JP/TW/US), silver block, 96-well or 0.1/0.2 mL tubes, eco unit	6301 000 012
Mastercycler® X50l, 110 – 230 V/50 – 60 Hz (EU/JP/TW/US), aluminium block, 96-well or 0.1/0.2 mL tubes, eco unit	6303 000 010
Mastercycler® X50r, 110 – 230 V/50 – 60 Hz (EU/JP/TW/US), aluminium block, 96-well, high pressure lid, eco unit	6305 000 017
Mastercycler® X50t, 110 – 230 V/50 – 60 Hz (EU/JP/TW/US), aluminium block, 384-well, high pressure lid, eco unit	6306 000 010

✎ Ordering information for other voltage options begins on page 450

CycleManager X50 Software



Simple, Central, Smart ...

Mastercycler X50

50x

with CycleManager X50 Software

CycleManager Software - Simple, Central, Smart

CycleManager X50 allows control of up to fifty networked Mastercycler X50 eco units. Control can be individual, simultaneous, or grouped - Perfect for high-throughput standardised protocols where reproducibility is paramount. Password protected user access is optional and users can be assigned different access rights, allowing greater documentation capabilities than ever before. It can also e-mail you when your PCR is complete!

- > Individual, simultaneous or grouped control of up to fifty cyclers
- > Verification / service reminders to ensure unverified cyclers are not used
- > Profound documentation capabilities

Note: CycleManager X50 can only be used with Mastercycler X50 eco unit variants without Touchscreen Interface.

Ordering information

Description	Order no.
CycleManager X50 Software	6349 000 014

Technical Specification Mastercycler® X50

Technical specifications				
Model	MC X50s/X50i	MC X50a/X50l	MC X50p/X50r	MC X50h/X50t
Touchscreen Interface	■/–	■/–	■/–	■/–
Unit can control 9 other units in network	■/–	■/–	■/–	■/–
Unit can only be controlled	–/■	–/■	–/■	–/■
Thermoblock	Silver	Aluminum	Aluminum	Aluminum
Sample capacity	96 × 0.2 mL PCR vessels, 1 PCR plate (96 wells)	96 × 0.2 mL PCR vessels, 1 PCR plate (96 wells)	1 PCR plate (96 wells)	1 PCR plate (384 wells)
96-well plate	■	■	■	–
384-well plate	–	–	–	■
0.1/0.2 mL tubes	■	■	–	–
Heating technology	Six peltier elements	Six peltier elements	Six peltier elements	Six peltier elements
2D-Gradient block	over 12 columns/over 8 rows	over 12 columns/over 8 rows	over 12 columns/over 8 rows	over 24 columns/over 16 rows
Temperature control mode	Fast, Intermediate, Standard, Safe	Fast, Intermediate, Standard, Safe	Fast, Intermediate, Standard, Safe	Fast, Intermediate, Standard, Safe
Temperature control range of the block	4 – 99 °C	4 – 99 °C	4 – 99 °C	4 – 99 °C
Gradient range	1 – 30 °C	1 – 30 °C	1 – 30 °C	1 – 30 °C
Gradient temperature range	30 – 99 °C	30 – 99 °C	30 – 99 °C	30 – 99 °C
Block homogeneity 20–72 °C	≤ ±0.2 °C	≤ ±0.2 °C	≤ ±0.2 °C	≤ ±0.2 °C
Block homogeneity 95 °C	≤ ±0.3 °C	≤ ±0.3 °C	≤ ±0.3 °C	≤ ±0.3 °C
Control accuracy	±0.15 °C	±0.15 °C	±0.15 °C	±0.15 °C
Heating rate	10 °C/s	5 °C/s	5 °C/s	5 °C/s/5 °C/s
Cooling rate	5 °C/s	2.3 °C/s	2.3 °C/s	2.3 °C/s
Lid descent	flexlid® technology with TSP	flexlid® technology with TSP	flexlid® technology with TSP	flexlid® technology with TSP
High pressure lid	–	–	■	■
Lid temperature range	37 – 110 °C	37 – 110 °C	37 – 110 °C	37 – 110 °C
Interfaces	Ethernet, USB	Ethernet, USB	Ethernet, USB	Ethernet, USB
Power supply	110 – 230 V, 50 – 60 Hz	110 – 230 V, 50 – 60 Hz	110 – 230 V, 50 – 60 Hz	110 – 230 V, 50 – 60 Hz
Max. power consumption	850 W	850 W	850 W	850 W
Total weight	11.5 kg/10.7 kg	11.5 kg/10.7 kg	11.5 kg/10.7 kg	11.5 kg/10.7 kg
Dimensions (W x D x H)	27.5 x 43 x 33 cm	27.5 x 43 x 33 cm	27.5 x 43 x 33 cm	27.5 x 43 x 33 cm



This icon tags VisioNize-onboard devices which can be conveniently connected to VisioNize for device monitoring and notifications customizable to meet your needs.

Further information are available at page 11.

Temperature Verification System T6 - Multi Channel

Description

To safeguard reproducibility of PCR results, continuous surveillance and documentation of the cycler performance is beneficial. Eppendorf offers a range of service plans to meet the requirements of different needs. We continue to support our customers beyond the point of purchase: We also offer customers the opportunity to buy our Temperature Verification System to monitor critical factors in success or failure of PCR reactions independently/in house.

The new Temperature Verification System can assess, verify and where necessary, adjust the Mastercycler X50 family as well as most other Mastercycler families regarding temperature accuracy. Minimum user input during verification ensures the integrity of the measurement, data and certificates it produces. Data and certificates can be exported via USB for archiving.



Ordering information

Description	Order no.
Temperature Verification System T6, without thermal sensors	6328 006 500
Sensor unit for 96 well blocks, calibrated in an ISO 9001 certified laboratory	6328 007 000
Sensor unit for 96 well blocks, calibrated in an ISO 17025 accredited laboratory	6328 007 507
Sensor unit for 384 well blocks, calibrated in an ISO 9001 certified laboratory	6328 008 007
Sensor unit for 384 well blocks, calibrated in an ISO 17025 accredited laboratory	6328 008 503
Sensor unit flat, calibrated in an ISO 9001 certified laboratory	6328 009 003
Sensor unit flat, calibrated in an ISO 17025 accredited laboratory	6328 009 500

Mastercycler® nexus

Description

The Mastercycler Nexus PCR cycler provides scientists with flexibility in many forms. The 96 well aluminium block can accommodate several standard vessel types from 0.2 mL tubes to 96 well plates, there is no need to buy additional blocks. The silver block variants provide faster ramp rates than the aluminum blocks. Up to 2 eco cyclers can be connected to a programmable cycler and the configuration can also include the nexus X2 eco units, to provide a maximum of 6 independent blocks. The flexlid provides effortless height adjustment for different vessels. The Mastercycler Nexus cycler can even email you when the PCR run is complete – what else do you need from a PCR cycler?



Product features

- > Intuitive graphic programming
- > Small footprint
- > Universal block for ultimate flexibility
- > Connect up to 2 Mastercycler nexus eco to your existing unit
- > Available with gradient
- > E-mail notification
- > flexlid® concept allows use of all types of consumables with automatic height adjustment of the lid

Applications

- > Standard PCR
- > Fast PCR
- > Optimizing a PCR
- > *In situ* PCR

Ordering information

Description	Order no.
Mastercycler® nexus GSX1, 230 V/50 – 60 Hz	6345 000 010
Mastercycler® nexus SX1, 230 V/50 – 60 Hz	6346 000 013
Mastercycler® nexus GSX1e, 230 V/50 – 60 Hz	6347 000 017
Mastercycler® nexus SX1e, 230 V/50 – 60 Hz	6348 000 010
Mastercycler® nexus gradient, 230 V/50 – 60 Hz	6331 000 017
Mastercycler® nexus, 230 V/50 – 60 Hz	6333 000 014
Mastercycler® nexus gradient eco, 230 V/50 – 60 Hz	6334 000 018
Mastercycler® nexus eco, 230 V/50 – 60 Hz	6332 000 010
Mastercycler® nexus flat, 230 V/50 – 60 Hz	6335 000 011
Mastercycler® nexus flat eco, 230 V/50 – 60 Hz	6330 000 013
CAN bus connecting cable, 150 cm	5341 611 000
CAN bus connecting cable, 50 cm	5341 612 006

⚡ Ordering information for other voltage options begins on page 450

ℹ For more information go to www.eppendorf.com/Mastercycler

Mastercycler® nexus X2

Description

The Mastercycler nexus X2 gives you the ability to run two totally independent protocols at the same time. Smaller assays fit nicely on the 32-well-block – larger assays can exceed 48 samples and run on the 64-well-block. The larger block is available with a gradient function. As every member of the Mastercycler nexus family, the Mastercycler nexus X2 can be combined with all other family members in a network of up to 3 units. In combination with Eppendorf's PCR Tubes, PCR Strips or divisible plates, the Mastercycler nexus X2 will give you consistent and publishable results – every day!



Product features

- > Large block for large assays – small block for small assays
- > Intuitive graphic programming
- > Universal block for strips, 0.1 mL, 0.2 mL and 0.5 mL PCR tubes
- > Small footprint
- > Optional gradient for PCR optimization
- > E-mail notification
- > flexlid® concept allows use of all types of consumables with automatic height adjustment of the lid

Applications

- > Standard PCR
- > Optimizing a PCR

Ordering information

Description	Order no.
Mastercycler® nexus GX2, 230 V/50 – 60 Hz	6336 000 015
Mastercycler® nexus GX2e, 230 V/50 – 60 Hz	6338 000 012
Mastercycler® nexus X2, 230 V/50 – 60 Hz	6337 000 019
Mastercycler® nexus X2e, 230 V/50 – 60 Hz	6339 000 016

⚡ Ordering information for other voltage options begins on page 450



www.eppendorf.com/nexus-x2-brochure

ℹ For more information go to www.eppendorf.com/pcr



Technical Specification Mastercycler® nexus

Technical specifications			
Model	MC nexus GSX1/GSX1e	MC nexus SX1/SX1e	MC nexus gradient/gradient eco
Unit can control 2 other units in network	■/–	■/–	■/–
Unit can only be controlled ¹⁾	–/■	–/■	–/■
Thermoblock	Silver	Silver	Aluminum
Sample capacity	96 × 0.2 mL PCR vessels, 1 PCR plate (96 wells)	96 × 0.2 mL PCR vessels, 1 PCR plate (96 wells)	96 × 0.2 mL PCR tubes, 1 PCR plate (96 wells) or 38 × 0.5 mL PCR tube positions
Heating technology	Peltier elements, triple circuit technology	Peltier elements, triple circuit technology	Peltier elements, Triple Circuit Technology
Gradient block	Over 12 rows (0.2 mL)	–	Over 12 rows (0.2 mL)
Gradient temperature range	30 – 99 °C	–	30 – 99 °C
Gradient range	1 – 20 °C	–	1 – 20 °C
Temperature control mode	Fast, standard, safe	Fast, standard, safe	Fast, standard, safe
Temperature control range of the block	4 – 99 °C	4 – 99 °C	4 – 99 °C
Intuitive graphic programming	■/–	■/–	■/–
Block homogeneity 20–72 °C	≤ ±0.3 °C	≤ ±0.3 °C	≤ ±0.3 °C
Control accuracy	±0.2 °C	±0.2 °C	±0.2 °C
E-mail Notification	■	■	■
2 years warranty	■	■	■
USB port	■/–	■/–	■/–
Block homogeneity 90 °C	≤ ±0.4 °C	≤ ±0.4 °C	≤ ±0.4 °C
Heating rate	5 °C/s ²⁾	5 °C/s ²⁾	3 °C/s ²⁾
Cooling rate	3.5 °C/s ²⁾	3.5 °C/s ²⁾	2 °C/s ²⁾
Lid descent	flexlid® technology with TSP	flexlid® technology with TSP	flexlid® technology with TSP
Lid temperature range	37 – 110 °C	37 – 110 °C	37 – 110 °C
Interfaces	CAN_in/CAN_out, Ethernet, USB	CAN_in/CAN_out, Ethernet, USB	CAN_in/CAN_out, Ethernet, USB
Power supply	230 V, 50 – 60 Hz	230 V, 50 – 60 Hz	230 V, 50 – 60 Hz
Max. power consumption	540 W	540 W	700 W
Total weight	10.9 kg	10.9 kg	10.9 kg
Dimensions (W × D × H)	25 × 41.2 × 32.1 cm	25 × 41.2 × 32.1 cm	25 × 41.2 × 32.1 cm
Number of programs on device	> 700	> 700	> 700

¹⁾ Control through a Mastercycler® nexus, Mastercycler® nexus gradient, Mastercycler® nexus GSX1, Mastercycler® nexus SX1, Mastercycler® nexus GX2, Mastercycler® nexus X2 or Mastercycler® nexus flat ²⁾ measured at the block

Technical specifications		
Model	MC nexus/nexus eco	MC nexus flat/flat eco
Unit can control 2 other units in network	■/–	■/–
Unit can only be controlled ¹⁾	–/■	–/■
Thermoblock	Aluminum	Aluminum
Sample capacity	96 × 0.2 mL PCR tubes, 1 PCR plate (96 wells) or 38 × 0.5 mL PCR tube positions	4 slides or other matching consumables
Heating technology	Peltier elements, triple circuit technology	Peltier elements, triple circuit technology
Gradient block	–	–
Gradient temperature range	–	–
Gradient range	–	–
Temperature control mode	Fast, standard, safe	Fast, standard, safe
Temperature control range of the block	4 – 99 °C	4 – 99 °C
Intuitive graphic programming	■/–	■/–
Block homogeneity 20–72 °C	≤ ±0.3 °C	≤ ±0.3 °C
Control accuracy	±0.2 °C	±0.2 °C
E-mail Notification	■	■
2 years warranty	■	■
USB port	■/–	■/–
Block homogeneity 90 °C	≤ ±0.4 °C	≤ ±0.4 °C
Heating rate	3 °C/s ²⁾	3 °C/s ²⁾
Cooling rate	2 °C/s ²⁾	2 °C/s ²⁾
Lid descent	flexlid® technology with TSP	flexlid® technology with TSP
Lid temperature range	37 – 110 °C	37 – 110 °C
Interfaces	CAN_in/CAN_out, Ethernet, USB	CAN_in/CAN_out, Ethernet, USB
Power supply	230 V, 50 – 60 Hz	230 V, 50 – 60 Hz
Max. power consumption	700 W/540 W	700 W/540 W
Total weight	10.9 kg	10.4 kg
Dimensions (W × D × H)	25 × 41.2 × 32.1 cm	25 × 41.2 × 32.1 cm
Number of programs on device	> 700	> 700

¹⁾ Control through a Mastercycler® nexus, Mastercycler® nexus gradient, Mastercycler® nexus GSX1, Mastercycler® nexus SX1, Mastercycler® nexus GX2, Mastercycler® nexus X2 or Mastercycler® nexus flat ²⁾ measured at the block

Technical Specification Mastercycler® nexus X2

Technical specifications		
Model	MC nexus GX2/GX2e	MC nexus X2/X2e
Unit can control 2 other units in network	■/–	■/–
Unit can only be controlled1)	–/■	–/■
Thermoblock	Aluminum	Aluminum
Sample capacity	64/32 × 0.2 mL PCR tubes or 24/10 × 0.5 mL PCR tube positions	64/32 × 0.2 mL PCR tubes or 24/10 × 0.5 mL PCR tube positions
Heating technology	Peltier elements, Triple Circuit Technology	Peltier elements, Triple Circuit Technology
Gradient block	Over 8 rows (0.2 mL)/Over 8 rows	–
Gradient temperature range	30 – 99 °C/30 – 99 °C	–
Gradient range	1 – 12 °C/1 – 12 °C	–
Temperature control mode	Fast, Standard, Safe	Fast, Standard, Safe
Temperature control range of the block	4 – 99 °C	4 – 99 °C
Intuitive graphic programming	■/–	■/–
Block homogeneity 20–72 °C	≤ ±0.3 °C	≤ ±0.3 °C
Control accuracy	±0.2 °C	±0.2 °C
E-mail Notification	■	■
2 years warranty	■	■
USB port	■/–	■/–
Block homogeneity 90 °C	≤ ±0.4 °C	≤ ±0.4 °C
Heating rate	3 °C/s ²⁾	3 °C/s ²⁾
Cooling rate	2 °C/s ²⁾	2 °C/s ²⁾
Lid descent	flexlid® technology with TSP	flexlid® technology with TSP
Lid temperature range	37 – 110 °C	37 – 110 °C
Interfaces	CAN_in/CAN_out, Ethernet, USB/CAN_in/CAN_out, Ethernet	CAN_in/CAN_out, Ethernet, USB/CAN_in/CAN_out, Ethernet
Max. power consumption	700 W	700 W
Total weight	10.5 kg	11 kg
Dimensions (W × D × H)	25 × 41.2 × 33 cm	25 × 41.2 × 33 cm
Number of programs on device	> 700	> 700

¹⁾ Control through a Mastercycler® nexus, Mastercycler® nexus gradient, Mastercycler® nexus GSX1, Mastercycler® nexus SX1, Mastercycler® nexus GX2, Mastercycler® nexus X2 or Mastercycler® nexus flat
²⁾ measured at the block



www.eppendorf.com/nexus-x2-info

For more information go to www.eppendorf.com/Mastercycler

Technical specifications subject to change.

HeatSealer



HeatSealer S100 and S200

- > Hermetic sealing of multiwell plates
- > Fixed sealing temperature for reproducible results (S100)
- > Adjustable sealing temperatures for more flexibility (S200)
- > Eliminates evaporation in PCR, reducing cross contamination
- > Seals 96- and 384-well plates
- > Compact design, portable device
- > Integrated thermostats prevents overheating
- > Improved mechanics for even easier sealing
- > PCR Plate Adapter included

Ordering information

Description	Order no.
HeatSealer S100, incl. PCR Plate Adapter, 100 – 230 V/50 – 60 Hz	5391 000 001
HeatSealer S200, incl. PCR Plate Adapter, 100 – 230 V/50 – 60 Hz	5392 000 005
Plate Adapter low profile, for HeatSealer S100	5391 070 018
Plate Adapter high profile, for HeatSealer S100	5391 070 034
96-well-PCR Plate Adapter, for HeatSealer S100	5391 070 026
Plate Adapter high profile, for HeatSealer S200	5392 070 011
Plate Adapter low profile, for HeatSealer S200	5392 070 020
96-well Plate Adapter, for HeatSealer S200	5392 070 038
Eppendorf Heat Sealing Film, PCR clean, 100 pcs.	0030 127 838
Eppendorf Heat Sealing Foil, PCR clean, 100 pcs.	0030 127 854

Ordering information for other voltage options begins on page 450

Your local distributor: www.eppendorf.com/contact

Eppendorf AG · Barkhausenweg 1 · 22339 Hamburg · Germany · eppendorf@eppendorf.com · www.eppendorf.com · www.eppendorf.com/eshop

Eppendorf twin.tec® PCR Plates

Product features

- > One-piece design: combining a polycarbonate frame and polypropylene wells for optimum performance
- > Extremely thin-walled polypropylene wells guarantee optimum heat transfer to the sample
- > Exceptionally solid and torque-resistant polycarbonate frame
- > Improved well-to-well tolerance
- > Cut-away corner and alphanumeric grid-referencing
- > Raised well rims for effective sealing, also reduces risk of cross-contamination
- > Certified free of any detectable human DNA, DNase, RNase and PCR inhibitors¹⁾
- > Available with barcode (upon request), for skirted and semi-skirted only
- > Ideal for quantitative real-time PCR as well

¹⁾ Download of certificates under www.eppendorf.com/certificates



Eppendorf twin.tec® PCR Plate 96, skirted

- > Optimized rim for barcodes and automated work processes
- > Within SBS footprint recommendations (127.76 × 85.47 mm ±0.25 mm)
- > Stackable
- > Eight holes in the skirt aid plate positioning and removal from the thermal cycler block
- > Low profile design enhances efficiency of PCR and enables the highest efficiency for small sample volumes
- > 150 µL max. well volume (when used with cap strips)
- > Available with barcode (upon request)
- > Ideal for quantitative real-time PCR as well – OptiTrack® matrix for faster sample identification and fewer pipetting errors

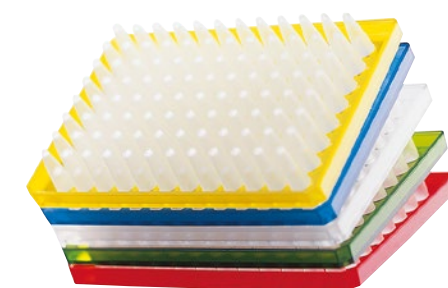

Eppendorf twin.tec® PCR Plate 96, semi-skirted

- > Semi-skirted for label and barcode
- > Fits most thermal cyclers
- > 250 µL max. well volume (when used with cap strips)
- > Improved well-to-well tolerance
- > Available with barcode (upon request)
- > Ideal for quantitative real-time PCR as well – OptiTrack® matrix for faster sample identification and fewer pipetting errors

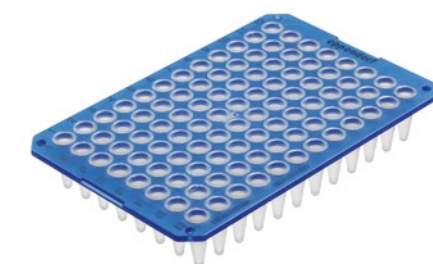

Eppendorf twin.tec® PCR Plate 96, unskirted

- > Fits even more thermal cyclers
- > OptiTrack® matrix for faster sample identification and fewer pipetting errors
- > Available with regular (250 µL) or low profile (150 µL) wells
- > Ideal for quantitative real-time PCR as well



Eppendorf twin.tec® PCR Plate 96, unskirted, divisible

- > Can be divided in 4 segments of 24 wells each
- > Fits most common thermal cyclers
- > OptiTrack® matrix for faster sample identification and fewer pipetting errors
- > Available with regular (250 µL) or low profile (150 µL) wells
- > Can be divided into 4 segments of 24 wells each to prevent waste and save money
- > Ideal for quantitative real-time PCR as well



Eppendorf twin.tec® microbiology PCR Plate 96

- > Individually blistered
- > Certified PCR clean
- > Additionally free of bacterial DNA
- > For all applications that need ultimate purity or certified absence of bacterial DNA
- > Available with barcode (upon request), for skirted and semi-skirted only
- > Ideal for quantitative real-time PCR as well – OptiTrack® matrix for faster sample identification and fewer pipetting errors



Eppendorf twin.tec® PCR Plate 384

- > Optimized rim for barcodes and automated work processes
- > Stackable
- > Within SBS footprint recommendations
- > Ideal for most common 384-well thermocyclers, particularly for Eppendorf Mastercycler X50 and Mastercycler nexus
- > 40 µL max. well volume
- > Available with barcode (upon request), for skirted and semi-skirted only
- > Ideal for quantitative real-time PCR as well – OptiTrack® matrix for faster sample identification and fewer pipetting errors



Eppendorf twin.tec® PCR Plate 96 and 384 LoBind

- > Maximum recovery rates for improved assay results
- > Available with barcode (upon request)
- > Ideal for quantitative real-time PCR as well
- > Exceptionally solid and torque-resistant polycarbonate frame
- > OptiTrack® matrix for faster sample identification and fewer pipetting errors
- > Raised well rims for effective sealing, also reduces risk of cross-contamination
- > Batch-tested and certified free of DNA, DNAase, RNase and PCR inhibitors (PCR clean)

► For more Assay/Reader MTPs go to page 108

Eppendorf twin.tec® PCR Plates

Ordering information	
Description	Order no.
Eppendorf twin.tec® PCR Plate 96 , skirted, 150 µL	
PCR clean, colorless, 25 plates	0030 128 648
PCR clean, yellow, 25 plates	0030 128 656
PCR clean, green, 25 plates	0030 128 664
PCR clean, blue, 25 plates	0030 128 672
PCR clean, red, 25 plates	0030 128 680
Forensic DNA Grade, colorless, 10 plates, individually wrapped	0030 129 601
Eppendorf twin.tec® PCR Plate 96 , semi-skirted, 250 µL	
PCR clean, colorless, 25 plates	0030 128 575
PCR clean, yellow, 25 plates	0030 128 583
PCR clean, green, 25 plates	0030 128 591
PCR clean, blue, 25 plates	0030 128 605
PCR clean, red, 25 plates	0030 128 613
Forensic DNA Grade, colorless, 10 plates, individually wrapped	0030 129 610
Eppendorf twin.tec® PCR Plate 96, low profile , unskirted, 150 µL	
PCR clean, colorless, 20 plates	0030 133 307
PCR clean, blue, 20 plates	0030 133 331
Eppendorf twin.tec® PCR Plate 96 , unskirted, 250 µL	
PCR clean, colorless, 20 plates	0030 133 366
PCR clean, blue, 20 plates	0030 133 390
Eppendorf twin.tec® PCR Plate 96 , divisible, unskirted, 150 µL	
PCR clean, colorless, 20 plates	0030 133 358
PCR clean, blue, 20 plates	0030 133 382
Eppendorf twin.tec® PCR Plate 96 , divisible, unskirted, 250 µL	
PCR clean, colorless, 20 plates	0030 133 374
PCR clean, blue, 20 plates	0030 133 404
Eppendorf twin.tec® microbiology PCR Plate 96 , skirted, 150 µL	
PCR clean, colorless, 10 plates	0030 129 300
PCR clean, blue, 10 plates	0030 129 318
Eppendorf twin.tec® microbiology PCR Plate 96 , semi-skirted, 250 µL	
PCR clean, colorless, 10 plates	0030 129 326
PCR clean, blue, 10 plates	0030 129 334
Eppendorf twin.tec® microbiology PCR Plate 384 , skirted, 40 µL	
PCR clean, colorless, 10 plates	0030 129 342
PCR clean, blue, 10 plates	0030 129 350
Eppendorf twin.tec® PCR Plate 384 , skirted, 40 µL	
PCR clean, colorless, 25 plates	0030 128 508
PCR clean, yellow, 25 plates	0030 128 516
PCR clean, green, 25 plates	0030 128 524
PCR clean, blue, 25 plates	0030 128 532
PCR clean, red, 25 plates	0030 128 540
Forensic DNA Grade, colorless, 10 plates, individually wrapped	0030 129 628
Eppendorf twin.tec® PCR plate 96 LoBind , semi-skirted, 250 µL	
PCR clean, colorless, 25 plates	0030 129 504
Eppendorf twin.tec® PCR plate 96 LoBind , skirted, 150 µL	
PCR clean, colorless, 25 plates	0030 129 512
PCR clean, blue, 25 plates	0030 129 580
PCR clean, green, 25 plates	0030 129 660
PCR clean, red, 25 plates	0030 129 598
PCR clean, yellow, 25 plates	0030 129 679
Eppendorf twin.tec® PCR plate 384 LoBind , skirted, 40 µL	
PCR clean, colorless, 25 plates	0030 129 547

For more information go to www.eppendorf.com/Twintec

Eppendorf twin.tec® *real-time* PCR Plates



Eppendorf twin.tec® 96 *real-time* PCR Plates

- > White wells for better reflection
- > High mechanical stability
- > Raised rims for effective sealing
- > Skirted and semi-skirted frames
- > Optimal heat transfer due to reduced wall thickness
- > Autoclavable (121 °C, 20 min)
- > Available with barcode (upon request)

Ordering information	
Description	Order no.
Eppendorf twin.tec® 96 <i>real-time</i> PCR Plate , skirted, 150 µL	
PCR clean, blue, wells white, 25 plates	0030 132 505
PCR clean, white, wells white, 25 plates	0030 132 513
Eppendorf twin.tec® 96 <i>real-time</i> PCR Plate , semi-skirted, 250 µL	
PCR clean, blue, wells white, 25 plates	0030 132 530
PCR clean, white, wells white, 25 plates	0030 132 548
Eppendorf twin.tec® 96 <i>real-time</i> PCR Plate, low profile , unskirted, 150 µL	
PCR clean, white, wells white, 20 plates	0030 132 700
PCR clean, blue, wells white, 20 plates	0030 132 718
Eppendorf twin.tec® 96 <i>real-time</i> PCR Plate , skirted, 150 µL	
Forensic DNA Grade, white, wells white, 10 plates, individually wrapped	0030 129 636
Eppendorf twin.tec® 96 <i>real-time</i> PCR Plate , semi-skirted, 250 µL	
Forensic DNA Grade, white, wells white, 10 plates, individually wrapped	0030 129 644

Eppendorf Fast PCR Tube Strips



Description

The Fast PCR Tube Strip allows scientists using Fast cyclers (such as the Mastercycler X50) and Fast enzymes to obtain higher PCR yield. This is achieved by the faster heat transfer from block to reaction, allowing for better control over the reaction. The Tube-strips are suitable for Fast end-point PCR and Real-Time PCR applications. The open format tube strip allows easy adoption and easy optimization.

Eppendorf Fast PCR Tube Strips

- > Ideal for use with Fast cyclers such as the Mastercycler X50s and Fast enzymes
- > 8 reaction tubes in strip-format – ideal for small sample volumes
- > Easily adaptable for automation
- > Sealable using flat or domed strip-lids
- > Certified free from human DNA, DNase, RNase and PCR inhibitors¹⁾

¹⁾ Download of certificates under www.eppendorf.com/certificates

Ordering information	
Description	Order no.
Eppendorf Fast PCR Tube Strips	
0.1 mL, without lids, PCR clean, 120 pcs. (10 × 12 pcs.)	0030 124 901
0.1 mL, with cap strips, flat, PCR clean, 120 pcs. (10 × 12 pcs.)	0030 124 910
0.1 mL, with cap strips, domed, PCR clean, 120 pcs. (10 × 12 pcs.)	0030 124 928

Eppendorf PCR Tube Strips



Eppendorf PCR Tube Strips

- > 8 reaction tubes in strip-format – ideal for small sample volumes
- > Easily adaptable for automation
- > Sealable using flat or domed strip-lids
- > Certified free from human DNA, DNase, RNase and PCR inhibitors¹⁾

¹⁾ Download of certificates under www.eppendorf.com/certificates

Ordering information

Description	Order no.
Eppendorf PCR Tube Strips, 0.1 mL	
PCR clean, without lids (10 × 12 strips)	0030 124 804
PCR clean, with Cap Strips, domed (10 × 12 strips)	0030 124 812
PCR clean, with Cap Strips, flat (10 × 12 strips)	0030 124 820
Eppendorf PCR Tubes, 0.2 mL	
PCR clean, 8-tube strips, 120 pcs. (960 tubes)	0030 124 359

Eppendorf PCR Tubes



Eppendorf PCR Tubes

- > Contamination shield on hinged lid
- > Defined lid position due to special hinge
- > High transparency even on the tube base
- > Etched lid for labeling
- > Tight sealing
- > Easy to open
- > For use with all thermal cyclers with 0.2 mL block format
- > Also available in 8-tube strip format
- > Certified free from human DNA, DNase, RNase and PCR inhibitors¹⁾

¹⁾ Download of certificates under www.eppendorf.com/certificates

Ordering information

Description	Order no.
Eppendorf PCR Tubes, 0.2 mL	
PCR clean, colorless, 1,000 pcs.	0030 124 332
Forensic DNA Grade, colorless, 500 pcs. (10 bags × 50 pcs.)	0030 124 707
PCR clean, 8-tube strips, 120 pcs. (960 tubes)	0030 124 359

For more information go to www.eppendorf.com/pcr

Technical specifications subject to change.

Eppendorf PCR Tubes, 0.5 mL



Eppendorf PCR Tubes, 0.5 mL

- > Etched lid for labeling
- > Tight sealing
- > Easy to open
- > For use with all thermal cyclers with 0.5 mL block format
- > Certified free from human DNA, DNase, RNase and PCR inhibitors¹⁾

¹⁾ Download of certificates under www.eppendorf.com/certificates

Ordering information

Description	Order no.
Eppendorf PCR Tubes, 0.5 mL, PCR clean, with hinged lid, clear, 500 pcs.	0030 124 537

Cap Strips



Cap Strips

- > Strips with eight microcaps for 0.1 and 0.2 mL wells
- > Easy and rapid sealing of Eppendorf twin.tec PCR Plates, PCR strips and other standard multiwell plates
- > Flat Cap Strips are suitable for real-time PCR
- > Autoclavable (121 °C, 20 min)
- > Certified free from human DNA, DNase, RNase and PCR inhibitors¹⁾

¹⁾ Download of certificates under www.eppendorf.com/certificates

Ordering information

Description	Order no.
Cap Strips, 8-strips, domed	
120 pcs. (10 bags × 12 pcs.)	0030 124 839
Cap Strips, 8-strips, flat	
120 pcs. (10 × 12 pcs.)	0030 124 847

Your local distributor: www.eppendorf.com/contact

Eppendorf AG · Barkhausenweg 1 · 22339 Hamburg · Germany · eppendorf@eppendorf.com · www.eppendorf.com · www.eppendorf.com/eshop

Masterclear® Cap Strips and *real-time* PCR Tube Strips



Masterclear® Cap Strips and *real-time* PCR Tube Strips

real-time PCR Tube Strips

- > White wells for better reflection
- > High mechanical stability
- > Extremely thin walls for optimal heat transfer
- > Certified free from human DNA, DNase, RNase and PCR inhibitors¹⁾

Masterclear Cap Strips

- > Inverted dome to avoid scratching of the optic surface
- > Inverted dome to reduce volume of the tubes
- > Optimized for maximum light transmission
- > Certified free from human DNA, DNase, RNase and PCR inhibitors¹⁾

¹⁾ Download of certificates under www.eppendorf.com/certificates

Ordering information

Description	Order no.
<i>real-time</i> PCR Tube Strips, without caps	
120 pcs. (10 × 12 pcs.)	0030 132 882
Masterclear Cap Strips and <i>real-time</i> PCR Tube Strips	
120 pcs. (10 × 12 pcs.)	0030 132 890
Masterclear Cap Strips	
120 pcs. (10 × 12 pcs.)	0030 132 874

Heat Sealing Film and Heat Sealing Foil



Heat Sealing Film and Heat Sealing Foil

- > Hermetic sealing of multiwell plates, especially recommended for low reaction volumes
- > Best protection against evaporation during PCR
- > Maximum adhesiveness at high temperatures during PCR

Ordering information

Description	Order no.
Eppendorf Heat Sealing Film, PCR clean, 100 pcs.	0030 127 838
Eppendorf Heat Sealing Foil, PCR clean, 100 pcs.	0030 127 854

For more information go to www.eppendorf.com/pcr

PCR Film (self-adhesive) and PCR Foil (self-adhesive)



PCR Film (self-adhesive) and PCR Foil (self-adhesive)

- > Effective adhesive sealing prevents evaporation loss during PCR
- > Removal from the plate with no residue
- > PCR Film: Sample can be visually monitored through the transparent film
- > PCR Foil: Easily pierced
- > PCR Foil: No sticking of the pipette tip (ideal for automated systems)

Ordering information

Description	Order no.
Eppendorf PCR Film, self-adhesive, PCR clean, 100 pcs.	0030 127 781
Eppendorf PCR Foil, self-adhesive, PCR clean, 100 pcs.	0030 127 790

Masterclear® *real-time* PCR Film



Masterclear® *real-time* PCR Film

- > Optimized for maximum light transmission
- > Optimized for tight sealing
- > Optimized packaging for your convenience

Ordering information

Description	Order no.
Masterclear® <i>real-time</i> PCR Film, self-adhesive, PCR clean, 100 pcs.	0030 132 947

PCR Rack



PCR Rack

- > Rack for handling and storing tubes and plates
- > For 0.1 mL, 0.2 mL and 0.5 mL tubes, as well as 96-well plates
- > Stackable
- > Can be stored down to -90 °C
- > Autoclavable (121 °C, 20 min)

Ordering information

Description	Order no.
PCR Rack, 10 pcs.	0030 124 545

Sample Handling



Model	CryoCube® F740hi, 3 c./ CryoCube® F740hi, 5 c.	CryoCube® F740hiw, 3 c./ CryoCube® F740hiw, 5 c.	CryoCube® F740h, 3c./ CryoCube® F740h, 5c.
Page(s)	272/278	272/278	272/278
Insulation	Vacuum insulation paneling / polyurethane foam	Vacuum insulation paneling / polyurethane foam	Vacuum insulation paneling / polyurethane foam
Wall Thickness	Type B	Type B	Type B
Capacity	740 L	740 L	740 L
No. of internal doors	3	3	3
No. of compartments	3/5	3/5	3/5
Max. racks per freezer	18/30	18/30	18/30
Box capacity per rack			
53 mm (2 in) tall boxes	32/16	32/16	32/16
76 mm (3 in) tall boxes	20/8	20/8	20/8
127 mm (5 in) tall boxes	12	12	12
Box capacity per freezer			
53 mm (2 in) tall boxes	576/528	576/528	576/528
76 mm (3 in) tall boxes	360/288	360/288	360/288
102 mm (4 in) tall boxes	288/264	288/264	288/264
Sample capacity			
53 mm (2 in) tall boxes	57,600/52,800	57,600/52,800	57,600/52,800
Dimensions (W x D x H) ¹⁾²⁾³⁾	109.9 x 98 x 197.3 cm	109.9 x 98 x 197.3 cm	109.9 x 91.5 x 197.3 cm
Dimensions internal (W x D x H)	86.5 x 62.1 x 139 cm	86.5 x 62.1 x 139 cm	86.5 x 62.1 x 139 cm
Weight w/o accessories	315 kg/333 kg	320 kg/328 kg	308 kg/317 kg
Shipping weight	364 kg/382 kg	369 kg/377 kg	357 kg/366 kg
Pull-down time to -80 °C ⁴⁾	4 h 10 min	4 h 10 min	4 h 10 min
Noise level	41.3 dBA	41.3 dBA	47.8 dBA
Heat output	438 W	442 W	492 W
Power supply	230 V, 50 Hz	230 V, 50 Hz	230 V, 50 Hz
Power consumption Eppendorf freezer ⁵⁾	10.5 kWh/day	10.6 kWh/day	11.8 kWh/day
Max. power consumption per 53 mm box ⁵⁾	18 Wh/day/20 Wh/day	18 Wh/day/20 Wh/day	21 Wh/day/22 Wh/day
Interior	Stainless steel	Stainless steel	Stainless steel
Password protection of setpoints	yes	yes	yes
Extras	Automatic vent port	Automatic vent port	Automatic vent port
Cooling liquid	R290 / R170	R290 / R170	R290 / R170
Remote Device Monitoring and Notifications (VisioNize®)	VisioNize-onboard	VisioNize-onboard	VisioNize-qualified

¹⁾ Optional CO₂/LN₂ backup systems add 8.65 cm/3.5 in to height. ²⁾ To allow for handles and hinges, add 80 mm to width of upright freezers and 110 mm to the depth of chest freezers. ³⁾ Door open adds up to 15 cm. ⁴⁾ Empty freezer with shelves fitted, upright freezers only, pull down from 20 – 22 °C ambient conditions. ⁵⁾ Empty freezer with shelves fitted, upright freezers only, set point -80 °C, 20 – 22 °C ambient conditions.



Model	CryoCube® F570h	CryoCube® F570hw	CryoCube® F570
Page(s)	272/278	272/278	272/278
Insulation	Vacuum insulation paneling / polyurethane foam	Vacuum insulation paneling / polyurethane foam	Polyurethane foam
Wall Thickness	Type C	Type C	Type A
Capacity	570 L	570 L	570 L
No. of internal doors	5		5
No. of compartments			
Max. racks per freezer	25	25	25
Box capacity per rack			
53 mm (2 in) tall boxes	16	16	16
76 mm (3 in) tall boxes	8	8	8
Box capacity per freezer			
53 mm (2 in) tall boxes	400	400	400
76 mm (3 in) tall boxes	200	200	200
Sample capacity			
53 mm (2 in) tall boxes	40,000	40,000	40,000
Dimensions (W x D x H)	102.5 x 85.2 x 194 cm	102.5 x 85.2 x 194.0 cm	102.5 x 85.2 x 194 cm
Dimensions internal (W x D x H)	76.5 x 57.5 x 126.5 cm	76.5 x 57.5 x 126.5 cm	76.5 x 57.5 x 126.5 cm
Weight w/o accessories	296 kg	296 kg	270 kg
Shipping weight	341 kg	341 kg	315 kg
Pull-down time to -80 °C ⁴⁾	3 h 30 min	3 h 45 min	4 h
Noise level	59.1 dBA	56.0 dBA	59.5 dBA
Heat output	316 W	325 W	438 W
Power supply	230 V, 50 Hz	230 V, 50 Hz	230 V, 50 Hz
Power consumption Eppendorf freezer ⁵⁾	7.6 kWh/day	7.8 kWh/day	10.5 kWh/day
Max. power consumption per 53 mm box ⁵⁾	19 Wh/day	19.5 Wh/day	26.3 Wh/day
Interior	Stainless steel	Stainless steel	Stainless steel
Password protection of setpoints	yes	yes	yes
Extras	Automatic vent port	Automatic vent port, water-cooled	Automatic vent port
Cooling liquid	R290 / R170	R290 / R170	R404A / R508B
Remote Device Monitoring and Notifications (VisioNize®)	VisioNize-qualified	VisioNize-qualified	VisioNize-qualified

Sample Handling



Model	Innova® U535	HEF® U410
Page(s)	272/278	272/278
Insulation	Vacuum insulation paneling / polyurethane foam	Vacuum insulation paneling / polyurethane foam
Wall Thickness	Type B	Type C
Capacity	535 L	410 L
No. of internal doors	3	5
No. of compartments	3	5
Max. racks per freezer	12	15
Box capacity per rack		
53 mm (2 in) tall boxes	28	16
76 mm (3 in) tall boxes	20	8
127 mm (5 in) tall boxes	12	
Box capacity per freezer		
53 mm (2 in) tall boxes	336	240
76 mm (3 in) tall boxes	240	120
102 mm (4 in) tall boxes	144	120
Sample capacity		
53 mm (2 in) tall boxes	33,600	24,000
Dimensions (W x D x H) ¹⁾²⁾³⁾	80 x 86.7 x 195 cm	80 x 85.2 x 193.0 cm
Dimensions internal (W x D x H)	64 x 61.5 x 136.5 cm	55 x 57.5 x 126.5 cm
Weight w/o accessories	250 kg	262 kg
Shipping weight	296 kg	307 kg
Pull-down time to -80 °C ⁴⁾	4 h	3 h 30 min
Noise level	56 dBA	53 dBA
Heat output	550 W	350 W
Power supply	230 V, 50 Hz	230 V, 50 Hz
Power consumption Eppendorf freezer ⁵⁾	13.2 kWh/day	8.4 kWh/day
Max. power consumption per 53 mm box ⁵⁾	39.3 Wh/day	35 Wh/day
Interior	Stainless steel	Stainless steel
Password protection of setpoints	yes	yes
Extras	-	-
Cooling liquid	R404A / R508B	R290 / R170
Remote Device Monitoring and Notifications (VisioNize®)	VisioNize-qualified	VisioNize-qualified

¹⁾ Optional CO₂/LN₂ backup systems add 8.65 cm/3.5 in to height. ²⁾ To allow for handles and hinges, add 80 mm to width of upright freezers and 110 mm to the depth of chest freezers. ³⁾ Door open adds up to 15 cm. ⁴⁾ Empty freezer with shelves fitted, upright freezers only, pull down from 20 – 22 °C ambient conditions. ⁵⁾ Empty freezer with shelves fitted, upright freezers only, set point -80 °C, 20 – 22 °C ambient conditions.



Model	Premium U410	Innova® U360	CryoCube® F101h
Page(s)	272/278	272/278	272/278
Insulation	Polyurethane foam	Vacuum insulation paneling / polyurethane foam	Vacuum insulation paneling / polyurethane foam
Wall Thickness	Type A	Type B	Type B
Capacity	410 L	360 L	101 L
No. of internal doors	5	3	2
No. of compartments	5	3	2
Max. racks per freezer	15	9	6
Box capacity per rack			
53 mm (2 in) tall boxes	16	28	10
76 mm (3 in) tall boxes	8	20	6
127 mm (5 in) tall boxes		12	4
Box capacity per freezer			
53 mm (2 in) tall boxes	240	252	60
76 mm (3 in) tall boxes	120	180	36
102 mm (4 in) tall boxes	120	108	24
Sample capacity			
53 mm (2 in) tall boxes	24,000	25,200	6,000
Dimensions (W x D x H)	80 x 85.2 x 193 cm	67 x 86.7 x 195 cm	90 x 56.6 x 83 cm
Dimensions internal (W x D x H)	55 x 57.5 x 126.5 cm	44 x 61.5 x 136.5 cm	48 x 33 x 64 cm
Weight w/o accessories	235 kg	230 kg	123 kg
Shipping weight	280 kg	266 kg	152 kg
Pull-down time to -80 °C	4 h 30 min	5 h 30 min	140 min
Noise level	55 dBA	56 dBA	55 dBA
Heat output	650 W	445 W	263 W
Power supply	230 V, 50 Hz	230 V, 50 Hz	230 V, 50 Hz
Power consumption Eppendorf freezer	10.8 kWh/day	10.7 kWh/day	6.3 kWh/day
Max. power consumption per 53 mm box	45 Wh/day	42.5 Wh/day	105 Wh/day
Interior	Stainless steel	Stainless steel	Stainless steel
Password protection of setpoints	yes	yes	yes
Extras	-	-	Stackable, fits below bench
Cooling liquid	R404A / R508B	R404A / R508B	R290 / R170
Remote Device Monitoring and Notifications (VisioNize®)	VisioNize-qualified	VisioNize-qualified	VisioNize-qualified

New

Sample Handling



Model	Innova® C760	CryoCube® FC660h
Page(s)	272/278	272/278
Insulation	Vacuum insulation paneling / polyurethane foam	Vacuum insulation paneling / polyurethane foam
Wall Thickness	Type B	Type C
Capacity	760 L	660 L
No. of internal doors		
No. of compartments	N/A	N/A
Max. racks per freezer	40	40
Box capacity per rack		
53 mm (2 in) tall boxes	14	13
76 mm (3 in) tall boxes	9	9
127 mm (5 in) tall boxes	5	5
Box capacity per freezer		
53 mm (2 in) tall boxes	560	520
76 mm (3 in) tall boxes	360	360
102 mm (4 in) tall boxes	280	280
Sample capacity		
53 mm (2 in) tall boxes	56,000	52,000
Dimensions (W x D x H) ¹⁾²⁾³⁾	205 x 82.5 x 109.2 cm	207 x 84 x 107.5 cm
Dimensions internal (W x D x H)	156 x 62.5 x 78 cm	147 x 59 x 76 cm
Weight w/o accessories	285 kg	304 kg
Shipping weight	358 kg	379 kg
Pull-down time to -80 °C ⁴⁾	3 h	2 h 50 min
Noise level	58 dBA	58.3 dBA
Heat output	667 W	338 W
Power supply	230 V, 50 Hz	230 V, 50 Hz
Power consumption Eppendorf freezer ⁵⁾	16 kWh/day	8.1 kWh/day
Max. power consumption per 53 mm box ⁵⁾	28 Wh/day	15.6 Wh/day
Interior	Stainless steel	Stainless steel
Password protection of setpoints	yes	yes
Extras	30 mm thick inner lids for temp uniformity	30 mm thick inner lids for temp uniformity
Cooling liquid	R404A / R508B	R290 / R170
Remote Device Monitoring and Notifications (VisioNize ⁶⁾)	VisioNize-qualified	VisioNize-qualified

¹⁾ Optional CO₂/LN₂ backup systems add 8.65 cm/3.5 in to height. ²⁾ To allow for handles and hinges, add 80 mm to width of upright freezers and 110 mm to the depth of chest freezers. ³⁾ Door open adds up to 15 cm. ⁴⁾ Empty freezer with shelves fitted, upright freezers only, pull down from 20 – 22 °C ambient conditions. ⁵⁾ Empty freezer with shelves fitted, upright freezers only, set point -80 °C, 20 – 22 °C ambient conditions.

Model	CryoCube® FC660	Innova® C585
Page(s)	272/278	272/278
Insulation	Polyurethane foam	Vacuum insulation paneling / polyurethane foam
Wall Thickness	Type A	Type B
Capacity	660 L	585 L
No. of internal doors		
No. of compartments	N/A	N/A
Max. racks per freezer	40	32
Box capacity per rack		
53 mm (2 in) tall boxes	13	14
76 mm (3 in) tall boxes	9	9
127 mm (5 in) tall boxes	5	5
Box capacity per freezer		
53 mm (2 in) tall boxes	520	448
76 mm (3 in) tall boxes	360	288
102 mm (4 in) tall boxes	280	224
Sample capacity		
53 mm (2 in) tall boxes	52,000	44,800
Dimensions (W x D x H) ¹⁾²⁾³⁾	207 x 84 x 107.5 cm	169 x 82.5 x 109.2 cm
Dimensions internal (W x D x H)	147 x 59 x 76 cm	120 x 62.5 x 78 cm
Weight w/o accessories	280 kg	240 kg
Shipping weight	328 kg	310 kg
Pull-down time to -80 °C ⁴⁾	3 h 15 min	4 h
Noise level	58.9 dBA	56 dBA
Heat output	440 W	567 W
Power supply	230 V, 50 Hz	230 V, 50 Hz
Power consumption Eppendorf freezer ⁵⁾	10.6 kWh/day	13.6 kWh/day
Max. power consumption per 53 mm box ⁵⁾	20.4 Wh/day	30.3 Wh/day
Interior	Stainless steel	Stainless steel
Password protection of setpoints	yes	yes
Extras	30 mm thick inner lids for temp uniformity	30 mm thick inner lids for temp uniformity
Cooling liquid	R404A / R508B	R404A / R508B
Remote Device Monitoring and Notifications (VisioNize ⁶⁾)	VisioNize-qualified	VisioNize-qualified

Eppendorf High-Efficiency ULT Upright Freezers

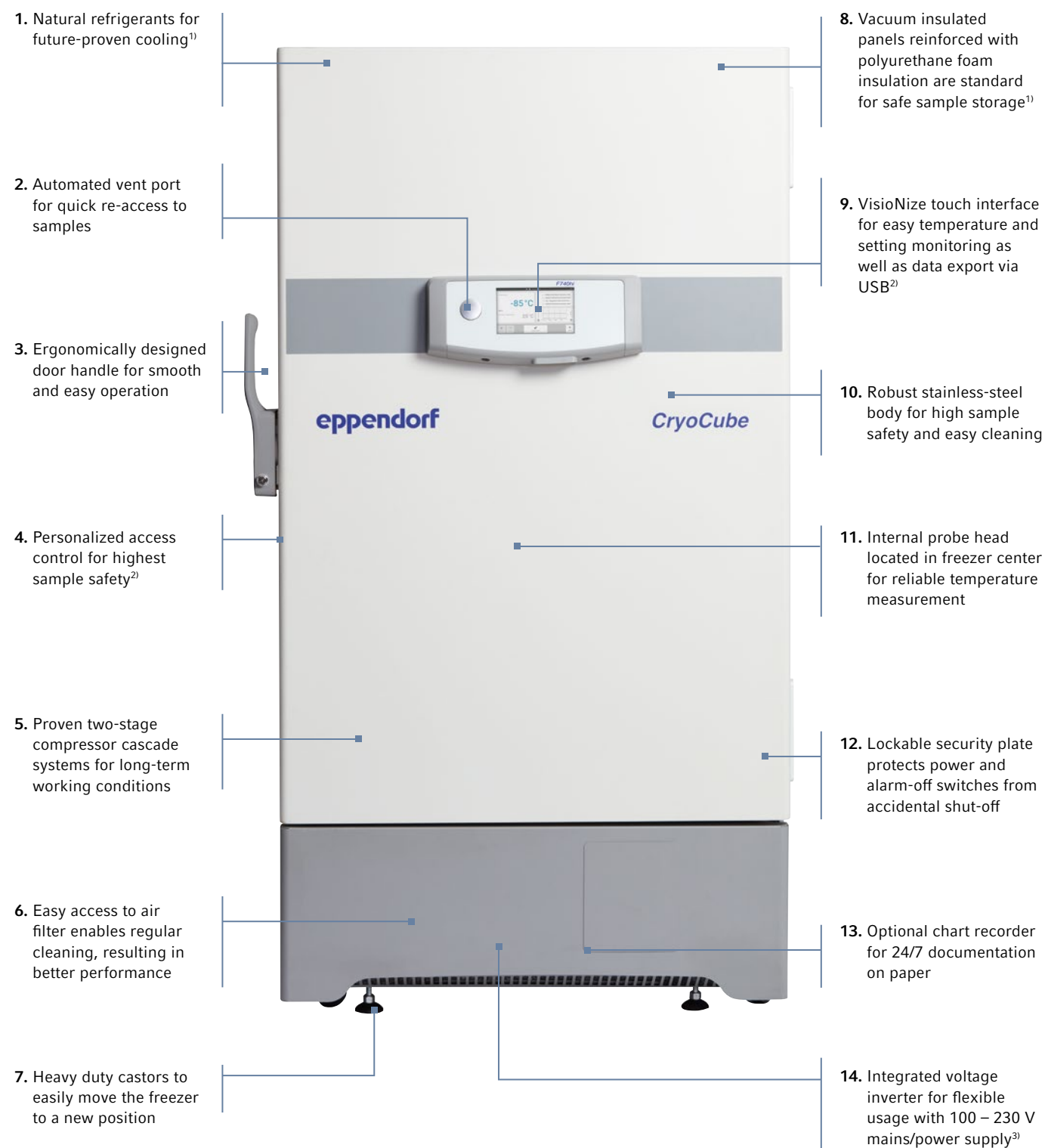

¹⁾ Selected models, ²⁾ „i” models of CryoCube F740 series, ³⁾ CryoCube F740 series



Complete Control

Worried about the safety of your high value samples within your ULT freezer? With the Eppendorf ULT monitoring concept available on CryoCube F740 ‘i’ series models, you can check the freezer performance whenever you want. All temperature data and all events are stored in the VisioNize touch interface.

The handling experience is based on our PhysioCare Concept® combined with extensive user test sessions.

- > On-board data storage means you are not dependent on auxiliary and secondary devices to keep track of freezer data
- > Easily transfer your information to your computer or colleague using the export feature and front-mounted USB port
- > Quickly and easily adjust your setpoints with a single finger, even while wearing gloves
- > Conveniently see all your important settings and data on a single screen with customizable views
- > Event tracking for controlled environments
- > Easily exchange data for documentation by USB
- > Electronic lock system for controlled access and higher sample safety

Adaptable alarm settings for individual needs

- > VisioNize-onboard devices: „i” versions
- > VisioNize box for other Eppendorf freezers

Find more information about the Eppendorf digital lab:
www.eppendorf.com/visionize



This icon tags VisioNize-onboard devices which can be conveniently connected to VisioNize for device monitoring and notifications customizable to meet your needs.

Further information are available at page 11.

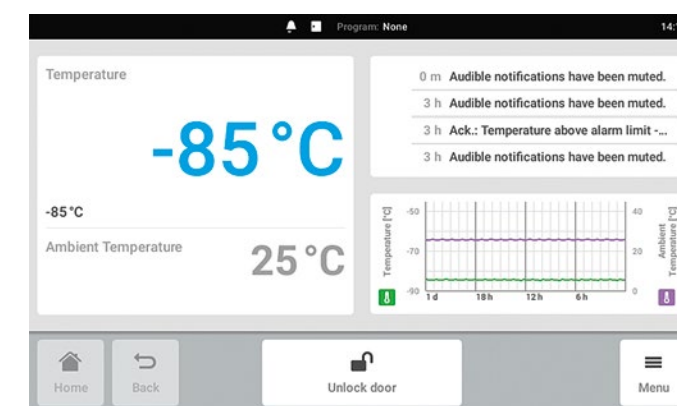

Easy Overview: Quickly review your important parameters on the home screen



- > **Ergonomic entry:** Comfortable door handle for easy opening (only CryoCubes)
- > **Controlled access:** Personalized access codes (CryoCubes F740«i» models), when necessary

For more information go to www.eppendorf.com

Eppendorf High-Efficiency ULT Upright Freezers



Confidence in Quality

Eppendorf has a long-standing history of innovation and quality, and our freezer manufacturer process is no exception. Each Eppendorf ULT freezer is thoroughly inspected to meet our rigorous quality guidelines. The final inspection takes more than 24h and is based on manual and visual checks. This process is documented by an individual certificate, completed with serial number, provided as standard for your documentation.

As your expert partner for reliable, high-quality, and efficient storage solutions, Eppendorf finely engineers each freezer with care, using only the highest quality materials to ensure a long lasting freezer that offers peace of mind and security. Eppendorf freezers are designed to offer a longterm value over the lifetime of its ownership. You can entrust your valuable samples to our ULT freezers, and you can trust your investment in all finely-engineered Eppendorf instruments.



Remember 2008?

As being one of the very first movers for green gases at -86 °C, Eppendorf has now more than 10 years of experience in R&D, production, logistics, and service in the field.



Environmentally friendly and energy efficient

Ultra-low temperature freezers traditionally consume a large amount of energy, as they maintain extremely low temperatures 24/7. With today's high energy costs and focus on the environment, energy conservation has become even more important in the lab. Eco-friendly Eppendorf ULT freezers are designed to help you save energy without compromising sample security.

- > A highly efficient compressor control system reduces cycling times to lower energy consumption and increase freezer longevity
- > Low noise levels and heat output to benefit your work environment
- > High-quality insulation materials and gaskets provide ultimate temperature control and optimized energy efficiency
- > Environmentally safe, HCFC-free and CFC-free refrigerants minimize greenhouse gases ("h" versions)
- > Biodegradable and commercially-available, high-performance, synthetic compressor lubricants prevent "oil-logging"
- > A single, quiet condenser fan reduces energy consumption; compared to many freezers that require two fans
- > Built with 95 – 98 % recyclable materials (by weight)
- > Meets WEEE directive
- > ENERGY STAR® partner

For more information go to www.eppendorf.com

Technical specifications subject to change.

Keep track of your samples with eLABInventory

eLABInventory is a sample management software provided by BioITech, an Eppendorf daughter company. The tool organizes any item in the laboratory inventory, including specimens, materials, samples, and chemicals. Store samples in self-configured storage units such as freezers or refrigerators. eLABInventory is flexible and fully configurable to work in your laboratory.

- > Fully configurable to fit any type of laboratory
- > Stores any type of samples, specimens, and materials for high flexibility
- > Works on any device, delivered via the cloud or on-premise
- > Intuitive user interface includes visual inventory browsing for easy handling
- > Barcode labeling and scanning for high-throughput
- > Import/export to other formats for data flexibility
- > Track and tracing for audit trail
- > GLP compliant sample management software
- > 21 CFR part 11 compliance for documentation security

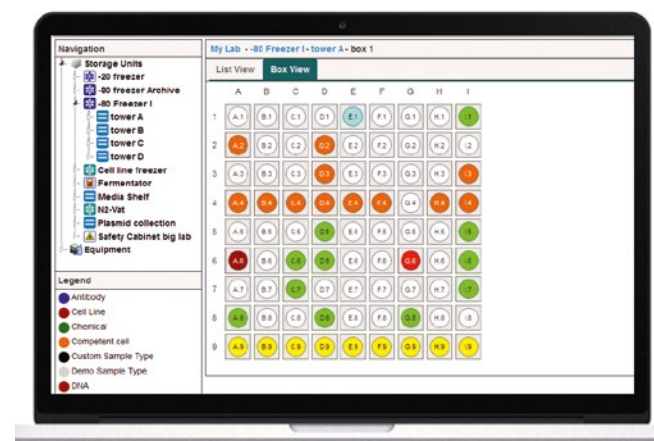

Start a free 30-day trial! Visit:
www.eLABInventory.com/eppendorf or
www.eLABJournal.com/eppendorf

Improve your efficiency when documenting research and tracking research data with eLABJournal®

The eLABJournal Electronic Lab Notebook, offers an intuitive and flexible solution to document research and track research data. It improves efficiency when documenting, organizing, searching and archiving collected data. With the free eLABJournal add-ons, you can extend the functionality of eLABJournal to a fully integrated Laboratory Information Management System.

Designed by scientists for scientists

- > Easily set up and apply workflows for lab routines using experiment templates
- > Use protocols as a template for your experiments and easily adjust the protocol according to your experiment setting using dynamic fields
- > Upload and link any type of file and link it to your experiment for safe documentation
- > eLABJournal has various add-ons to provide seamless integration and add great value to your account
- > To keep your data safe, we host our products in three data centers in different geographic locations that replicate and load-balance data in real time

For more information, visit www.eLABJournal.com

Please check www.eppendorf.com regarding the specific software licence models and related order numbers for eLABInventory and eLABJournal software.

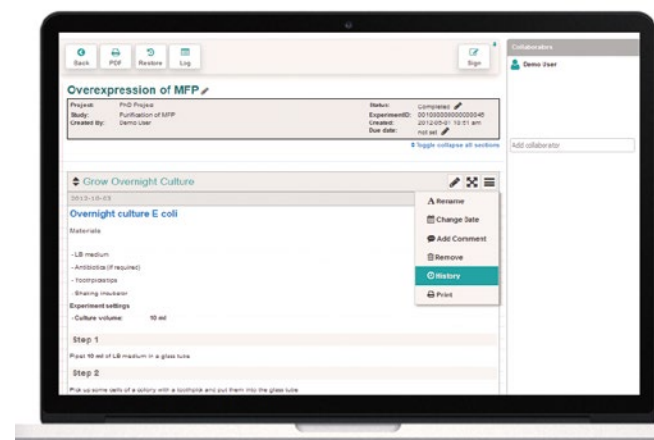

Your local distributor: www.eppendorf.com/contact

Eppendorf AG · Barkhausenweg 1 · 22339 Hamburg · Germany · eppendorf@eppendorf.com · www.eppendorf.com · www.eppendorf.com/eshop

Eppendorf ULT Freezers



Less force needed? New door handle design based on Eppendorf PhysioCare Concept® to enable easy access (limited to upright CryoCube freezers)



If you are in a hurry: Automatic vent port enables fast sample access (CryoCube F570 series and CryoCube F740 series only)



Keep it tight: Compact and flexible outer door seal for optimal insulation



External probes or back ups: Two access ports in the upper corner
Easy cleaning: Stainless steel inner chamber



Double safety: Gaskets at outer door as well as inner door (CryoCube F740 series + Innova® series)



Easy access to filter: Just flip down the cover of CryoCube F740 series
Silence: Filter position reduces noise level of CryoCube F740 series



Freedom to store: Stainless steel racks for freezer boxes of up to 136 x 136 mm footprint



You prefer privacy: The CryoCube F101h freezer – a real ULT in one small package below the bench



Comfortable storage: 30 mm thick inner lids, constructed from molded insulation, help maintain temperature stability



Easy cleaning: Inner doors can easily be removed for good access to compartments during cleaning of freezer



Decide what you need: 3-compartment/ shelves or 5-compartment/ shelves (CryoCube F740 series only)



Get the maximum in: 3-compartment set-up with MAX racks use every empty spot (CryoCube F740 series only)



VisioNize® box: The easy-to-install hardware hub connects your VisioNize-qualified devices to VisioNize. The hub works as a translation system enabling data collection of the device data in VisioNize. Gain access to the functions and features of VisioNize. Learn more on the page 11.

www.eppendorf.com/visionize

Ordering information

Description	Order no.
VisioNize® box, with mains/power adapter	1006 000 009
VisioNize® box cable, Ethernet, length 5 m	1006 073 006

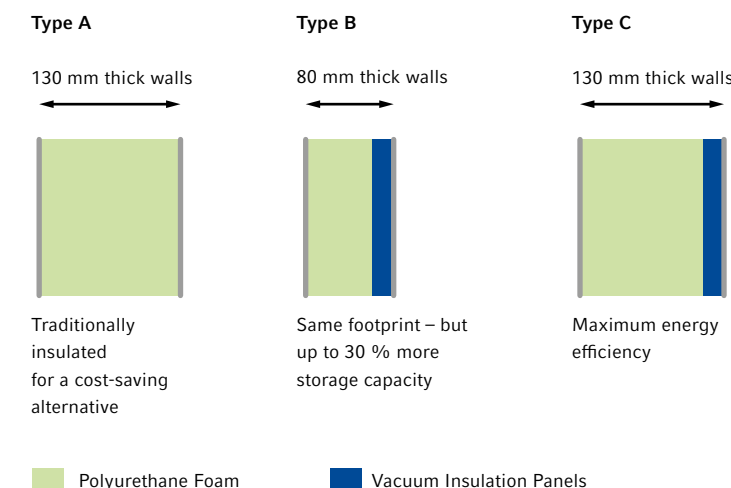

For more information go to www.eppendorf.com

Eppendorf ULT Upright Freezers

Ordering information		Order no.
Description		
CryoCube® F740h, 740 L, with LED interface, green cooling liquids, and air-cooling, handle left side, 3 shelves, 230 V/50 Hz		F740340011
CryoCube® F740h, 740 L, with LED interface, green cooling liquids, and air-cooling, handle right side, 3 shelves, 230 V/50 Hz		F740340021
CryoCube® F740h, 740 L, with LED interface, green cooling liquids, and air-cooling, handle left side, 5 shelves, 230 V/50 Hz		F740340031
CryoCube® F740h, 740 L, with LED interface, green cooling liquids, and air-cooling, handle right side, 5 shelves, 230 V/50 Hz		F740340041
CryoCube® F740hi, 740 L, with touchscreen interface, green cooling liquids, and air-cooling, handle left side, 3 shelves, 230 V/50 Hz		F740320011
CryoCube® F740hi, 740 L, with touchscreen interface, green cooling liquids, and air-cooling, handle right side, 3 shelves, 230 V/50 Hz		F740320021
CryoCube® F740hi, 740 L, with touchscreen interface, green cooling liquids, and air-cooling, handle left side, 5 shelves, 230 V/50 Hz		F740320031
CryoCube® F740hi, 740 L, with touchscreen interface, green cooling liquids, and air-cooling, handle right side, 5 shelves, 230 V/50 Hz		F740320041
CryoCube® F740hiw, 740 L, with touchscreen interface, green cooling liquids, and water-cooling, handle left side, 3 shelves, 230 V/50 Hz		F740320111
CryoCube® F740hiw, 740 L, with touchscreen interface, green cooling liquids, and water-cooling, handle left side, 5 shelves, 230 V/50 Hz		F740320131
CryoCube® F570, 570 L, with LED interface, classic cooling liquids, and air-cooling, handle left side, 5 shelves, 230 V/50 Hz		F570300001
CryoCube® F570h, 570 L, with LED interface, green cooling liquids, and air-cooling, handle left side, 5 shelves, 230 V/50 Hz		F570320001
CryoCube® F570hw, 570 L, with LED interface, green cooling liquids, and water-cooling, handle left side, 230 V/50 Hz		F570320101
Innova® U535, 535 L, with LED interface, classic cooling liquids, and air-cooling, 3 shelves, 230 V/50 Hz		U9430-0001
HEF® U410, 410 L, with LED interface, green cooling liquids, and air-cooling, 5 shelves, 230 V/50 Hz		U9260-0008
Premium U410, 410 L, with LED interface, classic cooling liquids, and air-cooling, 5 shelves, 230 V/50 Hz		U9260-0001
Innova® U360, 360 L, with LED interface, classic cooling liquids, and air-cooling, 3 shelves, 230 V/50 Hz		U9425-0001
CryoCube® F101h, 101 L, with LED interface, green cooling liquids, and air-cooling, handle left side, 2 shelves, 230 V/50 Hz		F101340001

✎ Ordering information for other voltage options begins on page 450

➤ For racks please check page 284

Eppendorf ULT Chest Freezers

Ordering information		Order no.
Description		
Innova® C760, 760 L, with LED interface, classic cooling liquids, and air-cooling, 230 V/50 Hz		U9410-0001
CryoCube® FC660, 660 L, with LED interface, classic cooling liquids, and air-cooling, 230 V/50 Hz		F660300001
CryoCube® FC660h, 660 L, with LED interface, green cooling liquids, and air-cooling, 230 V/50 Hz		F660320001
Innova® C585, 585 L, with LED interface, classic cooling liquids, and air-cooling, 230 V/50 Hz		U9400-0001

✎ Ordering information for other voltage options begins on page 450

➤ For racks please check page 284

Freezer Accessories



eLABInventory, eLABJournal® software

Please check www.eppendorf.com regarding the specific software licence models and related order numbers for eLABInventory and eLABJournal software.

Freezer Accessories



CO₂ and LN₂ Back-up System

- > Equipped with a battery back-up to temporarily protect the contents of your freezer in case of power failure
- > Available in either liquid CO₂ and LN₂. Liquid CO₂ can maintain temperatures between -50 °C and -70 °C, where as LN₂ can go down to -85 °C
- > Both systems can be factory installed with your freezer order or retrofitted on location
- > Info: CO₂ and LN₂ are not interchangeable systems

CO₂ and LN₂ Back-up System for Innova® U101, U360, U535, U725/ -G, C585, C760, CryoCube® F101h and F740 series

Description	Order no.
Eppendorf CO ₂ and LN ₂ Back-up System, 100 V/50/60 Hz	F652999005
CO ₂ back-up system, 120 – 220 V/60 Hz, Innova® and Green „G“, („narrow“)	U9043-0002
Innova® Green „G“ / F740, LN ₂ Backup, 100 V/50 – 60 Hz	F652999006
LN ₂ back-up system, 120 – 220 V/60 Hz, Innova® and Green „G“, („narrow“)	U9044-0002
CO ₂ back-up system, 230 V/50 Hz, Innova®, Green „G“, and CryoCube® 740 series, („narrow“)	U9043-0004
LN ₂ back-up system, 230 V/50 Hz, Innova®, Green „G“, and CryoCube® 740 series, („narrow“)	U9044-0004

CO₂ and LN₂ Back-up System for CryoCube® F570 series, FC660 series, Premium U410, HEF® U410

Description	Order no.
CO ₂ back-up system, 120 – 220 V/60 Hz, CryoCube® F570 series, CryoCube® FC660 series, Premium, and HEF®	U9043-0006
LN ₂ back-up system, 120 – 220 V/60 Hz, CryoCube® F570 series, CryoCube® FC660 series, Premium, and HEF®	U9044-0006
CO ₂ back-up system, 230 V/50 Hz, CryoCube® F570 series, CryoCube® FC660 series, Premium, and HEF®	U9043-0008
LN ₂ back-up system, 230 V/50 Hz, CryoCube® F570 series, CryoCube® FC660 series, Premium, and HEF®	U9044-0008



Chart Recorder

- > Type II: ULT freezer powered with backup battery (CryoCube F740 series)
- > Can be factory installed with your freezer order or retrofitted on location
- > Selectable temperature range (0 to -50 °C and -50 to -100 °C) and rotation speed
- > User configurable built in high and low temperature alarms

Ordering information

Description	Order no.
Chart Recorder (Type I)	P0625-2100
Chart Recorder (Type II) (100 – 120V), (CryoCube® F740 series)	F652999001
Chart Recorder (Type II) (208 – 230V), (CryoCube® F740 series)	F652999002
Chart Recorder pens (Type I), 3 pk	K0660-0051
Chart Recorder pens (Type II), 3 pcs.	F652999004
Chart Recorder paper, 0 to -50 °C	P0625-2111
Chart Recorder paper, -50 to -100 °C	P0625-2110
Chart Recorder paper, 0 to -100 °C, 60 pcs.	F652999003

Eppendorf SafeCode system

Safe sample identification needed?

»Stored vessels must be labeled« – naturally, every lab member agrees. In reality you always find some vessels in your freezer without any labeling or with non-readable labeling. Clear labeling is recommended to make reading as easy and as reliable as possible for everyone. Printed labels on vessels in plain writing are the minimum condition for safe reading. Barcodes or 2D datamatrix codes are one

step further towards a fast and safe sample identification. Pre-labeled vessels with up to a 3-level coding in different formats enable you to improve your processes. Smart labeling of your high-value samples is crucial for safe identification and ultimately for safe results. Manage your coded samples with sample management software like eLABInventory.

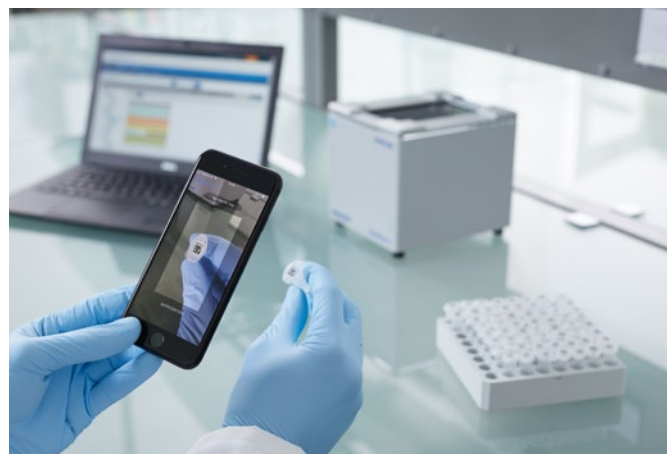

Eppendorf CryoStorage Vials

New



Scanning labels of 20 vials in a row?

The SafeCode system for Eppendorf CryoStorage Vials is based on a 3-level coding to enable safe sample identification. Up to 96 pre-labeled vials are pre-racked and pre-capped for convenient usage.

Features & benefits

- > Pre-racked for convenient handling
- > Pre-capped for easy handling and clean conditions
- > Easy and fast sample recognition for safe sample ID by 3-level coding:
 - > 1D barcode (side)
 - > Clear coding (side)
 - > 2D datamatrix code with ECC 200 error correction (bottom)
- > Further information like certificates etc. available (via Eppendorf homepage)
- > Automated data transfer to sample management software e.g. eLABInventory or external databases

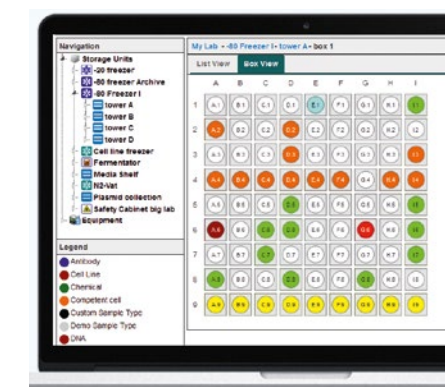

For more information go to www.eppendorf.com

Eppendorf CryoStorage Vials



Ordering information

Description	Order no.
Eppendorf CryoStorage Vial , 0.5 mL, free of DNase, RNase, human DNA, endotoxin; external thread, pre-capped gray, with 2D SafeCode (DataMatrix/ECC200), linear and human readable code, individually packed racks, 10 x 96 vials	0030 079 400
Eppendorf CryoStorage Vial , 1.0 mL, free of DNase, RNase, human DNA, endotoxin; external thread, pre-capped gray, with 2D SafeCode (DataMatrix/ECC200), linear and human readable code, individually packed racks, 10 x 96 vials	0030 079 418
Eppendorf CryoStorage Vial , 1.5 mL, free of DNase, RNase, human DNA, endotoxin; external thread, pre-capped gray, with 2D SafeCode (DataMatrix/ECC200), linear and human readable code, individually packed racks, 10 x 96 vials	0030 079 426
Eppendorf CryoStorage Vial , 2.0 mL, free of DNase, RNase, human DNA, endotoxin; external thread, pre-capped gray, with 2D SafeCode (DataMatrix/ECC200), linear and human readable code, individually packed racks, 10 x 96 vials	0030 079 434
Eppendorf CryoStorage Vial , 4.0 mL, free of DNase, RNase, human DNA, endotoxin; external thread, pre-capped gray, with 2D SafeCode (DataMatrix/ECC200), linear and human readable code, individually packed racks, 10 x 96 vials	0030 079 442
Eppendorf CryoStorage Vial, sterile , 0.5 mL, free of DNase, RNase, human DNA, endotoxin; external thread, pre-capped gray, with 2D SafeCode (DataMatrix/ECC200), linear and human readable code, individually packed racks, 10 x 96 vials	0030 079 450
Eppendorf CryoStorage Vial, sterile , 1.0 mL, free of DNase, RNase, human DNA, endotoxin; external thread, pre-capped gray, with 2D SafeCode (DataMatrix/ECC200), linear and human readable code, individually packed racks, 10 x 96 vials	0030 079 469
Eppendorf CryoStorage Vial, sterile , 1.5 mL, free of DNase, RNase, human DNA, endotoxin; external thread, pre-capped gray, with 2D SafeCode (DataMatrix/ECC200), linear and human readable code, individually packed racks, 10 x 96 vials	0030 079 477
Eppendorf CryoStorage Vial, sterile , 2.0 mL, free of DNase, RNase, human DNA, endotoxin; external thread, pre-capped gray, with 2D SafeCode (DataMatrix/ECC200), linear and human readable code, individually packed racks, 10 x 96 vials	0030 079 485
Eppendorf CryoStorage Vial, sterile , 4.0 mL, free of DNase, RNase, human DNA, endotoxin; external thread, pre-capped gray, with 2D SafeCode (DataMatrix/ECC200), linear and human readable code, individually packed racks, 10 x 96 vials	0030 079 493

Eppendorf RackScan

Scanning more than one sample in parallel?

The Eppendorf RackScan provides you different solutions to scan samples tubes with datamatrix (2D) codes. The Eppendorf RackScan b scans data from the bottom of the vessels. The instrument can be equipped with the „s“ accessory to read side-labeled barcodes. Data can be exported in different formats to downstream software applications.

New



Features & benefits

- > Easy and fast sample code recognition
- > Camera-based system for fast data reading
- > Automated data transfer to databases, e.g. eLABInventory software
- > Small footprint to save space
- > Robust design for long life time
- > Code scanner for side reading as accessory

Ordering information

Description	Order no.
Eppendorf RackScan s , code scanner for side reading of SBS racks and cryostorage boxes, accessory for the RackScan product family	6002 000 014
Eppendorf RackScan b , scanner (bottom reading) for 2D-coded tubes in SBS racks and cryostorage boxes, incl. software RackScan Analyzer	6002 000 006

Freezer Racks

Drawer or side access?

When using racks with drawers, only the drawer with the freezer boxes of interest is pulled out. All other boxes stay in the cold inner area of the ULT freezer. Eppendorf drawers are optimized for smooth movement at -80 °C for ergonomic handling. When using side access racks, most of the storage boxes have to be pulled out of the cold inner area of the ULT freezer to access the samples. Racks for chest freezers can be equipped with locking rods to secure freezer boxes when pulling out the rack tower.



Stainless steel or aluminum?

By standard, there are two types of rack materials available.

Stainless steel:

- > Stable/robust for longevity and higher capacity
- > For freezer boxes up to 136 mm x 136 mm for high flexibility regarding boxes
- > Special design for optimized cooling conditions and improved sample safety

Aluminum:

- > For freezer boxes up to 133 mm x 133 mm
- > Non-corrosive anodized aluminum for long-term use

Depth of racks

There are two systems used in laboratories - the standard 4-boxes deep racks and 5-boxes deep racks. Why is this of any interest? In case of an emergency, you want to rescue your valuable samples. The easiest way is to take out all racks (with the samples/ boxes included) and store those racks in some backup freezer. To be compatible with most common ULT freezer suppliers, Eppendorf ULT freezers are designed for 4-boxes deep racks.

3-compartment or 5-compartment?

The ULT freezer with 3 compartments/ shelves (e.g. Innova U535) has higher compartments compared to the 5-compartment ULT freezer (e.g. CryoCube F570 series). Racks of a 5-compartment freezer do fit into a 3-compartment freezer but not vice versa.

To get the maximum capacity out of your ULT freezer, the CryoCube F740 series (3-compartment) can be equipped with „3-compartment MAX“ racks. These racks only fit into the CryoCube F740 series 3-compartment instruments.



Rack without locking rod for Eppendorf chest freezer

Rack with locking rod for Eppendorf chest freezer

Rack for Eppendorf ULT freezer

Side access rack for Eppendorf ULT freezer

Stainless steel racks

Ordering information

Description	Order no.
Freezer Rack: Innova® U101, CryoCube® F101h	
2 in or 53 mm, drawer, stainless steel	6001 062 210
2.5 in or 64 mm, drawer, stainless steel	6001 062 910
3 in or 76 mm, drawer, stainless steel	6001 062 310
4 in or 102 mm, drawer, stainless steel	6001 062 410
5 in or 127 mm, drawer, stainless steel	6001 062 510
2 in or 53 mm, side access, stainless steel	6001 061 210
2.5 in or 64 mm, side access, stainless steel	6001 061 910
3 in or 76 mm, side access, stainless steel	6001 061 310
4 in or 102 mm, side access, stainless steel	6001 061 410
5 in or 127 mm, side access, stainless steel	6001 061 510
Freezer Rack: Innova® U360, U535, U725, U725-G, CryoCube® F740 series (3-compartment, Standard)	
2 in or 53 mm, drawer, stainless steel	6001 012 210
2.5 in or 64 mm, drawer, stainless steel	6001 012 910
3 in or 76 mm, drawer, stainless steel	6001 012 310
4 in or 102 mm, drawer, stainless steel	6001 012 410
5 in or 127 mm, drawer, stainless steel	6001 012 510
2 in or 53 mm, side access, stainless steel	6001 011 210
2.5 in or 64 mm, side access, stainless steel	6001 011 910
3 in or 76 mm, side access, stainless steel	6001 011 310
4 in or 102 mm, side access, stainless steel	6001 011 410
5 in or 127 mm, side access, stainless steel	6001 011 510
DWP (53 mm), side access, stainless steel	6001 011 110

For more information go to www.eppendorf.com

Freezer Racks

Please check the rack brochure for easy rack selection or use the rack configuration tool at <https://econfig.bio-itech.de>

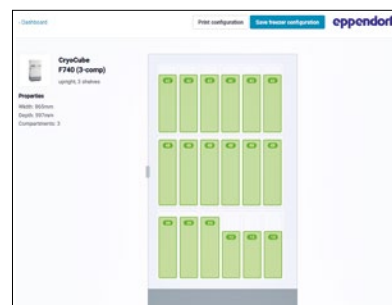

Ordering information

Description	Order no.
Freezer Rack: Premium U410, U700, HEF® U410, CryoCube® F570 series, CryoCube® F740 series (5-compartment, compartment 1-4)	
2 in or 53 mm, drawer, stainless steel	6001 022 210
2.5 in or 64 mm, drawer, stainless steel	6001 022 910
3 in or 76 mm, drawer, stainless steel	6001 022 310
4 in or 102 mm, drawer, stainless steel	6001 022 410
2 in or 53 mm, side access, stainless steel	6001 021 210
2.5 in or 64 mm, side access, stainless steel	6001 021 910
3 in or 76 mm, side access, stainless steel	6001 021 310
4 in or 102 mm, side access, stainless steel	6001 021 410
DWP (53 mm), side access, stainless steel	6001 021 110

Ordering information

Description	Order no.
Freezer Rack: CryoCube® F740 series (5-compartment, MAX for 5th comp.)	
2 in or 53 mm, side access, stainless steel	6001 081 210
2.5 in or 64 mm, side access, stainless steel	6001 081 910
3 in or 76 mm, side access, stainless steel	6001 081 310
4 in or 102 mm, side access, stainless steel	6001 081 410
5 in or 127 mm, side access, stainless steel	6001 081 510
DWP (53 mm), side access, stainless steel	6001 081 110
2 in or 53 mm, drawer, stainless steel	6001 082 210
2.5 in or 64 mm, drawer, stainless steel	6001 082 910
3 in or 76 mm, drawer, stainless steel	6001 082 310
4 in or 102 mm, drawer, stainless steel	6001 082 410
5 in or 127 mm, drawer, stainless steel	6001 082 510

Freezer Rack: CryoCube® F740 series (5-compartment, Standard compartment 1 – 4)

Ordering information

Description	Order no.
Freezer Rack: CryoCube® F740 series (3-compartment, MAX)	
2 in or 53 mm, side access, stainless steel	6001 071 210
2.5 in or 64 mm, side access, stainless steel	6001 071 910
3 in or 76 mm, side access, stainless steel	6001 071 310
4 in or 102 mm, side access, stainless steel	6001 071 410
5 in or 127 mm, side access, stainless steel	6001 071 510
DWP (53 mm), side access, stainless steel	6001 071 110
2 in or 53 mm, drawer, stainless steel	6001 072 210
2.5 in or 64 mm, drawer, stainless steel	6001 072 910
3 in or 76 mm, drawer, stainless steel	6001 072 310
4 in or 102 mm, drawer, stainless steel	6001 072 410
5 in or 127 mm, drawer, stainless steel	6001 072 510

Freezer Rack: CryoCube® F740 series (3-compartment, Standard)

➤ see page 285 at Innova table

Freezer Rack: Innova® C585, C760

Ordering information

Description	Order no.
2 in or 53 mm, side access, stainless steel	6001 040 210
2.5 in or 64 mm, side access, stainless steel	6001 000 910
3 in or 76 mm, side access, stainless steel	6001 000 310
4 in or 102 mm, side access, stainless steel	6001 000 410
5 in or 127 mm, side access, stainless steel	6001 000 510
DWP (53 mm), side access, stainless steel	6001 040 110
MTP, side access, stainless steel	6001 040 010
locking rod, 2 in or 53 mm, side access, stainless steel	6001 040 211
locking rod, 2.5 in or 64 mm, side access, stainless steel	6001 000 911
locking rod, 3 in or 76 mm, side access, stainless steel	6001 000 311
locking rod, 4 in or 102 mm, side access, stainless steel	6001 000 411
locking rod, DWP (53 mm), side access, stainless steel	6001 040 111
locking rod, MTP, side access, stainless steel	6001 040 011

Freezer Rack: CryoCube® FC660 series

Ordering information

Description	Order no.
2 in or 53 mm, side access, stainless steel	6001 050 210
2.5 in or 64 mm, side access, stainless steel	6001 000 910
3 in or 76 mm, side access, stainless steel	6001 000 310
4 in or 102 mm, side access, stainless steel	6001 000 410
5 in or 127 mm, side access, stainless steel	6001 000 510
DWP (53 mm), side access, stainless steel	6001 050 110
MTP, side access, stainless steel	6001 050 010
locking rod, 2 in or 53 mm, side access, stainless steel	6001 050 211
locking rod, 2.5 in or 64 mm, side access, stainless steel	6001 000 911
locking rod, 3 in or 76 mm, side access, stainless steel	6001 000 311
locking rod, 4 in or 102 mm, side access, stainless steel	6001 000 411
locking rod, DWP (53 mm), side access, stainless steel	6001 050 111
locking rod, MTP, side access, stainless steel	6001 050 011

Aluminum racks

Ordering information

Description	Order no.
Upright freezer rack: Innova® U101, CryoCube® F101h	
10 boxes per rack, 2 in or 53 mm, drawer, aluminum	K0641-3003
6 boxes per rack, 3 in or 76 mm, drawer, aluminum	K0641-3004
4 boxes per rack, 4 in or 102 mm, drawer, aluminum	K0641-3005
Chest freezer rack: Innova® C585, C760, CryoCube® FC660 series	
13 boxes per rack, 2 in or 53 mm, side access, aluminum	K0641-1690
9 boxes per rack, 3 in or 76 mm, side access, aluminum	K0641-1700
6 boxes per rack, 4 in or 102 mm, side access, aluminum	K0641-1750
Upright freezer rack: Innova® U360, U535, U725, U725-G, CryoCube® F740 series (3-compartment)	
28 boxes per rack, 2 in or 53 mm, drawer, aluminum	K0641-3000
20 boxes per rack, 3 in or 76 mm, drawer, aluminum	K0641-3001
12 boxes per rack, 4 in or 102 mm, drawer, aluminum	K0641-3002
Upright freezer rack: U410, HEF® U410, U700, CryoCube® F570 series, CryoCube® F740 series (5-compartment)	
16 boxes per rack, 2 in or 53 mm, drawer, aluminum	K0641-1900
12 boxes per rack, 3 in or 76 mm, drawer, aluminum	K0641-1890
8 boxes per rack, 4 in or 102 mm, drawer, aluminum	K0641-1880

Eppendorf Storage Boxes



In Need of Housekeeping?

The Eppendorf Storage Boxes are a complete system solution for sample storage. The comprehensive modular concept allows you to select the optimal box combinations for your individual storage demands. The outer footprint dimensions (133 mm) are compatible with common freezer rack systems. The different inner grids provide a perfect fit for all typical tube formats: cryogenic tubes, microcentrifuge tubes, conical tubes (5 mL, 25 mL, and 50 mL), and other laboratory vessels. This space-saving approach, together with the application benefits, helps to optimize your storage and archiving of samples.

1. Transparent lid for easy and fast sample inspection
2. 5 additional inscription labels on the lid enable user-specific labeling
3. Optimal use of freezer space through flexible combination of the different formats
4. Autoclavable (121 °C, 20 min) for sterilization
5. 15 and 50 mL conical tube boxes with ventilation slots for an evenly distributed freezing process. Prevent tube damage or breakage, which is frequently observed when freezing long tube formats in closed boxes

1. Laser-labeled, high-contrast, permanent alphanumeric markings of each location for easy sample reference and minimized risk of sample mix-up
2. Made of polypropylene (PP) for high stability in freezing applications and a smooth opening and closing
3. Dishwasher safe for easy cleaning

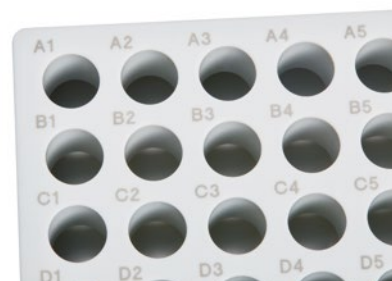

For more information go to www.eppendorf.com

Technical specifications subject to change.

Ordering information

Description	Order no.
Storage Box 10 × 10 , for 100 cryogenic tubes w. int. thread, 3 pcs., height 53 mm, 2 in, polypropylene, for freezing to -86 °C, autoclavable, with lid and alphanumeric code	0030 140 508
Storage Box 9 × 9 , for 81 screw cap (cryog.) tubes 1 – 2 mL, 3 pcs., height 53 mm, 2 in, polypropylene, for freezing to -86 °C, autoclavable, with lid and alphanumeric code	0030 140 516
Storage Box 9 × 9 , for 81 screw cap (cryog.) tubes 3 mL, 2 pcs., height 76 mm, 3 in, polypropylene, for freezing to -86 °C, autoclavable, with lid and alphanumeric code	0030 140 540
Storage Box 9 × 9 , for 81 screw cap (cryog.) tubes 4 – 5 mL, 2 pcs., height 102 mm, 4 in, polypropylene, for freezing to -86 °C, autoclavable, with lid and alphanumeric code	0030 140 567
Storage Box 8 × 8 , for 64 tubes 1 – 2 mL, 3 pcs., height 53 mm, 2 in, polypropylene, for freezing to -86 °C, autoclavable, with lid and alphanumeric code	0030 140 524
Storage Box 5 × 5 , for 25 tubes 5 mL, 4 pcs., height 64 mm, 2.5 in, polypropylene, for freezing to -86 °C, autoclavable, with lid and alphanumeric code	0030 140 532
Storage Box 5 × 5 , for 25 tubes 5 mL screw cap, 2 pcs., height 76 mm, 3 in, polypropylene, for freezing to -86 °C, autoclavable, with lid and alphanumeric code	0030 140 613
Storage Box 5 × 5 , for 25 tubes 15 mL, 2 pcs., height 127 mm, 5 in, polypropylene, for freezing to -86 °C, autoclavable, with lid and alphanumeric code	0030 140 583
Storage Box 3 × 3 , for 9 tubes 25 mL, 2 pcs., height 89 mm, 3.5 in, polypropylene, for freezing to -86 °C, autoclavable, with lid and alphanumeric code	0030 140 729
Storage Box 3 × 3 , for 9 tubes 50 mL and 4 tubes 15 mL, 2 pcs., height 127 mm, 5 in, polypropylene, for freezing to -86 °C, autoclavable, with lid and alphanumeric code	0030 140 591

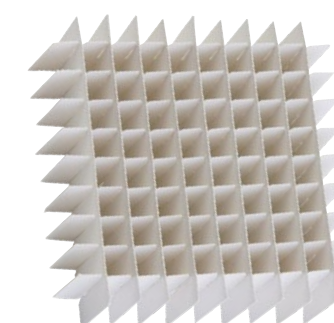
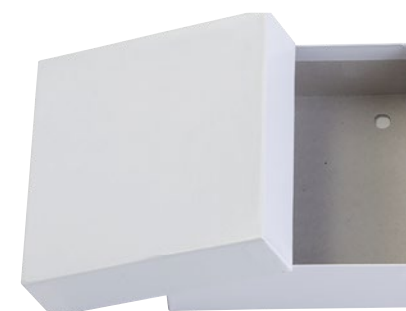

Freezer Cardboard Storage Boxes

- > White cardboard box with water resistant coating, designed to withstand ultra-low temperature
- > Available in 53 mm (2 in), 76 mm (3 in), and 102 mm (4 in) tall boxes
- > Compatible with box dividers 7 × 7 to 10 × 10 (dividers sold separately)
- > Dimensions: 133 mm x 133 mm

Freezer Boxes Dividers

- > Available in 7 × 7, 8 × 8, 9 × 9 and 10 × 10 configurations
- > Compatible with freezer cardboard storage boxes (sold separately)

Ordering information

Description	Order no.
Freezer Boxes Dividers	
7 × 7, 17.4 mm max. tube diameter, holds 49 tubes	D49
8 × 8, 15 mm max. tube diameter, holds 64 tubes	D64
9 × 9, 13 mm max. tube diameter, holds 81 tubes	D81
10 × 10, 11.8 mm max. tube diameter, holds 100 tubes	D100
Freezer Cardboard Storage Boxes, white	
53 mm tall	B50-SQ
76 mm tall	B75-SQ
102 mm tall	B95-SQ

Your local distributor: www.eppendorf.com/contact
Eppendorf AG · Barkhausenweg 1 · 22339 Hamburg · Germany · eppendorf@eppendorf.com · www.eppendorf.com · www.eppendorf.com/eshop

Eppendorf Eporator®

Description

The Eppendorf Eporator is a compact instrument designed for fast and controlled electroporation of bacteria, yeasts and other microorganisms. The instrument features an intuitive operation and user-friendly programming of standard methods. Experimental data can easily be exported and documented using its USB port.



Product features

- > Faster sample handling – simple one-button operation
- > Maximum safety via integrated cuvette holder
- > Compact, space-saving design
- > Self-explanatory operation guided by display indicators
- > Fast, freely programmable softkeys for saving and accessing the 2 most frequently used parameter settings
- > USB interface for data transfer and GLP supporting documentation

Applications

- > Transformation of bacteria, yeast or microorganisms with an optimal transformation efficiency of approx. 5 ms time constant
- > Mainly for delivery of plasmid DNA, but also RNA, proteins and other small molecules

Technical specifications

Technical specifications	Eporator
Model	Eporator
Interfaces	USB 2.0
Dimensions (W x D x H)	19 x 27.5 x 12.5 cm
Weight w/o accessories	3.2 kg
Capacitor	10 µF
Pulse form	Exponentially decreasing
Pulse voltage	200 – 2,500 V
Resistance	600 Ohm
Special features	Electronic protective circuit to prevent arcs
Time constant	Nominal 5 ms

Ordering information

Description	Order no.
Eppendorf Eporator®, for bacteria and yeasts, 230 V/50 – 60 Hz	4309 000 019
Eppendorf Cuvette Rack, 30 positions, for glass and plastic cuvettes, 2 pcs., polypropylene, numbered positions, autoclavable	0030 119 851

✎ Ordering information for other voltage options begins on page 450



On page 394 you will find detailed information on services for these products!

TransferMan® 4r

Description

The user-friendly TransferMan 4r possesses an ergonomic and innovative design to meet the most demanding micromanipulation requirements. Smart functions, such as improved automated home function and position storage, enable simple and fast execution of even the most complex micromanipulation techniques. The DualSpeed™ joystick allows for precise and intuitive movement in all three dimensions, and dynamic movement for covering longer distances. It is ideal for manipulation of oocytes and early embryos, transfer of stem cells and microparticles, and a wide range of applications in non human reproductive biology. Application-specific user profiles simplify the individual workflow process with four pre-defined application masks to choose from (e.g., for cell transfer, DNA injection, etc). The freely programmable „My app“ mask can be optimized according to individual needs. The TransferMan 4r is for research use only.



Applications

- > Micromanipulation of oocytes and early embryos
- > ES and iPS cell transfer
- > Nuclear transfer
- > Pronuclear and cytoplasmic injection (e.g., CRISPR/Cas, TALEN)
- > Selection of individual cells (e.g., biopsies, single cell picking)
- > Positioning and selection of microparticles
- > Microdissection of chromosomes, etc.
- > Microinjection into 3D organoids

Product features

- > Unique DualSpeed™ joystick for precise and instantaneous movement control
- > Maximum stability ensures vibration-free work
- > One Joystick for all 3 axes (X, Y, Z) movements and in axial direction (X/Z)
- > Angle adjustment from 0° to 90°
- > One-hand operation for capillary and angle settings
- > Programmable Z-axis limit for preventing capillary breakage
- > Connection with Eppendorf PiezoXpert® and electronic microinjectors FemtoJet® 4i/4x
- > Can be adapted to all conventional microscopes
- > PC interface for remote control



www.eppendorf.com/TransferMan4r

Ordering information

Description	Order no.
TransferMan® 4r, micromanipulator with DualSpeed™ joystick for direct and dynamic movement control, 100 – 240 V/50 – 60 Hz	5193 000 012

✎ Ordering information for other voltage options begins on page 450

InjectMan® 4

Description

The InjectMan 4 is ideal for microinjection into adherent cells, smaller organisms and embryos in the early stages of development. In combination with the FemtoJet 4i or 4x, it enables fast semi-automatic injection. Furthermore, the InjectMan 4 is the ideal micromanipulator for all complex applications that require a dynamic movement mode and direct control of the injection process via the joystick button. The axial injection movement (X/Z direction) helps to minimize mechanical stress to the adherent cells upon injection. The high penetration speed makes injection into rigid structures easier than ever. The new user interface with four pre-defined application masks facilitates the individual workflow process (e.g., for adherent cell injection, serial microinjection into fish larvae, etc.). The freely programmable „My app“ mask can be optimized for individual needs. Due to its exceptional precision and position stability, the InjectMan 4 is also suited for applications such as patch clamp. The motor modules can be uncoupled electronically to prevent accidental movement of the micropipette. The InjectMan 4 is for research use only.

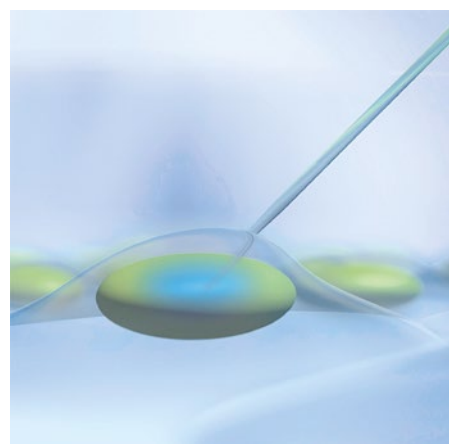

Electronic coupling with the FemtoJet - for fast, serial (>20 cells/min) and minimally invasive (axial direction) injections

Applications

- > Semi-automatic microinjection into adherent cells
- > Serial microinjection into fish larvae, frog eggs, insect embryos, etc.
- > Injection into living plant cells, *C. elegans* and other roundworms and flatworms
- > Automatic dispensing of cell suspensions or solutions
- > Stable, drift-free positioning, e.g. for electrophysiology techniques

Product features

- > Maximum stability ensures drift-free work
- > Electronic coupling to FemtoJet microinjectors for fast serial semi-automatic injections with highest reproducibility
- > Selection and programming of advanced functions (e.g. axial movement, step injection)
- > Ergonomically shaped control panel for fatigue-free work
- > Easy and precise angle adjustment
- > Connection with Eppendorf PiezoXpert for piezo-assisted penetration over a pre-defined distance
- > Can be adapted to all conventional microscopes
- > PC interface for remote control

Ordering information

Description	Order no.
InjectMan® 4, micromanipulator with dynamic movement control, 100 – 240 V/50 – 60 Hz	5192 000 019

✂ Ordering information for other voltage options begins on page 450

i For more information go to www.eppendorf.com

Technical specifications subject to change.

Technical specifications		
Model	InjectMan 4	TransferMan 4r
Motor module set		
Max. traveling distance	≥20 mm in X, Y, Z and X/Z direction	≥20 mm in X, Y, Z and X/Z direction
Weight (complete)	2.15 kg	2.15 kg
Stepper motor	X-, Y-, Z-module	X-, Y-, Z-module
Single module (X, Y, Z)		
Step size	<20 nm (computational resolution)	<20 nm (computational resolution)
Speed	0 – 10,000 µm/s	0 – 10,000 µm/s
Mechanical adjustability	>80 mm	>80 mm
Dimensions	129 x 51 x 36 mm	129 x 51 x 36 mm
Weight	570 g	570 g
Swivel joint		
Direction of rotation	-45° to +90°	-45° to +90°
Capillary exchange	Direction of rotation: forward	Direction of rotation: forward
Sample replacement	Direction of rotation: backward	Direction of rotation: backward
Angle head		
Operating angle	0° – 90°	0° – 90°
Control board		
Control	Joystick (dynamic kinetics)	Joystick (proportional and dynamic kinetics)
Speed modes	coarse, fine, x-fine	coarse, fine, x-fine
External Device/PC	Serial interface SUBD9, male	Serial interface SUBD9, male
Dimensions (W x H x D)	205 x 288 x 152 mm	205 x 288 x 152 mm
Weight	1.8 kg	1.8 kg

Accessories

Description	Order no.
Positioning aid , pack of 2, for mounting and re-positioning universal capillary holder and the capillary holder 4 on TransferMan® 4r and InjectMan® 4	5192 072 001
Spare parts kit	5192 071 005
Headstage holder	5192 073 008
Foot control for triggering injection with FemtoJet® 4i and FemtoJet® 4x	5252 070 020
Connection cable , for connecting TransferMan® 4r/InjectMan® 4 to FemtoJet® 4i/4x	5192 082 007
Connection cable , for connecting Eppendorf micromanipulators with FemtoJet® and FemtoJet® express	5181 070 015
Connection cable , for connecting Eppendorf micromanipulators with PC or Eppendorf PiezoXpert®	5181 150 094
Y-cable FJ4 , Y-cable for connecting FemtoJet® 4i/4x with a PC and TransferMan® 4r or InjectMan® 4	5192 080 004
Y-cable PX , Y-cable for connecting Eppendorf PiezoXpert® or a PC with TransferMan® 4r or InjectMan® 4 and FemtoJet® 4i/4x	5192 081 000



www.eppendorf.com/InjectMan4



See our capillary portfolio on page 303

Microscope Adapters for Micromanipulation Systems

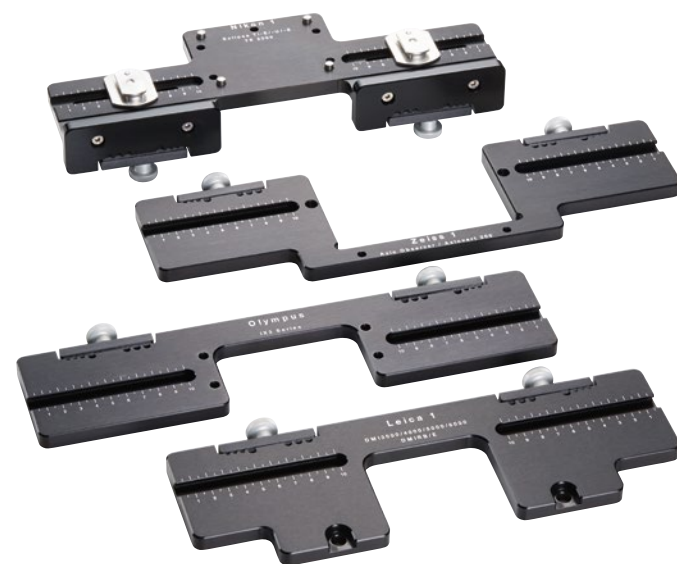

Microscope adapters

Eppendorf microscope adapters enable the simple installation of the TransferMan® 4r or InjectMan® 4 on all conventional inverted microscopes manufactured by Leica®, Nikon®, Olympus® and Zeiss®



Compatible to the four major microscope brands



Universal stand

The Universal stand can be used for mounting the TransferMan 4 and InjectMan 4 micromanipulators on upright microscopes and stereo microscopes independent of the microscope tripod used. With its magnetic foot the Universal stand can be firmly fixed to any ferromagnetic base (plate or table).

Find all available adapters here



www.eppendorf.com/microscope_adapter

Ordering information

Description	Order no.
Adapter Leica® 1 , for Eppendorf micromanipulation systems, for Leica® DMi8, DM13000 B, 3000 M, 4000 B, 5000 B, 5000 M, 6000 B, DM IRB E, HC and DM IRE 2 microscopes	5192 301 000
Adapter Leica® 2 , for Eppendorf micromanipulation systems, for Leica® DM IL LED and HC microscopes	5192 302 007
Adapter Nikon® 1 , for Eppendorf micromanipulation systems, for Nikon® Eclipse® Diaphot 200, 300 and Eclipse® Ti-E, Ti-U, Ti-S, TE200, TE300, TE2000 microscopes	5192 316 008
Adapter Nikon® 2 , for Eppendorf micromanipulation systems, for Nikon® Eclipse® Ts2R microscope	5192 317 004
Adapter Nikon® 3 , for Eppendorf micromanipulation systems, for Nikon® Eclipse Ti2-E/-A/-U microscopes	5192 318 000
Adapter Olympus® 1 , for Eppendorf micromanipulation systems, for Olympus® IX50, IX51, IX70, IX71, IX80 and IX81 microscopes	5192 306 002
Adapter Olympus® 2 , for Eppendorf micromanipulation systems, for microscopes of Olympus® IX3 series with illumination column IX3-ILL	5192 307 009
Adapter Olympus® 3 , for Eppendorf micromanipulation systems, for microscopes of Olympus® IX3 series with illumination column IX2-ILL30	5192 308 005
Adapter Zeiss® 1 , for Eppendorf micromanipulation systems, for Zeiss® Axiovert® 200, Axio Observer A1, D1, Z1 and Axio Observer 3, 5 and 7 microscopes	5192 311 006
Adapter Zeiss® 2 , for Eppendorf micromanipulation systems, for Zeiss® Axio Vert.A1 microscope	5192 312 002
Universal stand , for mounting Eppendorf micromanipulators on upright microscopes and stereo microscopes independent of the microscope tripod used	5192 325 007
Adapter bridge , for mounting Eppendorf micromanipulators on microscope adapters for TransferMan® NK 2, InjectMan® NI 2 and PatchMan NP 2	5192 321 001

Technical specifications subject to change.

Antivibration Pad

Description

The antivibration pads are specifically designed to effectively protect your micromanipulation system against external vibrations. The pads are simply positioned directly under the base points of your microscope. Five different formats optimized for specific weight ranges are available to guarantee optimal results. A selection of pads specifically chosen for each microscope ensures effective protection for your sample.

Product features

- > Effectively protects micromanipulation workstations from external vibrations
- > Five different formats available
- > Different formats can be combined for optimal adjustment



Ordering information

Description	Order no.
Antivibration Pad XS , weight range 4.5 – 6.0 kg	5181 301 009
Antivibration Pad S , weight range 6.0 – 8.0 kg	5181 303 001
Antivibration Pad M , weight range 8.0 – 10.0 kg	5181 305 004
Antivibration Pad L , weight range 10.0 – 12.5 kg	5181 307 007
Antivibration Pad XL , weight range 12.5 – 16.5 kg	5181 309 000

It is decisive to take into account the total weight of your microscope, including the mounted accessories, and the load distribution of the individual contact points.

Your local distributor: www.eppendorf.com/contact

Eppendorf AG · Barkhausenweg 1 · 22339 Hamburg · Germany · eppendorf@eppendorf.com · www.eppendorf.com · www.eppendorf.com/eshop

Eppendorf PiezoXpert®

Description

The Eppendorf PiezoXpert allows for piezo-assisted micromanipulation, enabling simple penetration of cells for microinjection or micromanipulation. Perforation of the cell membrane is supported by piezo impulses which are directly transferred to the capillary without any loss of intensity. Piezo-assisted micromanipulation improves the results of a variety of applications including transfer of embryonic or induced pluripotent stem cells into blastocysts and morulae, injection into mammalian oocytes and zygotes, and enucleation/nuclear transfer. The Eppendorf PiezoXpert forms the perfect system with Eppendorf micromanipulators, but it integrates just as easily into non-Eppendorf micromanipulation systems. The Eppendorf PiezoXpert is for research use only.



Product features

- > Fast and simple sample processing due to intuitive operation
- > Reproducible parameter setting
- > Program keys to save your experimental parameters
- > Trigger impulses with an ergonomic foot control or rotary knobs right on the device
- > Optical feedback of triggered impulses
- > Additional „Clean“ function for simple removal of contamination on the outside of the capillary

Applications

- > Piezo-ICSI (Intracytoplasmic Sperm Injection) in mouse, equine, porcine etc.
- > Transfer of embryonic or induced pluripotent stem cells into blastocysts or morulae
- > Enucleation/nuclear transfer
- > Blastomere biopsy from mouse embryos
- > Biopsy of equine embryos for Preimplantation Genetic Diagnosis
- > RNA/DNA injection into fertilized oocytes of mammals

For more information go to www.eppendorf.com

Technical specifications	
Model	PiezoXpert
Interfaces	USB (for technical service), RS-232 (connection to foot control)
Power supply	100 – 240 V, 50 – 60 Hz
Max. power consumption	18 W
Dimensions (W x D x H)	17 x 23 x 11.5 cm
Weight w/o accessories	2.8 kg
Piezo impulse	
Intensity (of piezo impulses)	1 – 86 (1 – 22 adjustable in increments of 1, 22 – 86 adjustable in increments of 4)
Number (number of piezo impulses)	1 – 10, ∞ (1 – 10 adjustable in increments of 1)
Speed (frequency of piezo impulses/sec)	1 – 40 (1 – 40 adjustable in increments of 1, 1 – 10: 1 Hz per increment, 10 – 20: 2 Hz per increment, 20 – 34: 5 Hz per increment, 34 – 40: 25 Hz per increment)
Clean function	
Intensity (of piezo impulses)	1 – 86 (1 – 22 adjustable in increments of 1, 22 – 86 adjustable in increments of 4)
Speed (frequency of piezo impulses/sec)	1 – 40 (1 – 40 adjustable in increments of 1, 1 – 10: 1 Hz per increment, 10 – 20: 2 Hz per increment, 20 – 34: 5 Hz per increment, 34 – 40: 25 Hz per increment)

Ordering information

Description	Order no.
Eppendorf PiezoXpert®, for piezo-assisted micromanipulation, incl. actuator 2, foot control and spacer plate and grip head 4 size 0, 100 – 240 V/50 – 60 Hz	5194 000 016
Actuator 2, for piezo-assisted micromanipulation, as accessory for the Eppendorf PiezoXpert	5194 075 156
Grip head set 4 size 0, for microcapillaries with outer diameter 1.0 to 1.1 mm	5196 082 001
Grip head set 4 size 1, for microcapillaries with outer diameter 1.2 to 1.3 mm	5196 083 008
Grip head set 4 size 2, for microcapillaries with outer diameter 1.4 to 1.5 mm	5196 084 004
Grip head set 4 size 3, for microcapillaries with outer diameter 0.7 to 0.9 mm	5196 085 000
Tube adapter, pack of 2, for connecting tubes with an outer diameter of 2 mm or 3 mm with the capillary holder and the capillary holder 4	5194 075 407
Piezo Drill Tip ICSI, for piezo-assisted mouse ICSI (for research use only), 25° tip angle, 6 µm inner diameter, 6 mm flange, sterile, set of 25	5195 000 087
Piezo Drill Tip ES, for piezo-assisted mouse ES cell transfer (for research use only), 25° tip angle, 15 µm inner diameter, 6 mm flange, sterile, set of 25	5195 000 095

Ordering information for other voltage options begins on page 450

CellTram[®] 4r Air/Oil

Description

The CellTram 4r Air and CellTram 4r Oil are manual microinjectors suitable for a broad range of life science applications. The CellTram 4r Air is a pneumatic injector for oil-free micromanipulation and gentle holding of cells in suspension. Due to its excellent performance, it is also highly suitable for uptake and injection of cells (e.g., of sperm or ES cells). For this application, its performance is comparable to that of oil-filled injectors. The CellTram 4r Oil is a hydraulic, oil-filled microinjector that provides more direct sample control and can generate higher pressures than an air system. It is optimized for leakage-free work and easy oil filling. Both models can be used with all common micromanipulation systems yet they develop their full potential with Eppendorf manipulators. The CellTram 4r Air/Oil injectors are for research use only.



1. Non-hydraulic system for oil-free manipulation and injection of cells (CellTram 4r Air)

2. Piston position scale enables setting of air volume and injection characteristics according to individual needs (CellTram 4r Air)

3. Improved oil-filling system for quick and clean re-filling (CellTram 4r Oil)

4. Coarse and fine drive for precise and intuitive sample control

5. Improved rotary knob design for better handling and easier cleaning

6. Capillary holder 4 with markings for easier positioning

7. New grip head 4 system for simple capillary change and higher user safety

8. Position indicators and marking for in/out to reduce risk of user errors

9. Stable, nonslip base plate

10. Highly reliable performance with minimal maintenance

i For more information go to www.eppendorf.com

Technical specifications subject to change.



CellTram 4r Air: Pressure responsiveness for various applications can be adjusted by different piston positions

CellTram 4r Oil: The new oil-filling system helps avoid oil-spilling and facilitates the filling process

Applications

- > ICSI of mouse and large mammals (e.g., equine, porcine...)
- > Piezo-assisted micromanipulation in combination with the Eppendorf PiezoXpert[®]
- > Transfer of cells or organelles (e.g., ES cell or iPS cell transfer into blastocysts or morulae)
- > Enucleation/nuclear transfer
- > (Xeno)transplantations
- > Removal of cells (e.g., for polar body biopsy, blastomere biopsy or trophectoderm biopsy)
- > Manual microinjection and dispensing of aqueous solutions
- > Single cell picking

Technical specifications		
Model	CellTram 4r Air	CellTram 4r Oil
Cylinder volume	10 mL	1,000 μ L
Max. pressure	3,000 hPa	20,000 hPa
Min. adjustable volume	< 100 nL	< 1.5 nL
Pressure generation	Cylinder/piston system, air-filled	Cylinder/piston system, oil-filled
Volume change per revolution	60 μ L/600 μ L (fine/ coarse rotary knob)	1 μ L/10 μ L (fine/ coarse rotary knob)

Ordering information

Description	Order no.
CellTram [®] 4r Air, manual pneumatic microinjector, with gears 1:1 and 1:10, for holding and injection	5196 000 013
CellTram [®] 4r Oil, manual hydraulic microinjector, with gears 1:1 and 1:10, for holding and injection	5196 000 030
Capillary holder 4, for mounting microcapillaries	5196 081 005
Capillary holder 4 slim shape, for flat angle injections, for microcapillaries with outer diameter 1.0 mm	5196 062 000
Filling and Cleaning set, incl. filling tube, Luer lock adapter, 2 syringes for CellTram [®] 4	5196 088 000
Grip head set 4 size 0, for microcapillaries with outer diameter 1.0 to 1.1 mm (1 only)	5196 082 001
Grip head set 4 size 1, for microcapillaries with outer diameter 1.2 to 1.3 mm (1 only)	5196 083 008
Grip head set 4 size 2, for microcapillaries with outer diameter 1.4 to 1.5 mm (1 only)	5196 084 004
Grip head set 4 size 3, for microcapillaries with outer diameter 0.7 to 0.9 mm (1 only)	5196 085 000
Injection tube Air, white ring mark, I.D. 0.5 mm, length 1.3 m	5196 061 004
Injection tube Oil, blue ring mark, I.D. 1.0 mm, length 1.3 m	5196 089 006
O-ring set 4, incl. 10 o-rings large, 10 o-rings small, 2 distance sleeves, o-ring removal tool for grip head set 4	5196 086 007

Your local distributor: www.eppendorf.com/contact

Eppendorf AG · Barkhausenweg 1 · 22339 Hamburg · Germany · eppendorf@eppendorf.com · www.eppendorf.com · www.eppendorf.com/eshop

FemtoJet® 4i and FemtoJet® 4x

Description

Eppendorf's electronic microinjectors FemtoJet 4i and FemtoJet 4x with their simple operation menu and a range of functionalities are perfectly suited for injecting small to intermediate volumes. With a built-in compressor, the FemtoJet 4i is the tool of choice for injecting aqueous solutions into adherent cells and suspension cells. If your research demands injecting volumes greater than 100 pL and/or longer series at higher pressures, FemtoJet 4x with its external pressure supply (not included) delivers the precise and continuous pressure required. Featuring the same quality design and compatibility features as the FemtoJet 4i, the FemtoJet 4x is the „heavy duty“ device for those more demanding applications. Both the FemtoJet 4i and FemtoJet 4x, form the perfect system with Eppendorf micromanipulators, yet they integrate just as easily with non-Eppendorf micromanipulation systems. The electronic connection between FemtoJet 4i or 4x and TransferMan 4r or InjectMan 4 guarantees simple, rapid and reproducible microinjections into cells, simplifying your daily work and speeding up your workflow. The FemtoJet 4i/ 4x injectors are for research use only.



Product features

- > Very simple and clearly arranged operation for routine tasks
- > Injection volume ranges from femtoliters to microliters
- > Inject and Clean function can be triggered right on the device using the included mouse or optional foot control
- > Programmable injection guarantees high reproducibility
- > Connection to TransferMan 4r, InjectMan 4 or InjectMan NI 2 enables semi-automatic microinjection
- > Small footprint
- > Can be combined with all conventional micromanipulation systems
- > Independent pressure supply via built-in compressor (only FemtoJet 4i)
- > External pressure supply guarantees the continuous availability of higher injection pressures – even with large volumes and very short intervals (only FemtoJet 4x)

Gentle treatment for your cells



Minimizing mechanical trauma to your sample is critical for achieving optimal results. The new capillary holder 4 (slim shape) in combination with Eppendorf manipulators allows for injecting with straight capillaries at angles lower than 15°. This capillary holder 4 (slim shape) can be used in combination with the FemtoJet 4 as well as with the CellTram 4r. This helps to achieve highest survival rates for your developing embryos.



For more information go to www.eppendorf.com

Technical specifications subject to change.

FemtoJet® 4i



Description

The electronic microinjector, FemtoJet 4i, with its simple operation and wide range of functionality is ideally suited for injecting small to intermediate volumes (of up to 100 pL) into adherent cells and suspension cells for research purposes. The FemtoJet 4i with its built-in compressor forms a perfect team with Eppendorf micromanipulators, but it integrates just as easily with non-Eppendorf micromanipulator systems.

The electronic connection between FemtoJet 4i and TransferMan 4r and InjectMan 4 guarantees simple, rapid and reproducible microinjections into cells.

Applications

- > Reproducible and serial microinjection into adherent cells when combined with the InjectMan 4 or InjectMan NI 2 micromanipulator
- > Pronuclear or cytoplasmic injection of RNA/DNA solutions into fertilized oocytes of mammals, when combined with the TransferMan 4r micromanipulator
- > Especially well suited for injection volumes from femtoliters to 100 pL

FemtoJet® 4x



Description

The FemtoJet 4x is the ideal solution if your research demands injection volumes greater than 100 pL and/or longer series at higher pressures – increasingly seen in functional genomics and developmental biology applications.

The FemtoJet 4x with its external pressure supply (not included) delivers the precise and continuous pressure required. Featuring the same quality design and compatibility as the FemtoJet 4i, the 4x model is the „heavy duty“ device for those more volume demanding applications.

Applications

- > Microinjection into small organisms and embryos in the early stages of development (e.g., *Drosophila melanogaster*, Zebrafish, etc.)
- > Especially well suited for serial injection volumes from 100 pL to 1 µL or more

Typical Injection Volume	FemtoJet 4i → FemtoJet 4x			
Cell nucleus of adherent cells				
Cytoplasm of adherent cells				
Pronucleus of fertilized mouse oocytes				
<i>Caenorhabditis elegans</i>				
Fish embryos in early development phases				
<i>Xenopus laevis</i> oocytes				
Volume (liter, logarithm, measurement unit)	10 ⁻¹⁵	10 ⁻¹²	10 ⁻⁹	10 ⁻⁶
Unit	femtoliter	picoliter	nanoliter	microliter

FemtoJet 4i is suitable for applications that require lower volume ranges; FemtoJet 4x is better suited for applications that require higher volume ranges. Both feature the same injection time and pressure parameters.

Your local distributor: www.eppendorf.com/contact

Eppendorf AG · Barkhausenweg 1 · 22339 Hamburg · Germany · eppendorf@eppendorf.com · www.eppendorf.com · www.eppendorf.com/eshop

FemtoJet® 4i and FemtoJet® 4x



Both the FemtoJet 4i and FemtoJet 4x, can easily be combined for all types of micromanipulators, yet they form the perfect system with Eppendorf micromanipulators.

Technical specifications		
Model	FemtoJet 4i	FemtoJet 4x
Dimensions (W x D x H)	21.3 x 20.7 x 25 cm	21.3 x 20.7 x 25 cm
Weight w/o accessories	5 kg	3.5 kg
Clean function	Max. 6,000 hPa (87 psi)	Max. 6,000 hPa (87 psi)
Compensation pressure	5 – 6,000 hPa (87 psi); can be set in increments of 1 hPa	5 – 6,000 hPa (87 psi); can be set in increments of 1 hPa
Injection pressure	5 – 6,000 hPa (87 psi); can be set in increments of 1 hPa	5 – 6,000 hPa (87 psi); can be set in increments of 1 hPa
Injection time interval	0.10 s – 99.99 s	0.10 s – 99.99 s
Pressure supply	Integrated compressor	External pressure supply (not included)

Ordering information

Description	Order no.
FemtoJet® 4i, programmable microinjector with integrated pressure supply, including foot control	5252 000 013
FemtoJet® 4x, programmable microinjector with external pressure supply (not included), including foot control	5253 000 017
Capillary holder 4, for mounting microcapillaries	5196 081 005
Capillary holder 4 slim shape, for flat angle injections, for microcapillaries with outer diameter 1.0 mm	5196 062 000
Injection tube, for universal capillary holder and capillary holder 4, 2 m	5252 070 054
O-ring set 4, incl. 10 o-rings large, 10 o-rings small, 2 distance sleeves, o-ring removal tool for grip head set 4	5196 086 007
Grip head set 4 size 0, for microcapillaries with outer diameter 1.0 to 1.1 mm (1 only)	5196 082 001
Grip head set 4 size 1, for microcapillaries with outer diameter 1.2 to 1.3 mm (1 only)	5196 083 008
Grip head set 4 size 2, for microcapillaries with outer diameter 1.4 to 1.5 mm (1 only)	5196 084 004
Grip head set 4 size 3, for microcapillaries with outer diameter 0.7 to 0.9 mm (1 only)	5196 085 000
Grip head set 4 (slim shape), for Capillary holder 4 slim shape incl. 6 O-rings and 2 distance sleeves, for capillaries with outer diameter 1.0 mm	5196 063 007
Hand control, for triggering inject function	5252 070 011
Y-cable FJ4, Y-cable for connecting FemtoJet® 4i/4x with a PC and TransferMan® 4r or InjectMan® 4	5192 080 004
Y-cable PX, Y-cable for connecting Eppendorf PiezoXpert® or a PC with TransferMan® 4r or InjectMan® 4 and FemtoJet® 4i/4x	5192 081 000

✂ Ordering information for other voltage options begins on page 450

Cell Transfer Capillaries

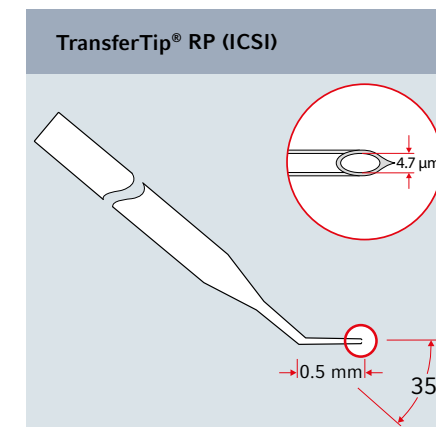

Applications

- > Sperm transfer into oocytes

Description

- > 4.7 µm inner diameter
- > 35° tip angle
- > 0.5 mm flange length
- > Fine tapered and rigid tip flange for optimal cell penetration
- > Heat-formed spike eases penetration
- > Sterilized via validated gamma irradiation
- > Non-cytotoxic (as proven by mouse embryo assay)
- > Capillary safe for optimum protection

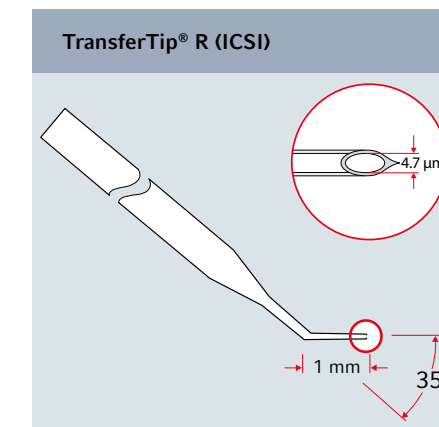

Applications

- > Sperm transfer into oocytes

Description

- > 4.7 µm inner diameter
- > 35° tip angle
- > 1 mm flange length
- > Rigid tip flange for successful penetration
- > Heat-formed spike eases penetration
- > Sterilized via validated gamma irradiation
- > Non-cytotoxic (as proven by mouse embryo assay)
- > Capillary safe for optimum protection

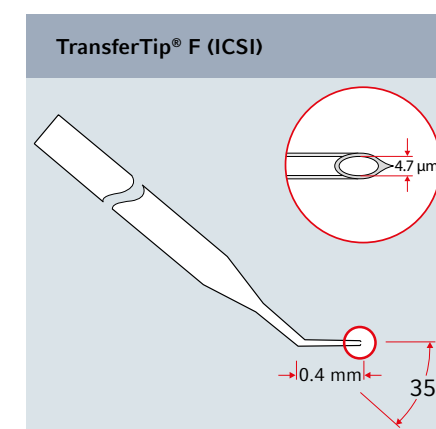

Applications

- > Sperm transfer into oocytes

Description

- > 4.7 µm inner diameter
- > 35° tip angle
- > 0.4 mm flange length
- > Fine tapered and flexible tip flange for minimal cell trauma
- > Heat-formed spike eases penetration
- > Sterilized via validated gamma irradiation
- > Non-cytotoxic (as proven by mouse embryo assay)
- > Capillary safe for optimum protection

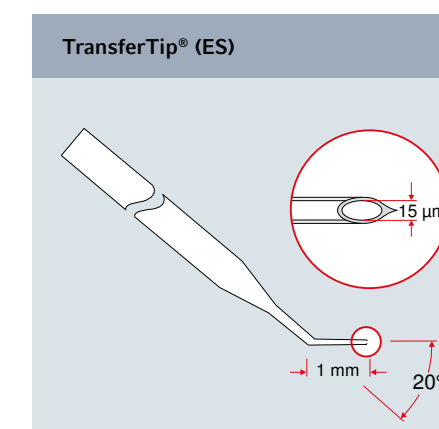

Applications

- > Transfer of ES cells into mouse blastocyst or morula

Description

- > 15 µm inner diameter
- > 20° tip angle
- > Rigid flange, 1 mm length
- > Heat-formed spike eases penetration
- > Sterilized via validated gamma irradiation
- > Capillary safe for optimum protection

Holding Capillaries

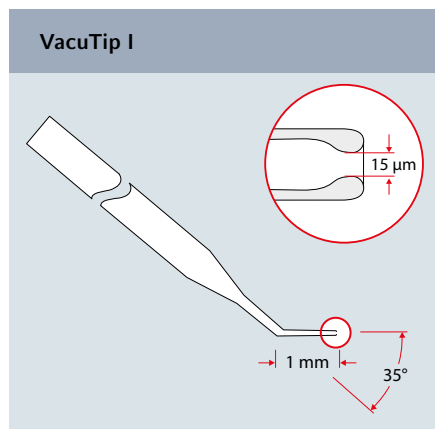

Applications

- > For holding oocytes, blastocysts, etc.

Description

- > 15 μm inner diameter
- > 100 μm outer diameter
- > 35° tip angle
- > Flange length 1 mm
- > Smooth, rounded tip end for gentle holding
- > Sterilized via validated gamma irradiation
- > Non-cytotoxic (as proven by mouse embryo assay)
- > Capillary safe for optimum protection

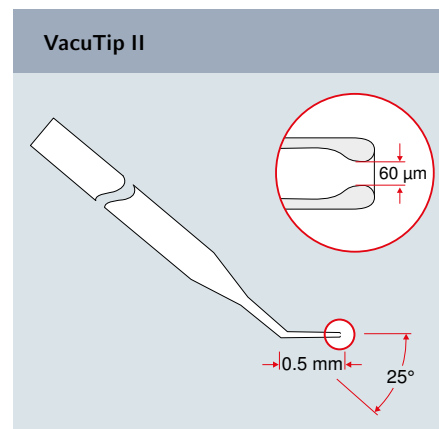

Applications

- > For holding oocytes, blastocysts, etc.

Description

- > 60 μm inner diameter
- > 110 μm outer diameter
- > 25° tip angle
- > Flange length 0.5 mm
- > Smooth rounded tip end for gentle holding
- > Sterilized via validated gamma irradiation
- > Non-cytotoxic (as proven by mouse embryo assay)
- > Capillary safe for optimum protection

Biopsy Tips

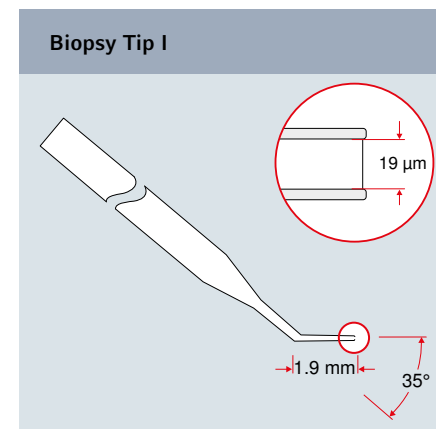

Applications

- > Laser-assisted biopsy of cells and organelles

Description

- > 19 μm inner diameter
- > 35° tip angle
- > 1.9 mm flange length
- > Rounded tip end to minimize oolemma trauma
- > Sterilized via validated gamma radiation
- > Non-cytotoxic (as proven by mouse embryo assay)
- > Capillary safe for optimum protection

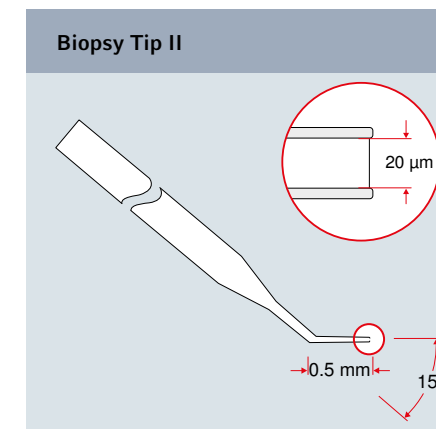

Applications

- > Laser-assisted biopsy of cells and organelles

Description

- > 20 μm inner diameter
- > 15° tip angle
- > 0.5 mm flange length
- > Rounded tip end to minimize oolemma trauma
- > Sterilized via validated gamma irradiation
- > Non-cytotoxic (as proven by mouse embryo assay)
- > Capillary safe for optimum protection

Capillaries for Piezo-assisted Cell Transfer

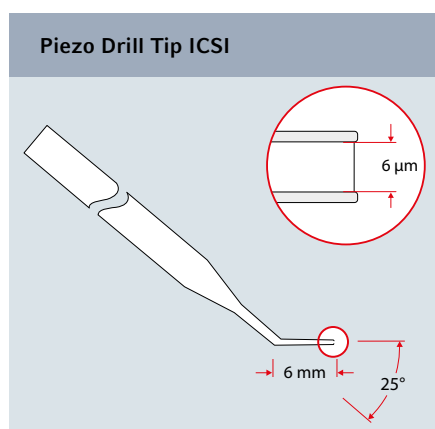

Applications

- > Piezo-assisted transfer of sperms into mammalian oocytes

Description

- > 6 μm inner diameter
- > 25° tip angle for optimal pulse transfer
- > 6 mm flange length
- > Non-polished, blunt tip end for optimal piezo pulse force transfer and minimal trauma
- > Sterilized via validated gamma irradiation
- > Capillary safe for optimum protection

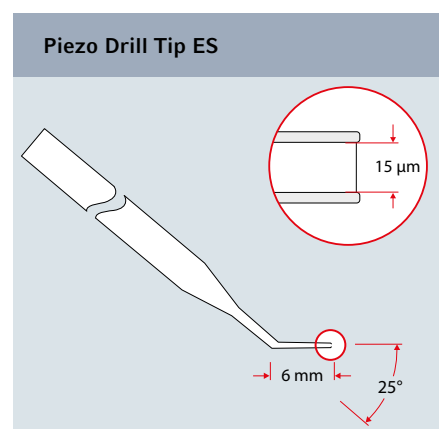

Applications

- > Piezo-assisted transfer of embryonic stem cells into blastocysts

Description

- > 15 μm inner diameter
- > 25° tip angle for optimal pulse transfer
- > 6 mm flange length
- > Non-polished, blunt tip end for optimal piezo pulse force transfer and minimal trauma
- > Sterilized via validated gamma irradiation
- > Capillary safe for optimum protection

Microinjection Capillaries

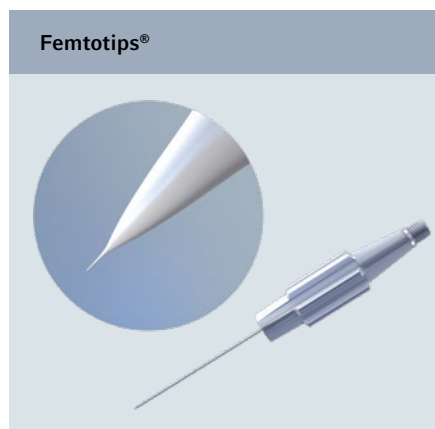

Applications

- > Injection into adherent cells
- > Near-surface injection into oocytes, early stage embryos and smaller organisms

Description

- > 0.5 µm inner diameter
- > Screw-in thread for quick assembly into FemtoJet capillary holder
- > Sterile
- > 100 % individual testing of every Femtotip using a flow parameter
- > Safe transport packaging

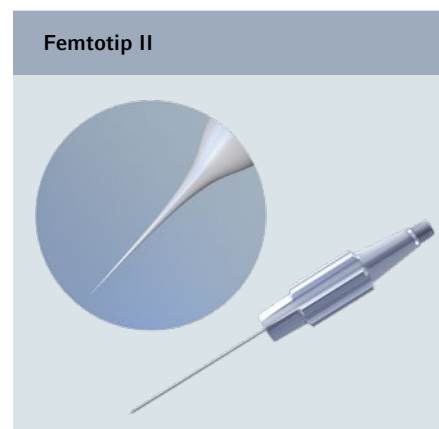

Applications

- > Injection into adherent cells
- > Deep injection into mammalian oocytes, early stage embryos (e.g. Zebrafish) and smaller organisms

Description

- > 0.5 µm inner diameter
- > Screw-in thread for quick assembly into FemtoJet capillary holder
- > Sterile
- > 100 % individual testing of every Femtotip using a flow parameter
- > Safe transport packaging

Microloader™

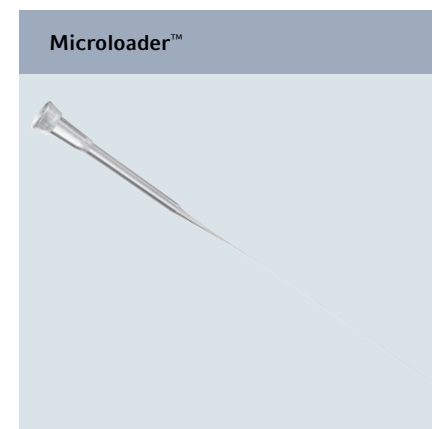

Applications

- > Pipette tip for back-filling of Femtotips and other microcapillaries

Description

- > Extremely long, fine and flexible tip for filling of microcapillaries for microinjection and where additional reach is needed
- > Microloader tips and rack autoclavable
- > Highest precision and accuracy when used with Eppendorf pipettes for 0.5 to 10 µL (gray control button)



Learn more:

[eppendorf.com/microcapillaries](https://www.eppendorf.com/microcapillaries)

Ordering information

Description	Order no.
Microloader™ , tip for filling Femtotips and other glass microcapillaries (for research use only), 0.5 – 20 µL, 100 mm, light gray, 192 pcs. (2 racks x 96 pcs.)	5242 956 003
Femtotips® , injection capillary (for research use only), sterile, set of 20	5242 952 008
Femtotip II , injection capillary (for research use only), sterile, set of 20	5242 957 000
VacuTip I , holding capillary (for research use only), 35° tip angle, 15 µm inner diameter, 100 µm outer diameter, 1 mm flange, sterile, set of 25	5195 000 036
VacuTip II , holding capillary (for research use only), 25° tip angle, 60 µm inner diameter, 110 µm outer diameter, 0.5 mm flange, sterile, set of 25	5195 000 044
TransferTip® RP (ICSI) , for sperm injection using the ICSI technique (for research use only), 35° tip angle, 4 µm inner diameter, 0.5 mm flange, sterile, set of 25	5195 000 010
TransferTip® F (ICSI) , for sperm injection using the ICSI technique (for research use only), 35° tip angle, 4 µm inner diameter, 0.4 mm flange, sterile, set of 25	5195 000 001
TransferTip® R (ICSI) , for sperm injection using the ICSI technique (for research use only), 35° tip angle, 4 µm inner diameter, 1 mm flange, sterile, set of 25	5195 000 028
Biopsy Tip I , capillary for laser-assisted biopsy of cells and organelles (for research use only), 35° tip angle, 19 µm inner diameter, 1.9 mm flange, sterile, set of 25	5195 000 052
Biopsy Tip II , capillary for laser-assisted biopsy of cells and organelles (for research use only), 15° tip angle, 20 µm inner diameter, 0.5 mm flange, sterile, set of 25	5195 000 060
TransferTip® (ES) , for ES cell transfer (for research use only), 20° tip angle, 15 µm inner diameter, 1 mm flange, sterile, set of 25	5195 000 079
Piezo Drill Tip ICSI , for piezo-assisted mouse ICSI (for research use only), 25° tip angle, 6 µm inner diameter, 6 mm flange, sterile, set of 25	5195 000 087
Piezo Drill Tip ES , for piezo-assisted mouse ES cell transfer (for research use only), 25° tip angle, 15 µm inner diameter, 6 mm flange, sterile, set of 25	5195 000 095

Workstations for Microinjection and Micromanipulation



Workstation for cell transfer and injection and related techniques

Recommended setup:

- > 2 × TransferMan® 4r
- > 1 × Microscope adapter (to be specified at time of order)
- > 1 × CellTram® 4r Air
- > 1 × CellTram® 4r Oil
- > 1 × set of 25 TransferTip® microcapillaries (to be specified at time of order)
- > 1 × set of antivibration pads (number and format depending on setup)

Optional for piezo-assisted micromanipulation:

- > 1 × Eppendorf PiezoXpert®
- > 1 × set of 25 Piezo Drill Tips (to be specified at time of order)

Workstation for pronuclear and cytoplasmic injection of nucleic acid solutions

Recommended setup:

- > 2 × TransferMan® 4r
- > 1 × Microscope adapter (to be specified at time of order)
- > 1 × CellTram® 4r Air
- > 1 × FemtoJet® 4i or FemtoJet® 4x
- > 1 × set of 20 Femtotip II
- > 2 × racks of 96 Microloader
- > 1 × set of antivibration pads (number and format depending on setup)

Optional for piezo-assisted micromanipulation:

- > 1 × Eppendorf PiezoXpert®
- > If necessary: 1 × Y cable PX



Workstation for injection into adherent cells, plant cells, *Drosophila*, *C.elegans*, etc.

Recommended setup:

- > 1 × InjectMan® 4
- > 1 × Microscope adapter (to be specified at time of order)
- > 1 × FemtoJet® 4i or FemtoJet® 4x
- > 1 × set of 20 Femtotips® (to be specified at time of order)
- > 2 × racks of 96 Microloader
- > 1 × set of antivibration pads (number and format depending on setup)

Optional for adherent cell injection:

- > 1 × Eppendorf Cell Imaging Dishes

Workstation for injection into fish embryos

Recommended setup:

- > 1 × InjectMan 4
- > 1 × Universal stand
- > 1 × FemtoJet® 4x
- > 1 × set of 20 Femtotips® (to be specified at time of order)
- > 2 × racks of 96 Microloader

Optional for piezo-assisted injection:

- > 1 × Eppendorf PiezoXpert®



Workstations for Microinjection and Micromanipulation



Workstation for cell transfer and injection and related techniques

Recommended setup:

- > 2 × TransferMan® 4r
- > 1 × Microscope adapter (to be specified at time of order)
- > 1 × CellTram® 4r Air
- > 1 × CellTram® 4r Oil
- > 1 × set of 25 TransferTip® microcapillaries (to be specified at time of order)
- > 1 × set of antivibration pads (number and format depending on setup)

Optional for piezo-assisted micromanipulation:

- > 1 × Eppendorf PiezoXpert®
- > 1 × set of 25 Piezo Drill Tips (to be specified at time of order)

Workstation for pronuclear and cytoplasmic injection of nucleic acid solutions

Recommended setup:

- > 2 × TransferMan® 4r
- > 1 × Microscope adapter (to be specified at time of order)
- > 1 × CellTram® 4r Air
- > 1 × FemtoJet® 4i or FemtoJet® 4x
- > 1 × set of 20 Femtotip II
- > 2 × racks of 96 Microloader
- > 1 × set of antivibration pads (number and format depending on setup)

Optional for piezo-assisted micromanipulation:

- > 1 × Eppendorf PiezoXpert®
- > If necessary: 1 × Y cable PX



Workstation for injection into adherent cells, plant cells, *Drosophila*, *C.elegans*, etc.

Recommended setup:

- > 1 × InjectMan® 4
- > 1 × Microscope adapter (to be specified at time of order)
- > 1 × FemtoJet® 4i or FemtoJet® 4x
- > 1 × set of 20 Femtotips® (to be specified at time of order)
- > 2 × racks of 96 Microloader
- > 1 × set of antivibration pads (number and format depending on setup)

Optional for adherent cell injection:

- > 1 × Eppendorf Cell Imaging Dishes

Workstation for injection into fish embryos

Recommended setup:

- > 1 × InjectMan 4
- > 1 × Universal stand
- > 1 × FemtoJet® 4x
- > 1 × set of 20 Femtotips® (to be specified at time of order)
- > 2 × racks of 96 Microloader

Optional for piezo-assisted injection:

- > 1 × Eppendorf PiezoXpert®



Eppendorf Cell Culture Consumables

Description

How much impact does seemingly simple plastic have on your cell culture results?

Together with the medium nothing comes closer to your cells, especially for a long duration. Therefore, the chemical composition including all additives and the absence of certain factors is crucial. In addition to smart solutions for contamination prevention, simplified handling and improved optical performance, Eppendorf cell culture consumables offer a transparent and certified insight into material quality. For improved reproducibility with minimized interference of your cell culture results. Improve now.



Applications

- > Expansion and culture of adherent and suspension cells on TC treated or on non-treated polystyrene
- > Performance of cell-based assays and microscopic analysis



www.eppendorf.com/cc

All non-coated Cell Culture Consumables	
Surface	Tissue culture treated or non-treated (TC-treatment test for cell attachment and cell growth: passed)
Sterility/Purity	All products are sterile: Production in controlled class 8 clean room environment based on ISO 14644-1. Sterility is assured by irradiation according to DIN EN ISO 11137-2015 with sterility assurance level (SAL) of 10 ⁻⁶ . Sterility is tested according to USP, Ph. Eur. 2.6.1. Test for absence of pyrogens, RNase/DNase and DNA: passed
Material	Polystyrene. The raw material used complies with USP Class VI standards
Certificates	
Trace metal release	Al, Pb, Cd, Ca, Cr, Cu, Mg, Mn, Ni, Hg, Zn (measured with inductively coupled plasma – mass spectrometry after 72 h at 40 °C incubation)
Leachables	> Material suppliers of Eppendorf do not use or intentionally incorporate the following agents into the materials for the production: > Slip agents (including oleamide, erucamide, stearamides), Biocides (including di(2-hydroxyethyl) methyl dodecyl ammonium salts (DiHEMDA)), Plasticizers (including phthalates), Bisphenol A, Latex, Antistatic agents, Metallic dyes, Mineral oil
Download certificates	www.eppendorf.com > Cell Culture Consumables > Certificates
Cytotoxicity testing	Tested in a cell-based assay for in-vitro cytotoxicity according to ISO 10993-5 by an external partner
Production conditions	Quality management system is certified according to ISO 9001, 13485 and 14001

Eppendorf Cell Culture Plates

Description

Keep your cells warm outside the incubator, avoid the edge effect and use more wells.

Eppendorf Cell Culture Plates are designed for expansion of smaller cell numbers and for cell-based assays.

The chimney-well design avoids inhomogeneous growth of cells in the outer ring of wells which reduces costs and increases efficiency. If cells need to spend more time outside of the incubator, filling the inter-well spaces of the plate will keep the temperature stable and prevent unwanted temperature shifts. We optimized the optical performance by enhancement of the planarity, material clarity, and reduction of the liquid meniscus to facilitate both manual and automated read-out.

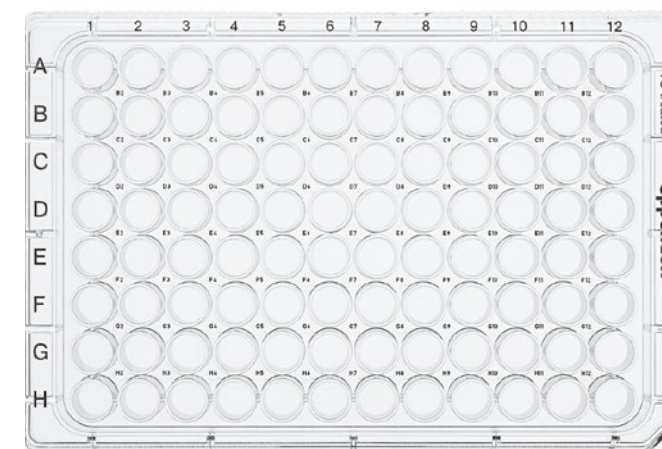

Product features

- > Prevent the edge effect and use 38 % more wells by filling the moat surrounding the outer wells with liquid
- > Level out well-to-well temperature shifts outside the incubator by chimney-well design that enables filling of the inter-well spaces
- > Robust stacking performance by pronounced rims on plate lid and excellent fitting of lid and base when used in stacks
- > Minimized surface contact and reduced contamination risk by lid taps under the plate
- > Easy and fast well identification by contrast rich individual well ID and OptiTrack alphanumeric labeling
- > Easy differentiation of lid and plate bottom due to a pronounced corrugation and wider sized base
- > Optimized gas and temperature transfer when incubating in stacks by pronounced ventilation gaps
- > Optimized microscopical performance due to enhanced planarity, reduction of meniscus and clarity of the material

Plates	6-Well	12-Well	24-Well	48-Well	96-Well
Theoretical total volume	16.0 mL	6.8 mL	3.6 mL	1.5 mL	0.4 mL
Work volume	3 – 5 mL	1 – 2 mL	0.5 – 1 mL	0.3 – 0.5 mL	0.1 – 0.2 mL
Growth area/well¹⁾	940.3 mm ²	391.1 mm ²	208.9 mm ²	85.6 mm ²	37.0 mm ²
Well diameter	34.6 mm	22.4 mm	16.2 mm	10.4 mm	6.8 mm
L x W x H	127.8 x 85.5 x 20.0 mm	127.8 x 85.5 x 20.0 mm	127.8 x 85.5 x 20.0 mm	127.8 x 85.5 x 20.0 mm	127.8 x 85.5 x 14.4 mm
Height with lid	23.2 mm	23.2 mm	23.2 mm	23.2 mm	17.6 mm
Dimensions	Conforms to ANSI/SBS I	Conforms to ANSI/SBS I	Conforms to ANSI/SBS I	Conforms to ANSI/SBS I	Conforms to ANSI/SBS I to V
Centrifugation	Can be centrifuged up to 2,500 x g. When stacked (up to 5 for 96-Well plates and up to 4 for all other formats) can be centrifuged up to 300 x g.				

¹⁾ For the initial seeding of cells, take into account the growth area in order to support optimal cell growth.

Eppendorf Cell Culture Plates

Enhance reproducibility and use up to 38 % more wells

Evaporation of cell culture medium plays a critical role in multi-well based cellular assays because it can deteriorate assay performance. As evaporation mainly affects the peripheral wells of a plate this phenomenon is called the edge effect. With the Eppendorf 96-Well Cell Culture Plate evaporation from the wells can be reduced to a minimum. The plate offers two options for insulating the wells. A moat surrounding the edge wells and the complete chimney design of the inner wells allow filling of the complete inter-well space with liquid. Together this results in a more homogeneous distribution of temperature and humidity throughout the plate and reduces the edge effect.



The filling of the surrounding moat prevents edge effect and yields up to 38 % more usable wells

Filling the complete inter-well space enables for additional insulation of all 96 wells. This not only prevents the edge effect, it also prevents well-to-well temperature shifts outside the incubator

Eppendorf Cell Culture Plate

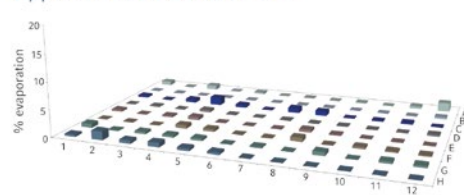

Competitor A

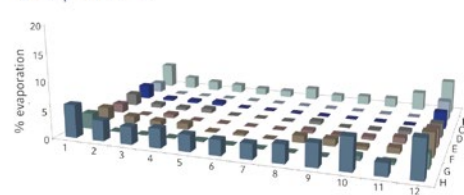

Competitor B

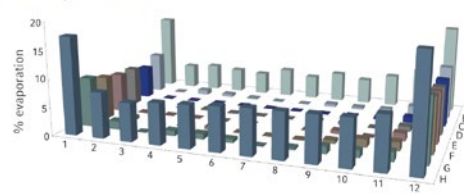

Competitor C

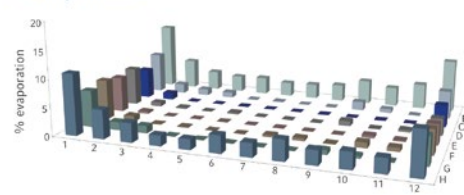

Comparison of evaporation in different 96-well plates

A comparison of different 96-well cell culture plates shows that filling the outer moat of the Eppendorf Cell Culture Plate leads to a superior well-to-well consistency in cell growth in the Eppendorf Cell Culture Plate. By this, the phenomenon of the edge effect can be minimized leading to reproducible performance in cell-based assays. For more information see Application Notes 326 and 384.

Keep your cells warm outside

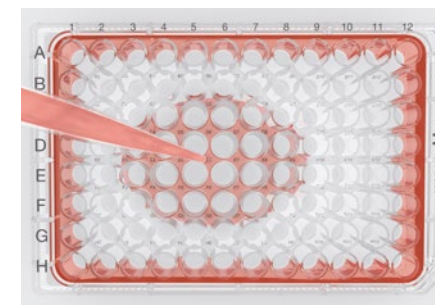

When you take your cells out of the incubator, how do you prevent rapid temperature shifts from affecting your cell performance and experimental reproducibility?

The inter-well spaces of Eppendorf Cell Culture Plates can be filled with liquid before incubation because of the chimney-well design. This keeps your cells warm and cozy outside.

See more cells, harvest more clones

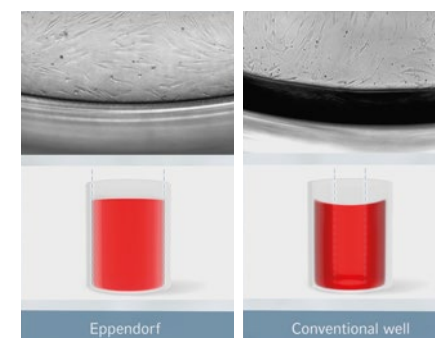

The surface of cell culture vessels needs to be modified physically during production to ensure cell attachment (TC treatment).

Undirected TC treatment causes the medium to form a meniscus and leads to optical interference. This results in shadow formation at the edge of the well.

Here, observation of the growth area is impeded and valuable clones get lost in analysis. A specialized, targeted surface treatment for Eppendorf Cell Culture Plates prevents this effect. Together with enhanced planarity this makes microscopic analysis of cells more reliable and faster.

Put your lids down safely



What do you do with your lids if you need to open the plate completely for full access?

How do you put them on the bench surface without risking contamination?

Eppendorf Cell Culture Plates come with lid taps that minimize the surface contact and therefore significantly reduce the risk of contamination.

Reproducibility in stacks



Did you ever see variations in cell growth on different plates of the same stack?

The reason is often a temperature heterogeneity caused by impaired air-flow between the plates. Ventilation gaps ensure proper airflow and avoid vacuum formation for enhanced handling safety.

Eppendorf Cell Culture Dishes

Description

Whenever you need direct access to your cells, dishes are the format of choice. Eppendorf cell culture dishes were designed with a focus on improved handling and stacking performance to ensure a new level of safe and carefree usage. It all starts with the packaging: the innovative design can be easily opened without tools and resealed without tape. The bags are shrinkable for space-saving and safe storage of unused dishes. With the Eppendorf dishes, a corrugated handling ring provides safety in handling during transportation and expansion of cells. A SplashProtect™ ring inside the dish lid prevents spillage and traps fluid if condensation occurs. Combined with the outstanding, sturdy stacking, our cell culture dishes are unparalleled in their ease of transport and handling, safety, and convenience.

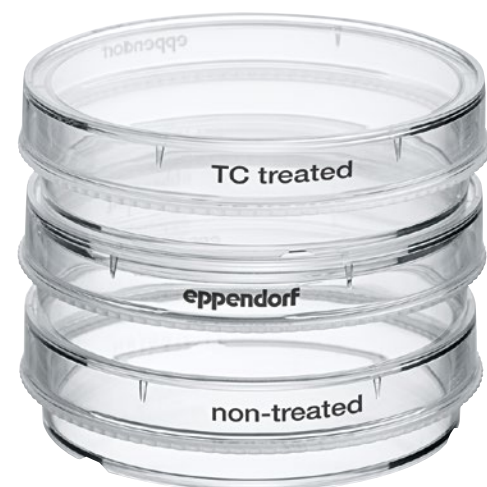

Product features

- > Unsurpassed safety in handling during transportation and while working due to corrugated handling ring
- > SplashProtect™ ring inside of the dish lid traps liquid and prevents spills during transportation or incubation
- > Pronounced rim on dish lid and exact fitting of lid and bottom ensure sturdy, secure stacking
- > Easy differentiation of lid and dish bottom prevents unintended removal of the lid
- > Packaging combines tool-free opening, resealable top and side for tape-free closing, and an easy solution to shrink the package for space-conscious storage
- > SAL 10⁻⁶
- > Certificates for leachables, trace metals, cytotoxicity etc. available

Dishes	35 mm	60 mm	100 mm
Theoretical total volume	8.1 mL	26.6 mL	99.2 mL
Work volume	2.0 – 3.0 mL	3.0 – 5.0 mL	8.0 – 10.0 mL
Growth area	9.5 cm ²	21.9 cm ²	56.8 cm ²
Diameter x height	36.7 x 10.8 mm	59.7 x 14.0 mm	93.8 x 19.4 mm
Height with lid	12.5 mm	15.7 mm	21.3 mm
Centrifugation	Cannot be centrifuged.		



Safe handling by corrugated handling ring



The SplashProtect™ ring on the inside of the lid traps liquid and prevents spills during transport or incubation



Easy and tape-free closing is possible by a package-included resealing clip

Eppendorf Cell Culture Flasks

Description

Flasks are the preferred vessel for long term cultivation or large-scale expansion of cells, providing the best protection against contamination. Unsurpassed protection of your cells from contaminants was one of the key requirements in developing the Eppendorf Cell Culture Flasks. A new, high efficiency air filter technology combines excellent protection with reliable gas exchange. In-line pressure testing for each flask guarantees leakage-free flasks for maximum workflow safety. The unique ConvexAccess™ shape of the neck facilitates the access to the growth area and makes cell seeding and media exchange much more convenient, safe, and reliable.



Product features

- > 100 % Mycoplasma-safe advanced filter technology and optimized gas exchange
- > Patented ConvexAccess™ geometry for facilitated access to growth area and easier and safe cell treatment
- > Defined arrested position on plug-seal caps to prevent undesired closing
- > Anti-rolling cap with corrugation facilitates cultivation steps when the cap needs to be set aside
- > 100 % in-line control for leakage-free flasks and maximum safety
- > Direct surface identification on flask and cap
- > SAL 10⁻⁶
- > Certificates for leachables, trace metals, cytotoxicity etc. available

Flasks	T-25	T-75	T-175
Theoretical total volume	83.6 mL	279.8 mL	662.1 mL
Work volume	3.0 – 7.0 mL	8.0 – 20.0 mL	20.0 – 30.0 mL
Growth area	26.9 cm ²	77.9 cm ²	179.5 cm ²
L x W x H	99.0 x 56.0 x 37.0 mm	163.0 x 82.0 x 46.6 mm	230.0 x 122.0 x 48.0 mm
Centrifugation	Can be centrifuged with the suitable adapters; refer to the manufacturer's instruction.		



ConvexAccess™ neck for better and safer access to the growth surface

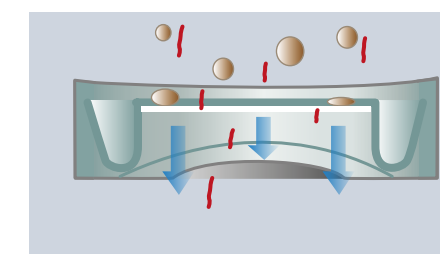

Standard membrane filter

Membrane filter with defined and constant pore size. Particles smaller than this (e.g., Mycoplasma) size can pass through.

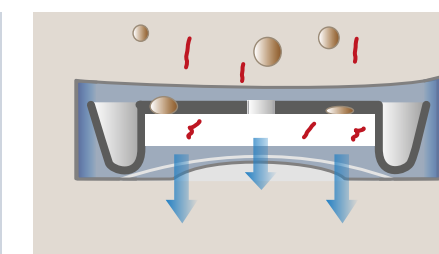

Advanced filter technology of Eppendorf filter caps are 100 % Mycoplasma-safe in realistic and even more challenging experimental scenarios proven by an external testing institute. A certificate can be downloaded.

How to prevent contamination in your cell culture lab?



www.eppendorf.com/ccflasks-video2

Download Whitepaper: Improved Handling of Cells and Protection against Contamination



www.eppendorf.com/whitepaper024

Eppendorf Cell Culture Consumables

Ordering information

Description	Order no.
Eppendorf Cell Culture Plates, 6-Well , Sterile, pyrogen-, DNase-, RNase-, human and bacterial DNA-free. Non-cytotoxic	
TC Treated, 5 mL, 60 plates, individually wrapped	0030 720 113
Non-Treated, 5 mL, 60 plates, individually wrapped	0030 720 016
TC Treated, 5 mL, 100 plates (10 bags x 10 plates)	0030 720 130
Eppendorf Cell Culture Plates, 12-Well , Sterile, pyrogen-, DNase-, RNase-, human and bacterial DNA-free. Non-cytotoxic	
TC Treated, 2 mL, 60 plates, individually wrapped	0030 721 110
Non-Treated, 2 mL, 60 plates, individually wrapped	0030 721 012
Eppendorf Cell Culture Plates, 24-Well , Sterile, pyrogen-, DNase-, RNase-, human and bacterial DNA-free. Non-cytotoxic	
TC Treated, 1 mL, 60 plates, individually wrapped	0030 722 116
Non-Treated, 1 mL, 60 plates, individually wrapped	0030 722 019
Eppendorf Cell Culture Plates, 48-Well , Sterile, pyrogen-, DNase-, RNase-, human and bacterial DNA-free. Non-cytotoxic	
TC Treated, 0.5 mL, 60 plates, individually wrapped	0030 723 112
Non-Treated, 0.5 mL, 60 plates, individually wrapped	0030 723 015
Eppendorf Cell Culture Plates, 96-Well , Sterile, pyrogen-, DNase-, RNase-, human and bacterial DNA-free. Non-cytotoxic	
TC Treated, 0.2 mL, 80 plates, individually wrapped	0030 730 119
Non-Treated, 0.2 mL, 80 plates, individually wrapped	0030 730 011
TC Treated, 0.2 mL, 100 plates (10 bags x 10 plates)	0030 730 135

Ordering information

Description	Order no.
Eppendorf Cell Culture Dishes, 35 mm , Sterile, pyrogen-, DNase-, RNase-, human and bacterial DNA-free. Non-cytotoxic	
TC Treated, 3.0 mL, 300 dishes (30 bags x 10 dishes)	0030 700 112
Non-Treated, 3.0 mL, 300 dishes (30 bags x 10 dishes)	0030 700 015
Eppendorf Cell Culture Dishes, 60 mm , Sterile, pyrogen-, DNase-, RNase-, human and bacterial DNA-free. Non-cytotoxic	
TC Treated, 5.0 mL, 300 dishes (30 bags x 10 dishes)	0030 701 119
Non-Treated, 5.0 mL, 300 dishes (30 bags x 10 dishes)	0030 701 011
Eppendorf Cell Culture Dishes, 100 mm , Sterile, pyrogen-, DNase-, RNase-, human and bacterial DNA-free. Non-cytotoxic	
TC Treated, 10.0 mL, 300 dishes (30 bags x 10 dishes)	0030 702 115
Non-Treated, 10.0 mL, 300 dishes (30 bags x 10 dishes)	0030 702 018

Ordering information

Description	Order no.
Eppendorf Cell Culture Flasks T-25 , Sterile, pyrogen-, DNase-, RNase-, human and bacterial DNA-free. Non-cytotoxic	
with filter cap, TC Treated, 7.0 mL, 192 flasks (24 bags x 8 flasks)	0030 710 126
with plug-seal cap, TC Treated, 7.0 mL, 192 flasks (24 bags x 8 flasks)	0030 710 118
with filter cap, Non-Treated, 7.0 mL, 192 flasks (24 bags x 8 flasks)	0030 710 029
with plug-seal cap, Non-Treated, 7.0 mL, 192 flasks (24 bags x 8 flasks)	0030 710 010
Eppendorf Cell Culture Flasks T-75 , Sterile, pyrogen-, DNase-, RNase-, human and bacterial DNA-free. Non-cytotoxic	
with filter cap, TC Treated, 20.0 mL, 80 flasks (16 bags x 5 flasks)	0030 711 122
with plug-seal cap, TC Treated, 20.0 mL, 80 flasks (16 bags x 5 flasks)	0030 711 114
with filter cap, Non-Treated, 20.0 mL, 80 flasks (16 bags x 5 flasks)	0030 711 025
with plug-seal cap, Non-Treated, 20.0 mL, 80 flasks (16 bags x 5 flasks)	0030 711 017
Eppendorf Cell Culture Flasks T-175 , Sterile, pyrogen-, DNase-, RNase-, human and bacterial DNA-free. Non-cytotoxic	
with filter cap, TC Treated, 30.0 mL, 48 flasks (12 bags x 4 flasks)	0030 712 129
with plug-seal cap, TC Treated, 30.0 mL, 48 flasks (12 bags x 4 flasks)	0030 712 110
with filter cap, Non-Treated, 30.0 mL, 48 flasks (12 bags x 4 flasks)	0030 712 021
with plug-seal cap, Non-Treated, 30.0 mL, 48 flasks (12 bags x 4 flasks)	0030 712 013

CCAdvanced® FN1 motifs

Description

Tired of spending precious lab time coating vessels for your iPSC- or MSC-culture, sometimes even with unpredictable culturing results? How about a xeno-free, or even better, a synthetic surface, ready-to-use for fully defined conditions of your stem cell culture? Improve your experiments with the new CCAdvanced® FN1 motifs cultureware today.

Get a sample, let us support you with transition and convince yourself.



Product features

- > Ready-to-use, synthetic surface for reliable expansion and differentiation
- > Synthetic RGD-derived motifs with optimized steric configuration
- > Easy logistics with long shelf life of 36 months at room temperature
- > Advanced protection against contamination and temperature shifts outside the incubator
- > Guideline for easy transition of iPSCs to FN1 motifs surface available
- > GMP-compliant

Main applications

- Expansion and differentiation of:
- > Stem cells (e.g., hiPSCs, hMSCs)
 - > Primary cells
 - > Other ECM-sensitive eukaryotic cells
 - > Feeder-free cell culture
 - > Restrictive culture conditions (serum-and xeno-free)



Available formats: 6/24/96-well plates, T-75/T-175 flasks, and 30/60 mm dishes

Papers on detailed expansion analysis

hiPSCs - Long-term expansion

Analysis of growth rate, morphology and differentiation potential during 20 successive passages + comparison to Corning® Matrigel®



www.eppendorf.com/appnote389

hMSCs-BM - Long-term expansion

Analysis of growth rate, morphology and differentiation potential during 10 successive passages + comparison to competitors



www.eppendorf.com/appnote390

Handling tips for iPSC-transfer

Get some tips for successful transition of iPSCs from your current surface to CCAdvanced® FN1 motifs



www.eppendorf.com/HandlingTips

Optimized to protect your stem cells

1. Optimized temperature stability during handling outside the incubator with inter-well space filling



2. Safer transport in stacks with stacking aid on the lid

3. Increased handling safety with easy differentiation of lid and plate

Materials	
Material	Polystyrene, meets requirements of USP Class VI
Quality Management System (QMS)	Manufactured in compliance to standard QMS requirements (e.g. ISO 13485)
Surface	Coated with synthetic RGD-derived motifs (optimized steric configuration to mimic ECM proteins)
Xeno-free/synthetic	Manufactured by using animal- and human-component-free materials
Compatibility	Compatible with a broad range of cell dissociation reagents as well as serum-, animal- and human component-free media. More information under www.eppendorf.com/ccc-advanced-shop under „Notes & Papers“
Ambient Conditions	
Working Temperature	15 °C to 37 °C
Storage and shelf life	Shelf life of 36 months from date of manufacture (stored dry at 15 °C to 30 °C)
Certificates	
General	Leachables, Trace metal release, Production conditions, Purity and cytotoxicity
Lot-specific (tested by LADR, an independent accredited laboratory)	<ul style="list-style-type: none"> > Absence of DNase/RNase (Method: DNA/RNA digestion, Limit: 1.0×10^{-6} Kunitz-units (DNase)/ 1.0×10^{-9} Kunitz-units (RNase) > Absence of human or bacterial DNA (Method: qPCR, Limit: < 2 pg for DNA, < 50 fg for RNA) > Endotoxin level (Method: (LAL Test) Eur. Ph. 2.6.14, Limit: < 0.001 EU/ml) > Sterility (Method: Ph. Eur. 2.6.1, Limit: no microbial growth detected) > Cell growth test on Eppendorf Mimitate FN1 motifs consumables
Production conditions	Production takes place in a controlled class 5 clean room environment according to ISO 14644-1 and EU-GMP Grade A. Eppendorf FN1 motifs Consumables are manufactured using aseptic processing according to ISO 13408-1 "Aseptic processing of healthcare products". Each step was validated to ensure that the Eppendorf FN1 motifs Consumables meet the Sterility Assurance Level (SAL) 10^{-3} . The consistent reliable quality of Eppendorf FN1 motifs Consumables is ensured by monitored process controls and checks from the raw material to the final packed product.

Ordering information		
Description	Order no.	
CCCadvanced® FN1 motifs Cell Culture Plates, 6-well, with lid, flat bottom, Sterile, pyrogen-, DNase-, RNase-, human and bacterial DNA-free. Non-cytotoxic, 5 plates, individually wrapped	0038 110 010	
CCCadvanced® FN1 motifs Cell Culture Plates, 24-well, with lid, flat bottom, Sterile, pyrogen-, DNase-, RNase-, human and bacterial DNA-free. Non-cytotoxic, 5 plates, individually wrapped	0038 110 030	
New CCCadvanced® FN1 motifs Cell Culture Plates, 96-well, with lid, flat bottom, Sterile, pyrogen-, DNase-, RNase-, human and bacterial DNA-free. Non-cytotoxic, 5 plates, individually wrapped	0038 110 050	
CCCadvanced® FN1 motifs Cell Culture Flasks, T-75, with filter cap, Sterile, pyrogen-, DNase-, RNase-, human and bacterial DNA-free. Non-cytotoxic, 5 flasks, individually wrapped	0038 120 020	
CCCadvanced® FN1 motifs Cell Culture Flasks, T-175, with filter cap, Sterile, pyrogen-, DNase-, RNase-, human and bacterial DNA-free. Non-cytotoxic, 5 flasks, individually wrapped	0038 120 030	
New CCCadvanced® FN1 motifs Cell Culture Dishes, 60 mm, Sterile, pyrogen free, free of detectable RNase & DNase, free of detectable mouse and human DNA, non-cytotoxic, 18 dishes (3 bags × 6 dishes)	0038 130 020	
New CCCadvanced® FN1 motifs Cell Culture Dishes, 35 mm, Sterile, pyrogen free, free of detectable RNase & DNase, free of detectable mouse and human DNA, non-cytotoxic, 18 dishes (6 bags × 3 dishes)	0038 130 010	

Technical specifications subject to change.

Eppendorf Cell Imaging Consumables

Description

Eppendorf Cell Imaging Consumables allow sophisticated imaging and microscopy applications on an expert level. The products combine premium performance with innovative solutions for demanding optical analysis and fluorescent stainings. Whether you perform inverse microscopy, life cell imaging or fluorescence-based analysis: Find tailored solutions for single and parallel analysis as well as High Content Analysis (HCA) with Eppendorf Cell Imaging Consumables.



Eppendorf Cell Imaging Plates

Eppendorf Cell Imaging Plates with film bottom have excellent light transmission rates even for UV-A and UV-B light. The autofluorescence of the material is lower than a conventional polystyrene bottom with a significant reduction in background signaling. Furthermore, the film bottom enables high gas transfer: oxygen supply and equilibration with the atmosphere are achieved directly through the plate bottom. The glass bottom plates offer excellent planarity for sophisticated microscopic analysis.

Eppendorf Cell Imaging Slides

Eppendorf Cell Imaging Slides and Coverglasses offer a high chemical resistance of materials for reliable and reproducible results in fixation protocols. Tool-free and easy removal of chambers from Cell Imaging Slides and Coverglasses makes working easy, convenient and reliable. Products are available with one to eight chambers to suit a variety of applications.

Eppendorf Cell Imaging Dishes

Eppendorf Cell Imaging Dishes ensure excellent results in high resolution microscopy of living and fixed cells. The bottom of the 35 mm dishes is made from cover glass. The central 18 mm cavity is lower than the level of the surrounding polystyrene dish, which enables the concentration of the cells during seeding on the glass surface and helps to reduce costs of antibodies and dyes. Plate handling and reference are easy, safe, and convenient due to a polygonal gripping zone and directional orientation marking.

Your local distributor: www.eppendorf.com/contact

Eppendorf AG · Barkhausenweg 1 · 22339 Hamburg · Germany · eppendorf@eppendorf.com · www.eppendorf.com · www.eppendorf.com/eshop

Eppendorf Cell Imaging Consumables

Product features

- > Outstanding performance of glass and film surfaces for adherent cells due to innovative tissue culture treatment
- > Low intrinsic fluorescence and high light transmission for enhanced signal-to-noise ratio
- > Easy access to the complete imaging area with immersion lenses for alleviated handling and advanced compatibility with microscopes
- > Ergonomic and robust design
- > Precise planarity supports high resolution microscopes and autofocus systems



Special Features Cell Imaging Plates

- > All plate types have a low skirt design perfectly suited to access all wells with immersion objectives
- > An excellent signal-to-noise ratio can be expected regardless of the plate bottom type
- > Excellent planarity of all plates ensures unsurpassed manual handling and reliable results in automated devices
- > Individually wrapped for reliable purity
- > The ultrathin film bottom allows for high gas permeability and UV-light transparency, ideal for phototoxicity and hypoxic studies



Special Features Cell Imaging Slides and Coverglasses

- > Choose between a microscopic slide with 1 mm thickness or a 170 µm coverglass, both providing excellent signal-to-noise ratios in fluorescent staining protocols
- > Chambers and lids show high chemical resistance, so fixation even with acetone is possible without problems
- > Benefit from easy and tool-free removal of the chambers with minimized glue residues

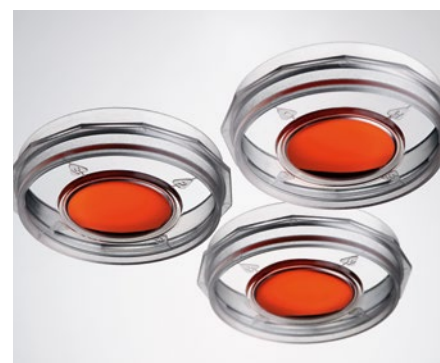

Special Features Cell Imaging Dishes

- > An 18 mm central cavity for defined growth and staining of cells for reduced costs of antibodies and dyes
- > Polygonal gripping zone for improved handling
- > Macroscopic orientation marks facilitate easy orientation
- > Low rim side walls allow easy access for microinjection/micromanipulation
- > Available thickness: 145 µm and 170 µm

How to simplify handling of imaging consumables



www.eppendorf.com/cic-video1

How to mount cells for fluorescent microscopy



www.eppendorf.com/cic-video2

i For more information go to www.eppendorf.com

Technical specifications subject to change.

Ordering information

Description	Order no.
Eppendorf Cell Imaging Plates , with lid, black with clear F-bottom, Sterile, pyrogen-, DNase-, RNase-, human and bacterial DNA-free. Non-cytotoxic	
24-Well Cell Imaging Plate with 170 µm coverglass bottom, individually wrapped, 20 pcs.	0030 741 021
96-Well Cell Imaging Plate with 170 µm coverglass bottom, individually wrapped, 20 pcs.	0030 741 030
24-Well Cell Imaging Plate with 25 µm film bottom, individually wrapped, 20 pcs.	0030 741 005
96-Well Cell Imaging Plate with 25 µm film bottom, individually wrapped, 20 pcs.	0030 741 013

Ordering information

Description	Order no.
Eppendorf Cell Imaging Dishes , with coverglass bottom, Sterile, pyrogen-, DNase-, RNase-, human and bacterial DNA-free. Non-cytotoxic	
35 x 10 mm Cell Imaging Dish 145 µm (1), 2 dishes per bag, 30 pcs.	0030 740 009
35 x 10 mm Cell Imaging Dish 170 µm (1.5), 2 dishes per bag, 30 pcs.	0030 740 017

Ordering information

Description	Order no.
Eppendorf Cell Imaging Slides , Sterile, pyrogen-, DNase-, RNase-, human and bacterial DNA-free. Non-cytotoxic, Sterile, pyrogen-, DNase-, RNase-, human and bacterial DNA-free. Non-cytotoxic	
Cell Imaging Slide with 1 chamber, individually wrapped, 16 pcs.	0030 742 044
Cell Imaging Slide with 2 chambers, individually wrapped, 16 pcs.	0030 742 052
Cell Imaging Slide with 4 chambers, individually wrapped, 16 pcs.	0030 742 060
Cell Imaging Slide with 8 chambers, individually wrapped, 16 pcs.	0030 742 079
Eppendorf Cell Imaging Coverglasses , Sterile, pyrogen-, DNase-, RNase-, human and bacterial DNA-free. Non-cytotoxic, Sterile, pyrogen-, DNase-, RNase-, human and bacterial DNA-free. Non-cytotoxic	
Cell Imaging Coverglass with 1 chamber, individually wrapped, 16 pcs.	0030 742 001
Cell Imaging Coverglass with 2 chambers, individually wrapped, 16 pcs.	0030 742 010
Cell Imaging Coverglass with 4 chambers, individually wrapped, 16 pcs.	0030 742 028
Cell Imaging Coverglass with 8 chambers, individually wrapped, 16 pcs.	0030 742 036

Your local distributor: www.eppendorf.com/contact

Eppendorf AG · Barkhausenweg 1 · 22339 Hamburg · Germany · eppendorf@eppendorf.com · www.eppendorf.com · www.eppendorf.com/eshop



Model	Galaxy® 48 R	CellXpert® C170i
Positioning	Mid size (48 L) CO ₂ incubator for isolation applications (also hypoxic) and small labs	Large (170 L) CO ₂ incubator with advanced interface, easy monitoring/documentation/cleaning etc.
Page(s)	324	326
Capacity	48 L	170 L
Dimensions (W x D x H)	48.3 x 47.5 x 64.5 cm	71.8 x 71.5 x 90.0 cm
Dimensions internal (W x D x H)	40.1 x 30.5 x 40.1 cm	53.9 x 44.5 x 69.2 cm
Weight w/o accessories	31.8 kg	113 kg
Benchtop (B), Under Bench (U), Floor (F) or Stackable (S)	B, U, F, S (x2)	B, U, F, S (x2)
Display	standard display	VisioNize® touch interface
High temperature disinfection (HTD)	120 °C optional	180 °C standard
Sealed inner glass doors	–	standard
Segmented doors	2 segments	4/8 segments
Temperature range	Ambient +4 °C to 50 °C	Ambient +4 °C to 50 °C
Temperature control increment	±0.1 °C	±0.1 °C
Temperature stability at 37 °C	±0.1 °C	±0.1 °C
Temperature uniformity	±0.3 °C	±0.3 °C
CO₂ range	0.1 – 20 %	0.1 – 20 %
CO₂ control increment	±0.1 %	±0.1 %
CO₂ stability at 5 % CO₂	±0.2 %	±0.1 %
CO₂ uniformity	±0.1 %	±0.1 %
O₂ control	0.1 – 19 % or 1 – 19 % optional	1 – 20 %
Number of shelves (standard/max)	3/6	4/8
Copper options	–	chamber, water tray, shelves
Access port	1	2
On-board data logging	standard	standard
Data export interface	RS-232, VisioNize® box	USB, Ethernet, VisioNize® onboard
Water/Humidity monitoring	optional	optional (available beginning of 2020)
BMS relay	standard	standard
Remote Device Monitoring and Notifications (VisioNize®)	VisioNize-qualified	VisioNize-onboard

Model	CellXpert® C170	New Brunswick™ S41i
Positioning	Basic version of the C170i	Large (170 L) CO ₂ incubator with integrated shaker inside
Page(s)	328	331
Capacity	170 L	170 L
Dimensions (W x D x H)	71.8 x 71.5 x 90.0 cm	87.5 x 73 x 85 cm / 34.4 x 28.7 x 33.5 in
Dimensions internal (W x D x H)	53.9 x 44.5 x 69.2 cm	69.1 x 44.4 x 53.8 cm
Weight w/o accessories	105 kg	152 kg
Benchtop (B), Under Bench (U), Floor (F) or Stackable (S)	B, U, F, S (x2)	U, F, S (x2)
Display	standard display	touchscreen
High temperature disinfection (HTD)	140 °C standard	120 °C standard
Sealed inner glass doors	standard	standard
Segmented doors	1	–
Temperature range	Ambient +4 °C to 50 °C	Ambient +4 °C to 50 °C
Temperature control increment	±0.1 °C	±0.1 °C
Temperature stability at 37 °C	±0.1 °C	±0.1 °C
Temperature uniformity	±0.3 °C	±0.25 °C at 37 °C
CO₂ range	0.1 – 20 %	0.1 – 20 %
CO₂ control increment	±0.1 %	±0.1 %
CO₂ stability at 5 % CO₂	±0.1 %	±0.2 %
CO₂ uniformity	±0.1 %	±0.1 %
O₂ control	–	–
Number of shelves (standard/max)	3/8	1/2
Copper options	water tray, shelves	–
Access port	2	1
On-board data logging	–	standard
Data export interface	Ethernet, VisioNize® box	Ethernet, VisioNize® box
Water/Humidity monitoring	–	–
BMS relay	standard	standard
Remote Device Monitoring and Notifications (VisioNize®)	VisioNize-qualified	VisioNize-qualified

Galaxy[®] 48 R

Description

The Galaxy 48 R CO₂ Incubator is a mid-sized, 48 liter incubator designed to optimize performance in applications that require a higher level of isolation and can be used in small labs. The 48 R series of incubators feature a large backlit display with on screen help menu, control and data logging of temperature, CO₂, door openings, alarms, and optional O₂ gas and humidity monitoring.



Product features

- > 48 Liter (1.7 ft³) provides mid-sized capacity within a small footprint
- > Options: High Temp. Disinfection (4 hour at 120 °C), O₂ control (e.g. for hypoxic studies), 2-split inner glass door
- > Fanless design offers more usable space
- > Six-sided direct heating system provides a uniform incubated environment
- > Deep-drawn, easy-to-clean stainless steel chamber without seams or welds
- > Low gas consumption
- > Integrated alarm relay

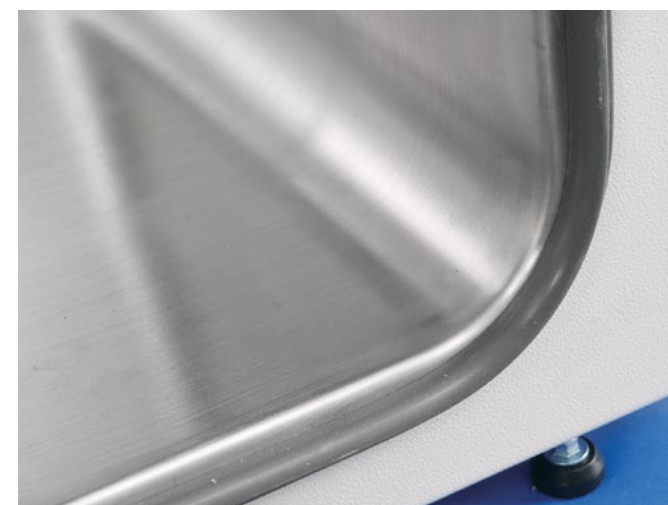

One piece seamless chamber minimizes contamination risk and simplifies cleaning



Integrated, heated, viewing window in outer door allows observation without disturbing cultures

Ordering information

Description	Order no.
Galaxy[®] 48 R, 48 L, Stock, 230 V/50/60 Hz	
Standard	C048300001
1 – 19 % O ₂ Control	C048320001
High-Temp Disinfection	C048310001
High-Temp Disinfection, 1 – 19 % O ₂ Control	C048330001
Galaxy[®] 48 R, 48 L, Built to Order, 230 V/50/60 Hz	
High-Temp Disinfection, 2-Split Inner Door	C048312001
High-Temp Disinfection, 0.1 – 19 % O ₂ Control	C048310041
High-Temp Disinfection, 0.1 – 19 % O ₂ Control, Humidity Package	C048310061
High-Temp Disinfection, 0.1 – 19 % O ₂ Control, 2-Split Inner Door	C048312041
High-Temp Disinfection, 0.1 – 19 % O ₂ Control, 2-Split Inner Door, Humidity Package	C048312061
High-Temp Disinfection, 1 – 19 % O ₂ Control, 2-Split Inner Door	C048332001
High-Temp Disinfection, 1 – 19 % O ₂ Control, 2-Split Inner Door, Humidity Package	C048332011

✂ Ordering information for other voltage options begins on page 450

Galaxy[®] 48 R shelves, pans and stacking stand

Description	Order no.
Lower stacking frame, with casters	6705 070 103
Upper stacking frame	6705 070 111
Under-bench stand	6705 070 120
2-split inner door	6705 851 040
Multi-position shelf rack, 6 position	6705 851 016
Additional shelf, perforated	P0628-5080
Additional humidity tray, stainless steel	P0628-5940

For more information go to www.ependorf.com

Technical specifications subject to change.

Your local distributor: www.ependorf.com/contact
 Eppendorf AG · Barkhausenweg 1 · 22339 Hamburg · Germany · ependorf@ependorf.com · www.ependorf.com · www.ependorf.com/eshop

CellXpert® C170i

Make your cell culture ready for the future

Are you looking for a 170 L-class CO₂ incubator that provides flexibility for the future, makes monitoring and documentation easy and provides optimized growth conditions, even for your sensitive cells? An incubator that also saves money and is produced with highest quality standards? Welcome the new CellXpert C170i and learn more below.

CellXpert – a new family of Eppendorf CO₂ incubators



Stay flexible for the future

- > In-field changeable door handle position (left/right)
- > O₂-control upgradeable in-field later
- > VisioNize® touch interface for easy and full control over parameter setting, monitoring, documentation, customized tasks and alarms
- > Easy documentation
- > Two access ports for experiments inside the incubator with user-validated devices

Safety for your cells

- > Uniform temperature verified at 27 points (German DIN 12880 norm) by four temperature sensors and four individually controlled heating circuits
- > Fast temperature and CO₂ recovery < 5 min without overshoot with advanced microprocessor control
- > 180 °C high temperature disinfection
- > Vibration and turbulence protection by fan-less design

Save money

- > Up to 25 % more usable space with fan-less design
- > Significantly reduced gas consumption by smart gas control
- > No internal spare parts that need regular replacement (Hepa-filters, UV-lamps etc.)
- > Increased workflow speed for handling, cleaning and documentation

For more information go to www.eppendorf.com

Technical specifications subject to change.



Full control and easy documentation with the intuitive to use, clearly arranged VisioNize® touch interface. Export performance charts or HTD-protocols within seconds via the integrated USB ports at the front.

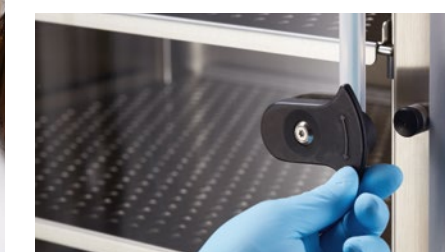

Easy to handle: The magnetic door locking concept significantly reduces opening forces of the tightly sealed doors. The dual way inner door latches are simply pulled to open and pushed or turned to close the inner door. This way, the mechanism can adjust to different user habits. It also offers advanced vibration protection for sensitive cells when the door latch is turned to close.

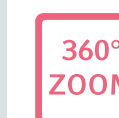
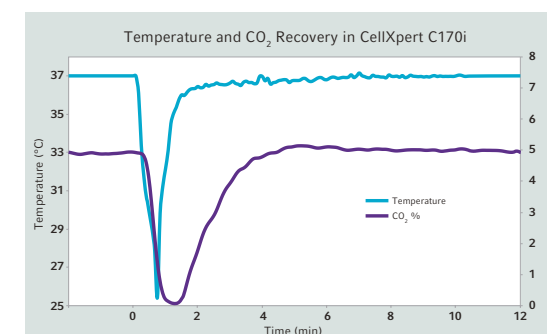

Highly homogenous growth conditions and fast recovery: A fast feedback CO₂ sensor, 4 temperature sensors, four individually controlled heating circuits and advanced microprocessor control ensure optimal growth conditions.

Want to know more about the CellXpert and see it in 360°?
www.eppendorf.com/cellxpert

CellXpert® C170i

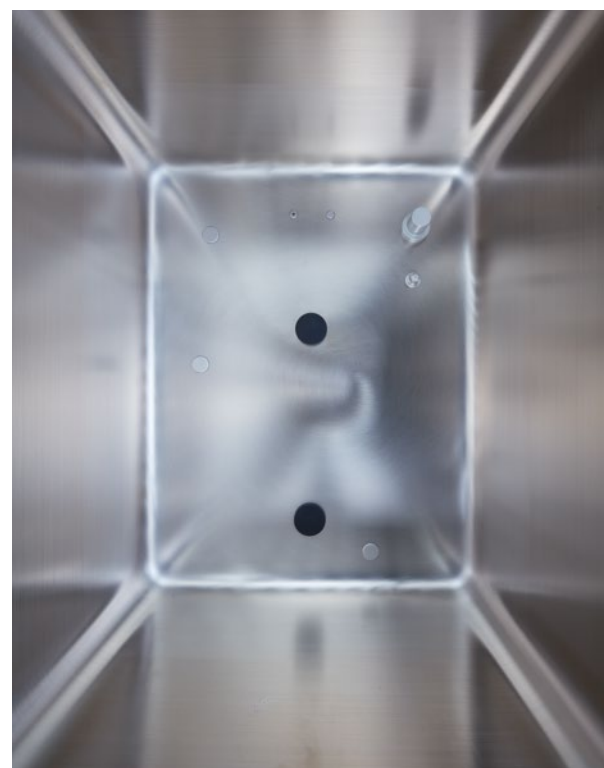

Up to 25 % more space: The fan-less design, the smart racking system and an innovative insulation concept ensure highest capacity with minimal footprint.

Easy cleaning and disinfection: Disassemble the interior within 40 seconds, quickly wipe the seamless chamber, and start the HTD by push of a button. If it is easy, it gets done.

	C170i	C170
Display	VisioNize® touch interface, onboard data log	Standard display
High temperature disinfection	180 °C standard (protocol downloadable)	140 °C standard
O₂ control	1 - 20 % optional (upgradeable in-field later)	-
In-field upgradeable options	<ul style="list-style-type: none"> > O₂ control > humidity monitoring¹⁾ > water monitoring¹⁾ > door handle position 	<ul style="list-style-type: none"> > door handle position
Inner door latch	magnetic, dual way	magnetic, single way
VisioNize®	onboard	box
VisioNize® device management software including:	standard	optional
<ul style="list-style-type: none"> > User management > Performance charts > HTD-wizard > Customized tasks > Remote monitoring > Notifications 		
USB port	2 (front)	no

¹⁾ Available beginning of 2020

Ordering information					
Segmented doors	Door handle	O ₂ control	Water/Humidity monitoring	Copper package	Order no.
1	right	-	-	-	6731 000 011
1	right	-	-	yes	6731 000 511
1	right	-	humidity monitoring	-	6731 000 111
1	right	-	water-level monitoring	-	6731 000 211
1	right	-	water and humidity monitoring package	-	6731 000 311
1	right	yes	-	-	6731 001 011
1	right	yes	water and humidity monitoring package	yes	6731 001 811
1	left	-	-	-	6731 000 021
1	left	-	-	yes	6731 000 521
1	left	-	humidity monitoring	-	6731 000 121
1	left	-	water-level monitoring	-	6731 000 221
1	left	-	water and humidity monitoring package	-	6731 000 321
1	left	yes	-	-	6731 001 021
1	left	yes	water and humidity monitoring package	yes	6731 001 821
4	right	-	-	-	6731 000 041
4	right	-	water and humidity monitoring package	-	6731 000 341
4	right	-	water and humidity monitoring package	yes	6731 000 841
4	right	yes	-	-	6731 001 041
4	right	yes	water and humidity monitoring package	-	6731 001 341
4	left	-	-	-	6731 000 051
4	left	-	water and humidity monitoring package	-	6731 000 351
4	left	-	water and humidity monitoring package	yes	6731 000 851
4	left	yes	water and humidity monitoring package	-	6731 001 351
4	left	yes	-	-	6731 001 051
8	right	yes	-	-	6731 001 081
8	left	yes	-	-	6731 001 091

CellXpert® C170/C170i shelves, pans and stacking stand

Description	Order no.
Stacking stand, lower frame, with castors	6731 070 093
Stacking stand, upper frame	6731 070 085
Shelves, for 170 L incubators, 2 pcs.	6710 859 009
Multi-position shelf rack, 8 position	P0628-6390
Copper water tray, for 170 L incubators	P0628-6260
Water tray, for 170 L incubators	P0628-6140
Copper shelves, for 170 L incubators, 2 pcs.	6710 859 106
Set of copper water tray and 4 copper shelves for 170 L incubators	6731 080 013



Want to know more about smart cultivation with VisioNize® or eLabJournal®?

Visit our website to learn more and order:

www.eppendorf.com/you-and-your-lab

For more information go to www.eppendorf.com

CellXpert® C170

A reliable partner for your cell culture

Looking for a CO₂ incubator with a highly uniform atmosphere, fast recovery and effective contamination protection? A device that is easy to clean and use with a high useable volume to footprint ratio? Learn more about the CellXpert C170, the basic version of the C170i. CellXpert – a new family of Eppendorf CO₂ incubators.



Optimal growth conditions

- > Uniform temperature verified at 27 points (German DIN 12880 norm) by multiple temperature sensors and four individually controlled heating circuits
- > Fast temperature and CO₂ recovery < 5 min without overshoot with advanced microprocessor control
- > Vibration and turbulence protection by fan-less design

Effective contamination prevention

- > 140 °C High Temperature Disinfection
- > Easy cleaning with seamless chamber, fast disassembling
- > Fan-less design
- > No internal Hepa-filters that potentially contaminate the chamber after HTD

Save money

- > Up to 25 % more usable space with fan-less design
- > No internal spare parts that need regular replacement (Hepa-filters, UV-lamps etc.)
- > Increased workflow speed for handling and cleaning

Ordering information

Description	Order no.
CellXpert® C170, non-segmented inner door, handle right side, water tray, shelves, 220 – 240 V/50 – 60 Hz	6734 000 011

✂ Ordering information for other voltage options begins on page 450

New Brunswick™ S41i

Description

Reproducibility of your results, e.g. in protein expression, highly relies on atmosphere accuracy and protection from fan-induced medium evaporation? You cannot risk loss of samples due to contamination of your shaker? And you do not want to spend too much time on programming, changing CO₂ cylinders or reliable cleaning?

Have a look at the smart and versatile solutions the S41i CO₂ incubator shaker offers and compare it with your current solution.



New Brunswick™ S41i	
Universal platform	M1334-9920
125 mL Erlenmeyer flasks	20
250 mL Erlenmeyer flasks	16
500 mL Erlenmeyer flasks	12
1 L Erlenmeyer flasks	10
2 L Erlenmeyer flasks	4
2 L Lauber Thompson	4
2.8 L Fernbach flasks	3
3 L Erlenmeyer flasks	3
4 L Erlenmeyer flasks	3
Test tube rack, small, 30.0 × 8.0 × 12.9 cm	6
Test tube rack, medium, 36 × 8 × 12.9 cm	3
Test tube rack, large, 45 × 8 × 12.9 cm	3
Platform size	36 × 61 cm (14 × 24 in)

Product features

- > Experimental flexibility: Perforated shelf allows for static incubation at the same time as shaking
- > Stable, uniform and vibration-free shaking: robust Innova triple eccentric drive
- > Saves gas and provides an optimal growing atmosphere: Smart gas control (0.1 - 20% CO₂)
- > Ensures surface sterility: automatic high temperature disinfection and inner/outer door
- > Fast and reliable cleaning: Smooth, seamless chamber
- > Increaseable capacity: Two devices stackable
- > Precise and easy control: Intuitive touch screen
- > Humidification included
- > Shaking speed 25 - 400 rpm (25 - 300 rpm if stacked)

New Brunswick™ S41i



Applications

- > Culturing of suspension cells requiring gentle agitation
- > Protein expression
- > Incubating adherent cells on the shelf included with the unit: adding a 2nd static shelf and using the shaking platform as a 3rd shelf
- > Adherent cells such as stem cells that require both incubation and periodic gentle shaking

Ordering information

Description	Order no.
New Brunswick™ S41i , 170 L, CO ₂ incubator shaker with inner shelf and touch screen control, 1 shelf, 1 (2. optional) shelves, 230 V, orbit diameter 2.5 cm (1 in)	S41I230011
Interchangeable platform for New Brunswick™ S41i , 35.6 × 61 cm (14 × 24 in)	
Universal platform	M1334-9920
125 mL Erlenmeyer flask dedicated platform, comes complete with 32 clamps installed	M1334-9921
250 mL Erlenmeyer flask dedicated platform, comes complete with 24 clamps installed	M1334-9922
500 mL Erlenmeyer flask dedicated platform, comes complete with 15 clamps installed	M1334-9923
1 L Erlenmeyer flask dedicated platform, comes complete with 11 clamps installed	M1334-9924
2 L Erlenmeyer flask dedicated platform, comes complete with 6 clamps installed	M1334-9925
2.8 L Erlenmeyer flask dedicated platform, comes complete with 3 clamps installed	M1334-9926
4 L Erlenmeyer flask dedicated platform, comes complete with 3 clamps installed	M1334-9927
Stacking kit , allows up to 2 each New Brunswick™ S41i shakers to be stacked one on top of the other	P0628-6502
Additional shelf for New Brunswick™ S41i , perforated, can easily be added to the New Brunswick S41i for static cell culture of adherent cells	P0628-6181
Sticky pad adapter kit , 2 anodized aluminum sheets, each 15.2 × 45.7 cm (6 × 18 in)	M1250-9504
Sticky pad , 20 × 20 cm (8 × 8 in)	M1250-9700

✎ Ordering information for other voltage options begins on page 450

CO₂ Incubators Accessories



CO₂ Incubators Accessories

Description	Order no.
Galaxy® CO₂, O₂, and RH gas analyzer	P0628-7890
Autozero port filter	P0628-5060
CO₂ cylinder auto-changeover controller	P0628-5000
In-line gas filter for Eppendorf CO₂ incubators, 2 pieces	6710 070 251
Temperature probe, 5 mm tip for gas analyzer	P0628-7881
Temperature probe, 100 mm tip for gas analyzer	P0628-7880
Galaxy® CO₂ gas analyzer	P0628-6150
Galaxy® CO₂ and O₂ gas analyzer	P0628-6831



Model	Innova® S44i	Innova® 44/44R	Innova® 43/43R
Page(s)	338	340	341
Temperature range	Incubated: 5 °C above ambient to 80 °C; Refrigerated: 20 °C below ambient (min. 4 °C) to 80 °C.	5 °C above ambient to 80 °C. (Innova 44R: 20 °C below ambient (min. 4 °C) to 80 °C) ¹⁾	5 °C above ambient to 80 °C. (Innova 43R: 20 °C below ambient (min. 4 °C) to 80 °C) ¹⁾
Temperature uniformity	±0.25 °C at 37 °C and 250 rpm	±0.25 °C at 37 °C	±0.25 °C at 37 °C
Speed range	2.5 cm orbit: 20 – 400 rpm, 5.1 cm orbit: 20 – 300 rpm	25 – 400 rpm with 2.5 cm orbit; 25 – 300 rpm with 5.1 cm orbit or 2 stacked units; 25 – 250 rpm with 3 stacked units	25 – 500 rpm with 2.5 cm orbit; 25 – 300 rpm with 5.1 cm orbit
Orbit	2.5/5.1 cm (1/2 in)	2.5/5.1 cm (1/2 in)	2.5/5.1 cm (1/2 in)
Benchtop (B), Under Bench (U), Floor (F) or Stackable (S)	F, S (x3)	F, S (x3)	F
Platform size	76 × 62 cm (30 × 24 in)	76 × 46 cm (30 × 18 in)	76 × 46 cm (30 × 18 in)
Slide-out platform	yes	yes	no
Drive mechanism	Eppendorf X-Drive with semi-automated counterbalance setting	Triple-eccentric counterbalanced drive	Triple-eccentric counterbalanced drive
Motor type	Solid state, DC brushless motor	Solid state, DC brushless motor	Solid state, DC brushless motor
Dimensions (W × D × H)	118.2 × 86.9 × 63 cm / 46.5 × 34.2 × 24.8 in	134.9 × 84.3 × 66 cm / 53.1 × 33.2 × 26 in	115.6 × 81.3 × 103.1 cm / 45.5 × 20 × 40.6 in
External height (with lid/door open)	115.8 cm (45.6 in) excluding base	113.9 cm (47 in) excluding base	165.1 cm (65 in)
External depth (with lid/door open)	–	–	–
Space-saving glide-up doors	yes	yes	no
Weight w/o accessories	198 kg / 437 lb	238 kg / 525 lb	209 kg / 445 lb
Audible and visual alarms	yes	yes	yes
Available program modes	> Constant speed and temperature > Time shaking mode up to 95:59 hours > Multi step programming/cycling – Parameters include shaking speed, temperature, time and (optional) photosynthetic light intensity	> Constant speed and temperature > Programmable multi-steps > RS-232 communication port	> Constant speed and temperature > Programmable multi-steps > RS-232 communication port
Steps per program	unlimited	15	15
Stored programs	unlimited	4	4
Timer	0.01 – 95.59 h, continuous	0.01 – 99.59 h, continuous	0.01 – 99.59 h, continuous
Memory	Non volatile with automatic power failure restart	Non volatile with automatic power failure restart	Non volatile with automatic power failure restart
cETLus and CE marked	yes	yes	yes
Remote Device Monitoring and Notifications (VisioNize®)	VisioNize-onboard	VisioNize-qualified	VisioNize-qualified

¹⁾ Configuration dependent



Model	Innova® 42/42R	Innova® 40/40R	Excella® E25/E25R	Excella® E24/E24R
Page(s)	342	343	344	345
Temperature range	5 °C above ambient to 80 °C. (Innova 42R: 20 °C below ambient (min. 4 °C) to 80 °C) ¹⁾	5 °C above ambient to 80 °C. (Innova 40R: 15 °C below ambient (min. 4 °C) to 80 °C)	7 °C above ambient to 60 °C. (Excella 25R: 15 °C below ambient (min. 4 °C) to 60 °C)	7 °C above ambient to 60 °C. (Excella 24R: 15 °C below ambient to 60 °C)
Temperature uniformity	±0.25 °C at 37 °C	±0.25 °C at 37 °C	±0.5 °C at 37 °C	±0.1 °C at 37 °C
Speed range	25 – 400 rpm; 25 – 300 rpm when using flasks > 500 mL in stacked devices	25 – 500 rpm	50 – 400 rpm	50 – 400 rpm
Orbit	1.9/2.5 cm (0.75/1 in)	1.9/2.5 cm (0.75/1 in)	2.5 cm (1 in)	1.9 cm (0.75 in)
Benchtop (B), Under Bench (U), Floor (F) or Stackable (S)	B, U, S (x2)	B	F	B
Platform size	46 × 46 cm (18 × 18 in)	46 × 46 cm (18 × 18 in)	76 × 46 cm (30 × 18 in)	46 × 46 cm (18 × 18 in)
Slide-out platform	no	no	no	no
Drive mechanism	Triple-eccentric counterbalanced drive	Triple-eccentric counterbalanced drive	Heavy-duty uniecentric counterbalanced drive	Heavy-duty uniecentric counterbalanced drive
Motor type	Solid state, DC brushless motor	Solid state, DC brushless motor	Solid state, DC brushless motor	Solid state, DC brushless motor
Dimensions (W × D × H)	63.5 × 74.5 × 881.8 cm / 25 × 29.3 × 32.8 in	55.9 × 76.2 × 61 cm / 22 × 30 × 24 in	127 × 77 × 105.9 cm / 50 × 30.5 × 41.7 in	56 × 76.2 × 61 cm / 22 × 30 × 24 in
External height (with lid/door open)	–	101.6 cm (40 in)	165.7 cm (65.2 in)	101.6 cm (40 in)
External depth (with lid/door open)	131 cm (51.6 in)	–	–	–
Space-saving glide-up doors	no	no	no	no
Weight w/o accessories	98 kg / 217 lb	60 kg / 133 lb	204.5 kg / 450 lb	60 kg / 133 lb
Audible and visual alarms	yes	yes	yes	yes
Available program modes	> Constant speed and temperature > Programmable multi-steps > RS-232 communication port	> Constant speed and temperature > Programmable multi-steps > RS-232 communication port	> Constant speed and temperature > Timed shaking	> Constant speed and temperature > Timed shaking
Steps per program	15	15	–	–
Stored programs	4	4	–	–
Timer	0.01 – 99.59 h, continuous	0.01 – 99.59 h, continuous	0.1 – 99.9 h	0.1 – 99.9 h
Memory	Non volatile with automatic power failure restart	Non volatile with automatic power failure restart	Non volatile with automatic power failure restart	Non volatile with automatic power failure restart
cETLus and CE marked	yes	yes	yes	yes
Remote Device Monitoring and Notifications (VisioNize®)	VisioNize-qualified	VisioNize-qualified	–	–



Model	Innova® 2350
Page(s)	347
Dimensions (W x D x H)	91.4 x 61 x 16.3 cm / 36 x 24 x 6.4 in
Weight w/o accessories	52 kg / 115 lb
Audible and visual alarms	yes
Drive mechanism	Triple-eccentric counterbalanced drive
cETLus and CE marked	yes
Benchtop (B), Under Bench (U), Floor (F) or Stackable (S)	B
Motor type	Solid state, DC brushless motor
Orbit	2.5/5.1 cm (1/2 in)
Platform size	91 x 61 cm (36 x 24 in)
Timer	0.1 – 99.9 h
Remote Device Monitoring and Notifications (VisioNize®)	-

Model	Innova® 2300
Page(s)	347
Dimensions (W x D x H)	76.2 x 56.6 x 16.3 cm / 30 x 22.3 x 6.4 in
Weight w/o accessories	48 kg / 105 lb
Audible and visual alarms	yes
Drive mechanism	Triple-eccentric counterbalanced drive
cETLus and CE marked	yes
Benchtop (B), Under Bench (U), Floor (F) or Stackable (S)	B
Motor type	Solid state, DC brushless motor
Orbit	2.5/5.1 cm (1/2 in)
Platform size	76 x 46 cm (30 x 18 in)
Timer	0.1 – 99.9 h
Remote Device Monitoring and Notifications (VisioNize®)	-



Model	Innova® 2150
Page(s)	348
Dimensions (W x D x H)	60.1 x 59.1 x 16.3 cm / 24 x 23.3 x 6.4 in
Weight w/o accessories	36 kg / 80 lb
Audible and visual alarms	yes
Drive mechanism	Triple-eccentric counterbalanced drive
cETLus and CE marked	yes
Benchtop (B), Under Bench (U), Floor (F) or Stackable (S)	B
Motor type	Solid state, DC brushless motor
Orbit	1.9 cm (0.75 in)
Platform size	61 x 46 cm (24 x 18 in)
Timer	0.1 – 99.9 h
Remote Device Monitoring and Notifications (VisioNize®)	-

Model	Innova® 2100
Page(s)	348
Dimensions (W x D x H)	48 x 55.5 x 16.3 cm / 19 x 21.9 x 6.4 in
Weight w/o accessories	34 kg / 75 lb
Audible and visual alarms	yes
Drive mechanism	Triple-eccentric counterbalanced drive
cETLus and CE marked	yes
Benchtop (B), Under Bench (U), Floor (F) or Stackable (S)	B
Motor type	Solid state, DC brushless motor
Orbit	1.9 cm (0.75 in)
Platform size	46 x 46 cm (18 x 18 in)
Timer	0.1 – 99.9 h
Remote Device Monitoring and Notifications (VisioNize®)	-



Model	Innova® 2050
Page(s)	349
Dimensions (W x D x H)	43 x 37 x 14.6 cm / 17 x 14.5 x 5.8 in
Weight w/o accessories	16 kg / 35 lb
Audible and visual alarms	yes
Drive mechanism	Triple-eccentric counterbalanced drive
cETLus and CE marked	yes
Benchtop (B), Under Bench (U), Floor (F) or Stackable (S)	B
Motor type	Solid state, DC brushless motor
Orbit	1.9 cm (0.75 in)
Platform size	41 x 31 cm (16 x 12 in)
Timer	0.1 – 99.9 h
Remote Device Monitoring and Notifications (VisioNize®)	-

Model	Innova® 2000
Page(s)	349
Dimensions (W x D x H)	35.5 x 37 x 14.6 cm / 14 x 14.5 x 5.8 in
Weight w/o accessories	15 kg / 33 lb
Audible and visual alarms	yes
Drive mechanism	Triple-eccentric counterbalanced drive
cETLus and CE marked	yes
Benchtop (B), Under Bench (U), Floor (F) or Stackable (S)	B
Motor type	Solid state, DC brushless motor
Orbit	1.9 cm (0.75 in)
Platform size	33 x 28 cm (13 x 11 in)
Timer	0.1 – 99.9 h
Remote Device Monitoring and Notifications (VisioNize®)	-

epServices
for premium performance

On page 398 you will find detailed information on services for these products!

Enabling Connections



VisioNize® box:

The easy-to-install hardware hub connects your VisioNize-qualified devices to VisioNize. The hub works as a translation system enabling data collection of the device data in VisioNize. Gain access to the functions and features of VisioNize. Learn more on the page 11.

www.eppendorf.com/visionize

Ordering information

Description	Order no.
VisioNize® box, with mains/power adapter	1006 000 009
VisioNize® box cable, Ethernet, length 5 m	1006 073 006

Innova® S44i

Description

The Innova S44i is a large capacity, temperature controlled (refrigerated) stackable shaker allowing the use of high-volume flasks in large numbers in a compact footprint. The iconic slide up door provides easy access to your samples. The Eppendorf X-Drive allows for shaking high loads at high speeds – even when stacked. When there is an instance of an unbalanced load, the X-Drive's counterbalance adjustment allows for smooth shaking. The optional photosynthetic LED lightbank provides the ability to evenly light the entire platform across a wide intensity range – and it's programmable. The VisioNize touch interface introduces onboard monitoring, user management and the ability to export data via USB; or network integration via ethernet. A comprehensive service offering including IQ/OQ is also available.



Product features

- > High flask capacity in a smaller footprint to grow more cells in less space – 33 % more 500 mL flask capacity and 80 % more weight capacity than Innova 44
- > The new Eppendorf X-Drive with semi-automated counterbalance technology for smooth and vibration-free agitation
- > Double- or triple- stack the S44i for increased capacity
- > VisioNize touch interface with flexible programming, integrated data- and eventlogging function and user management capability
- > New slide-out platform design with quick-release handle provides easy access to samples even at the back of the platform
- > Glide-up door for space-saving placement and convenient chamber access. Easily reach all your samples using the slide-out platform
- > Optional static shelf for parallel static cultivation
- > Photosynthetic LED light bank option provides uniform light across the platform for photosynthetic organisms

Applications

- > Grow bacteria, yeast, fungus, photosynthetic organisms
- > Plasmid DNA production and protein expression
- > Process optimization and media development
- > Media screening and optimization
- > Seed cultures for bioprocess scale-up
- > Biofuel research
- > Food quality testing



This icon tags VisioNize-onboard devices which can be conveniently connected to VisioNize for device monitoring and notifications customizable to meet your needs.

Further information are available at page 11.



LED lamps with adjustable intensity for uniform light distribution across the platform



Eppendorf X-Drive with five eccentric mounting points and adjustable counterbalance provides dependable operation

Technical specifications	
Model	Innova® S44i
Temperature range	Incubated: 5 °C above ambient to 80 °C; Refrigerated: 20 °C below ambient (min. 4 °C) to 80 °C.
Temperature accuracy	±0.1 °C at 37 °C
Temperature uniformity	±0.25 °C at 37 °C and 250 rpm
Agitation	
Speed	2.5 cm (1 in) orbit: 20 – 400 rpm 5.1 cm (2 in) orbit: 20 – 300 rpm
Orbit	2.5/5.1 cm (1/2 in)
Drive mechanism	Eppendorf X-Drive with semi-automated counterbalance setting
Maximum platform load	35.4 kg (78 lb)
Available program modes	> Constant speed and temperature > Time shaking mode up to 95:59 hours > Multi step programming/cycling – Parameters include shaking speed, temperature, time and (optional) photosynthetic light intensity
Data export interface	USB, Ethernet
Photosynthetic LED light bank	
Intensity range	15 to 150 PAR adjustable in increments of 1 parProgrammable (e.g. day night cycles)Programmable (e.g. day night cycles)
Main wavelength	Wide band spectrum; 400 – 700 nm
Net weight	Incubated: 181.4 kg (411 lb) Refrigerated: 188.2 kg (437 lb)
Dimensions (W × D × H)	118.2 × 86.9 × 63 cm / 46.5 × 34.2 × 24.8 in

Ordering information

Description	Order no.
Innova® S44i , incubated, 230 V, orbit diameter 2.5 cm (1 in)	S44I300001
Innova® S44i , refrigerated, 230 V, orbit diameter 2.5 cm (1 in)	S44I310001
Innova® S44i , refrigerated, photosynthetic LED light bank, 230 V, orbit diameter 2.5 cm (1 in)	S44I311001
Innova® S44i , incubated, 230 V, orbit diameter 5.1 cm (2 in)	S44I320001
Innova® S44i , refrigerated, 230 V, orbit diameter 5.1 cm (2 in)	S44I330001
Innova® S44i , refrigerated, photosynthetic LED light bank, 230 V, orbit diameter 5.1 cm (2 in)	S44I331001
10.5 cm (4.1 in) positioning base	S44I041001
30.7 cm (12.1 in) positioning base	S44I041002
Stacking kit for double stack of Innova® S44i	S44I041005
Stacking kit for Innova® S44i to Innova® 44/44R	S44I041006
Stacking kit for triple stack of Innova® S44i	S44I041003
Static incubation shelf	S44I042001
Darkening window shade, (removable)	S44I042002
Universal platform, (76 × 62 cm)	S44I040001
125 mL Erlenmeyer flask dedicated platform, 86 clamps	S44I040002
250 mL Erlenmeyer flask dedicated platform, 53 clamps	S44I040003
500 mL Erlenmeyer flask dedicated platform, 39 clamps	S44I040004
1 L Erlenmeyer flask dedicated platform, 23 clamps	S44I040005
2 L Erlenmeyer flask dedicated platform, 15 clamps	S44I040006

✎ Ordering information for other voltage options begins on page 450

New Brunswick™ Innova® 44/44R

Description

The Innova 44 and 44R (refrigerated) stackable shakers are designed for culturing a wide variety of organisms in flasks up to 5L. The cast iron triple-eccentric counterbalanced drive is specifically designed to support high-speed applications and heavy workloads – the design has stood the test of time for over 70 years and continues to enable scientists today. A water reservoir with drain allows for humidification of the chamber, whilst protecting the drive unit from any spills. The simple user interface allows for easy programming of speed, temperature, time and when installed, the photo-synthetic light bank. The VisioNize box can be added to enhance monitoring and adds notifications functionality. Regular servicing can be carried out in-situ, allowing for minimized downtime.



Product features

- > Stackable – up to three units for optimized space savings
- > Continuous mode or multiple-step programming
- > Programmable Innova controls automatically change temperature, speed, and optional photosynthetic and UV germicidal lights at timed intervals (Store up to 4 individual programs with 15 steps each)
- > Accessory platform (sold separately) accommodates flasks up to 5 L
- > Slide-out platform mechanism – provides easy access to flasks
- > Built in spill pan catches accidental spills to aid cleaning and protects drive mechanism. Also allows use as a water reservoir to reduce sample evaporation
- > Pull-out service module allows access to all electronic and heating/cooling components for easy service, without having to unstack the units

Ordering information

Description	Order no.
New Brunswick™ Innova® 44	
230 V, orbit diameter 2.5 cm (1 in)	M1282-0002
230 V, orbit diameter 5.1 cm (2 in)	M1282-0012
New Brunswick™ Innova® 44R	
230 V, orbit diameter 2.5 cm (1 in)	M1282-0006
230 V, orbit diameter 5.1 cm (2 in)	M1282-0016
Stacking kit , for stacking one additional 44 or 44R (3 × Innova 44/44R can be placed in a single stack)	M1282-0500
Photosynthetic light bank , for Innova® 44R only, orbit diameter 2.5/5.1 cm (1/2 in)	M1282-9922
12-port gassing manifold , for Innova® 44R, orbit diameter 2.5/5.1 cm (1/2 in)	M1282-0291
Humidity monitor , for Innova® 44R, orbit diameter 2.5/5.1 cm (1/2 in)	M1282-5011
UV germicidal light , for Innova® 44R only, orbit diameter 2.5/5.1 cm (1/2 in)	M1282-9921
Remote alarm option , for Innova® 44/44, Innova® 43/43, Innova® 42/42 or Innova® 40/40	M1320-8029
Universal platform for Innova® 44/44R , 76 × 46 cm, not interchangeable with other 76 × 46 cm platforms	
Universal platform	M1282-9904
Aluminum platform for Innova® 44/44R , 76 × 46 cm, not interchangeable with other 76 × 46 cm platforms	
125 mL Erlenmeyer flask dedicated platform	M1282-9905
250 mL Erlenmeyer flask dedicated platform	M1282-9906
500 mL Erlenmeyer flask dedicated platform	M1282-9907
1 L Erlenmeyer flask dedicated platform	M1282-9908
2 L Erlenmeyer flask dedicated platform	M1282-9909
Sticky pad platform, sticky pads sold separately	M1282-9913
Heavy duty 0.95 cm-thick aluminum plate platform for Innova® 44/44R only , 76 × 46 cm, not interchangeable with other 76 × 46 cm platforms. Heavy-duty platforms are recommended for shaking full loads of flasks, 1 L and larger, containing more than 20 % volume or with baffles	
Heavy duty universal platform	M1282-9915
1 L Erlenmeyer flask dedicated platform, heavy duty	M1282-9925
2 L Erlenmeyer flask dedicated platform, heavy duty	M1282-9926
Positioning bases , increases the height of the shaker for easier access, for Innova® 44/44R	
10.2 cm, short	M1282-0600
30.5 cm, medium	M1282-0800
40.6 cm, tall	M1282-0700

New Brunswick™ Innova® 43/43R

Description

The Innova 43 and 43R (refrigerated) shakers are the perfect choice for handling large volumes of cultures with precision and ease. The top loading design allows for vertical placement of the flasks. A pedal operated lid and a window in the sidewall overlooking the samples are examples of why our customers continue to trust our designs. The cast iron triple-eccentric counterbalanced drive is specifically designed to support high-speed applications and heavy workloads – the design has stood the test of time for over 70 years and continues to enable scientists today. The simple user interface allows for easy programming of speed, temperature, time and the VisioNize box can be added to enhance monitoring and adds notifications functionality. Regular servicing can be carried out in-situ, allowing for minimized downtime.



Product features

- > Console style shaker/incubator with triple-eccentric drive – provides large capacity shaking for flasks up to 6 L
- > Continuous mode or multiple-step programming
- > Programmable Innova controls – automatically changes temperature, speed, and optional photosynthetic and UV germicidal lights at timed intervals (Store up to 4 individual programs with 15 steps each)
- > Top mounted controls and display – for easy, ergonomic viewing and setting
- > Foot pedal release with easy to opening lid – provides hands-free door opening/closing operation and effortless access to samples
- > Built in spill pan catches accidental spills to aid cleaning and protects drive mechanism. Also allows use as a water reservoir to reduce sample evaporation

Ordering information

Description	Order no.
New Brunswick™ Innova® 43	
230 V, orbit diameter 2.5 cm (1 in)	M1320-0002
230 V, orbit diameter 5.1 cm (2 in)	M1320-0012
New Brunswick™ Innova® 43R	
230 V, orbit diameter 2.5 cm (1 in)	M1320-0006
230 V, orbit diameter 5.1 cm (2 in)	M1320-0016
Photosynthetic light bank , for Innova® 43R only, orbit diameter 2.5/5.1 cm (1/2 in)	M1320-0300
UV germicidal light , in the airflow path outside the chamber reduces the bio-burden of circulated air, Innova® 43R only, orbit diameter 2.5/5.1 cm (1/2 in)	M1320-0400
12-port gassing manifold , permits direct gassing into flasks, orbit diameter 2.5/5.1 cm (1/2 in)	M1320-0500
Humidity monitor , orbit diameter 2.5/5.1 cm (1/2 in)	M1320-0600
Remote alarm option , for Innova® 44/44, Innova® 43/43, Innova® 42/42 or Innova® 40/40	M1320-8029
Platforms for Innova® 2300/43/43R, Excella® E10/E25/E25R , 76 × 46 cm, aluminum	
Universal platform, aluminum	M1250-9920
50 mL Erlenmeyer flask dedicated platform	M1191-9908
125 mL Erlenmeyer flask dedicated platform	M1191-9909
250 mL Erlenmeyer flask dedicated platform	M1191-9910
500 mL Erlenmeyer flask dedicated platform	M1191-9911
1 L Erlenmeyer flask dedicated platform	AG-1
2 L Erlenmeyer flask dedicated platform	AG-2
Sticky pad platform, sticky pads sold separately, anodized Aluminum	M1250-9904
Utility tray , with non-skid rubber surface	AG-00

✎ Ordering information for other voltage options begins on page 450

New Brunswick™ Innova® 42/42R

Description

The Innova 42 and 42R (refrigerated) shakers are our most versatile incubator shakers in terms of placement and options. They can be stacked up to two units high and can also be placed on or under a standard height laboratory bench. In every scenario, the side opening door/s allow users access right up to the chamber. Options include a static culture drawer, gassing manifold, remote alarm, and humidity monitor and drip pan. Additionally, a photosynthetic light bank and UV germicidal light are available for the 42R.

The cast iron triple-eccentric counterbalanced drive is specifically designed to support high-speed applications and heavy workloads – the design has stood the test of time for over 70 years and continues to enable scientists today. The simple user interface allows for easy programming of speed, temperature, time and when installed, the photosynthetic light bank. The VisioNize box can be added to enhance monitoring and adds notifications functionality. Regular servicing can be carried out in-situ, allowing for minimized downtime.



Product features

- > Continuous, timed or Multi-step programming
- > Programmable Innova controls automatically changes temperature, speed, and optional photosynthetic and UV germicidal lights at timed intervals (Storage up to 4 individual programs with each 15 steps)
- > Large viewing window and internal light provide easy viewing of samples without the need to open the door
- > Integrated sub platforms diverts spills away from drive
- > Built in spill pan catches accidental spills to aid cleaning and protects drive mechanism. Also allows use as a water reservoir to reduce sample evaporation
- > Platforms (sold separately) accommodates flasks up to 6 L (configuration dependant) as well as test tube racks and microplate holders
- > One height adjustable static shelf included. Optional culture drawer sold separately (allowing reduced sample desiccation)

Ordering information

Description	Order no.
New Brunswick™ Innova® 42	
230 V, orbit diameter 1.9 cm (0.75 in)	M1335-0002
230 V, orbit diameter 2.5 cm (1 in)	M1335-0012
New Brunswick™ Innova® 42R	
230 V, orbit diameter 1.9 cm (0.75 in)	M1335-0006
230 V, orbit diameter 2.5 cm (1 in)	M1335-0016
Stacking kit , for stacking Innova® 42/42R units	M1335-0800
Stacking kit , for stacking Innova® 4200/4230 units on top of Innova® 42/42R shakers	M1335-0810
Photosynthetic light bank , programmable, Innova® 42R only, orbit diameter 1.9/2.5 cm (0.75/1 in)	M1335-0300
UV germicidal light , programmable, Innova® 42R only, orbit diameter 1.9/2.5 cm (0.75/1 in)	M1335-0400
Humidity monitor , for Innova® 42/42R, orbit diameter 1.9/2.5 cm (0.75/1 in)	M1335-0500
12-port gassing manifold , for Innova® 42/42R, orbit diameter 1.9/2.5 cm (0.75/1 in)	M1335-0600
Remote alarm option , for Innova® 44/44, Innova® 43/43, Innova® 42/42 or Innova® 40/40	M1320-8029
Additional perforated shelf and brackets , for Innova® 42/42R	M1335-0080
Platforms for Innova® 2100/40/40R/42/42R, Excella® E24/E24R , 45.7 × 45.7 cm, phenolic resin (unless otherwise stated)	
Universal platform, aluminum	M1250-9902
Drip pan , to catch accidental spills, for universal platform M1250-9902	M1250-9906
50 mL Erlenmeyer flask dedicated platform	M1194-9903
125 mL Erlenmeyer flask dedicated platform	M1194-9904
250 mL Erlenmeyer flask dedicated platform	M1194-9905
500 mL Erlenmeyer flask dedicated platform	M1194-9906
1 L Erlenmeyer flask dedicated platform	M1194-9907
2 L Erlenmeyer flask dedicated platform	M1194-9908
Sticky pad platform, sticky pads sold separately – anodized Aluminum	M1250-9903
Quick-change platform kit , enables platform attachment without tools	M1192-9901
Culture drawer , (height adjustable) prevents plates from drying	M1335-0501
Utility carrier , holds racks and vessels between x2 rubber-cushioned cross bars ¹⁾	M1194-9909
Rod kit , for utility carrier (one additional rod)	M1194-9923
Utility tray , with non-skid rubber surface ¹⁾	M1194-9910

¹⁾ Please order Utility carrier, Utility tray, Rod kit

✂ Ordering information for other voltage options begins on page 450

Technical specifications subject to change.

New Brunswick™ Innova® 40/40R

Description

The Innova 40 and 40R (refrigerated) benchtop shakers provide years of dependable operation. This is the perfect shaker to begin working on small-scale projects with a view to increase volume or throughput. The self-supporting transparent lid allows samples to be in view all the time. The ability to shake flasks up to 3 L in such a compact benchtop unit provides clear scope to upscale and options include a drip pan and remote alarm. The simple user interface allows for easy programming of speed, temperature, time. The VisioNize box can be added to enhance monitoring and adds notifications functionality. Regular servicing can be carried out in-situ, allowing for minimized downtime.



Product features

- > Triple-eccentric counterbalanced drive in cast iron housing provides vibration and trouble-free operation for years
- > Compact benchtop model – fits easily on the bench and holds flasks up to 3 L
- > Clear cover allows easy viewing of the cultures and lifts easily to access all samples
- > Versatile accessory platform (sold separately) accommodates flasks up to 3 L as well as test tube racks and microplate holders
- > Certified. Meets cETL, UL, CSA and CE standards

Ordering information

Description	Order no.
New Brunswick™ Innova® 40	
230 V, orbit diameter 1.9 cm (0.75 in)	M1299-0082
230 V, orbit diameter 2.5 cm (1 in)	M1299-0092
New Brunswick™ Innova® 40R	
230 V, orbit diameter 1.9 cm (0.75 in)	M1299-0086
230 V, orbit diameter 2.5 cm (1 in)	M1299-0096
Remote alarm option , for Innova® 44/44, Innova® 43/43, Innova® 42/42 or Innova® 40/40	M1320-8029
Drip pan , to catch accidental spills, for universal platform M1250-9902	M1250-9906
Platforms for Innova® 2100/40/40R/42/42R, Excella® E24/E24R , 45.7 × 45.7 cm, phenolic resin (unless otherwise stated)	
Universal platform, aluminum	M1250-9902
50 mL Erlenmeyer flask dedicated platform	M1194-9903
125 mL Erlenmeyer flask dedicated platform	M1194-9904
250 mL Erlenmeyer flask dedicated platform	M1194-9905
500 mL Erlenmeyer flask dedicated platform	M1194-9906
1 L Erlenmeyer flask dedicated platform	M1194-9907
2 L Erlenmeyer flask dedicated platform	M1194-9908
Sticky pad platform, sticky pads sold separately – anodized Aluminum	M1250-9903
Quick-change platform kit , enables platform attachment without tools	M1192-9901
Utility carrier , holds racks and vessels between x2 rubber-cushioned cross bars ¹⁾	M1194-9909
Rod kit , for utility carrier (one additional rod)	M1194-9923
Utility tray , with non-skid rubber surface ¹⁾	M1194-9910

¹⁾ Please order Utility carrier, Utility tray, Rod kit

✂ Ordering information for other voltage options begins on page 450

Your local distributor: www.eppendorf.com/contact

Eppendorf AG · Barkhausenweg 1 · 22339 Hamburg · Germany · eppendorf@eppendorf.com · www.eppendorf.com · www.eppendorf.com/eshop

New Brunswick™ Excella® E25/E25R

Description

The Excella E25 and E25R (refrigerated) shakers accommodate flasks up to 6 L in volume. A large viewing window allows you to keep an eye on your samples without opening the lid. A wide variety of platforms, clamps and test tube racks provide for a number of different workstreams. The E25 and E25R are complemented by Eppendorf's service offering, ranging from preventative maintenance through to parameter calibration.



Product features

- > Heavy-duty counterbalanced drive provides long life, vibration-free, quiet and dependable operation
- > Large platform size provides increased flexibility with the number and size of cultures (sold separately)
- > Large viewing window and internal light – for easy viewing of samples without the need to open the door
- > Microprocessor controls precisely regulate temperature, speed and running time
- > Audible and visual alarms alert you to setpoint deviations or end of study
- > Powerful fan and heater provide rapid heat up and temperature recovery after door opening

Ordering information

Description	Order no.
New Brunswick™ Excella® E25 , 230 V, orbit diameter 2.5 cm (1 in)	M1353-0002
New Brunswick™ Excella® E25R , 230 V, orbit diameter 2.5 cm (1 in)	M1353-0006
Platforms for Innova® 2300/43/43R, Excella® E10/E25/E25R , 76 × 46 cm, aluminum	
Universal platform, aluminum	M1250-9920
50 mL Erlenmeyer flask dedicated platform	M1191-9908
125 mL Erlenmeyer flask dedicated platform	M1191-9909
250 mL Erlenmeyer flask dedicated platform	M1191-9910
500 mL Erlenmeyer flask dedicated platform	M1191-9911
1 L Erlenmeyer flask dedicated platform	AG-1
2 L Erlenmeyer flask dedicated platform	AG-2
Sticky pad platform, sticky pads sold separately, anodized Aluminum	M1250-9904
Utility tray , with non-skid rubber surface	AG-00

✂ Ordering information for other voltage options begins on page 450

New Brunswick™ Excella® E24/E24R

Description

The benchtop Excella E24 and E24R (refrigerated) shakers accommodate flasks up to 2.8 L in volume. The acrylic lid provides excellent visibility of your samples. A wide variety of platforms, clamps and test tube racks provide for a number of different workstreams. The E24 and E24R are complemented by Eppendorf's service offering, ranging from preventative maintenance through to parameter calibration.



Product features

- > Heavy-duty unicentric counterbalanced drive provides long life, vibration-free, quiet, and dependable operation
- > Versatile accessory platform (sold separately) accommodates flasks up to 2.8 L as well as test tube racks and microplate holders
- > User-friendly keypad with simple LED display is clearly visible and easy to use
- > Clear large lid provides excellent visibility minimizing the need to open the lid
- > Audible and visual alarms alert you to setpoint deviations or end of study
- > Acceleration/deceleration circuit prevents sudden starts and stops protecting your cells
- > Microprocessor controls precisely regulate temperature, speed and running time

Ordering information

Description	Order no.
New Brunswick™ Excella® E24 230 V, orbit diameter 1.9 cm (0.75 in)	M1352-0002
New Brunswick™ Excella® E24R 230 V, orbit diameter 1.9 cm (0.75 in)	M1352-0006
Drip pan , to catch accidental spills, for universal platform M1250-9902	M1250-9906
Platforms for Innova® 2100/40/40R/42/42R, Excella® E24/E24R , 45.7 × 45.7 cm, phenolic resin (unless otherwise stated)	
Universal platform, aluminum	M1250-9902
50 mL Erlenmeyer flask dedicated platform	M1194-9903
125 mL Erlenmeyer flask dedicated platform	M1194-9904
250 mL Erlenmeyer flask dedicated platform	M1194-9905
500 mL Erlenmeyer flask dedicated platform	M1194-9906
1 L Erlenmeyer flask dedicated platform	M1194-9907
2 L Erlenmeyer flask dedicated platform	M1194-9908
Sticky pad platform, sticky pads sold separately – anodized Aluminum	M1250-9903
Quick-change platform kit , enables platform attachment without tools	M1192-9901
Utility carrier , holds racks and vessels between x2 rubber-cushioned cross bars ¹⁾	M1194-9909
Rod kit , for utility carrier (one additional rod)	M1194-9923
Utility tray , with non-skid rubber surface ¹⁾	M1194-9910

¹⁾ Please order Utility carrier, Utility tray, Rod kit

✂ Ordering information for other voltage options begins on page 450

Open Air Shakers

Description

The New Brunswick open air shakers specifically designed be used at full capacity in a 24/7 environment. A wide variety of platforms, clamps and test tube racks provide for a number of different workstreams. The cast iron triple-eccentric counterbalanced drive is specifically designed to support high-speed applications and heavy workloads – the design has stood the test of time for over 70 years and continues to enable scientists today.



Product features

- > Triple-eccentric counterbalanced drive in cast iron housing provides vibration and trouble-free operation for years
- > Quiet operation provides a favorable work environment
- > Shaking speeds between 25 – 500 rpm (± 1 rpm) provide versatility for culturing a wide range of cell types
- > Simple, easy to use LED display
- > Timed or continuous shaking
- > Speed controlled and displayed in increments of 1 rpm
- > Includes audible and visual alarms, timer (0 – 99.9 h) with continuous operation or automatic shut-off at the end of the study
- > Enclosed electronics and mechanical components prevent internal damage from accidental spills
- > Versatile 33 x 28 cm (13 x 11 in) accessory platform (sold separately) accommodates flasks up to 500 mL
- > Low profile – less than 6" (15 cm) tall-enables use of multiple shakers in an environmental chamber

For more information go to www.eppendorf.com

Technical specifications subject to change.

New Brunswick™ Innova® 2350



Ordering information

Description	Order no.
New Brunswick™ Innova® 2350 , platform sold separately	
220/230 V, orbit diameter 2.5 cm (1 in)	M1191-0012
220/230 V, orbit diameter 5.1 cm (2 in)	M1191-0032
Interchangeable platform for Innova® 2350 , 91.4 x 61 cm, marine plywood unless otherwise noted	
Universal platform, aluminum	PTL-393
125 mL Erlenmeyer flask dedicated platform	M1191-9912
250 mL Erlenmeyer flask dedicated platform	M1191-9913
500 mL Erlenmeyer flask dedicated platform	M1191-9914
Utility tray , with non-skid rubber surface	AG-21-00
Temperature and speed monitoring kit , for recording on an external chart recorder for Innova® 2100/2150/2300/2350	M1194-9924

Ordering information for other voltage options begins on page 450

New Brunswick™ Innova® 2300



Ordering information

Description	Order no.
New Brunswick™ Innova® 2300 , platform sold separately	
220/230 V, orbit diameter 2.5 cm (1 in)	M1191-0002
220/230 V, orbit diameter 5.1 cm (2 in)	M1191-0022
Drip pan , to catch accidental spills, for use with universal platform M1250-9920	M1250-9921
Platforms for Innova® 2300/43/43R, Excella® E10/E25/E25R , 76 x 46 cm, aluminum	
Universal platform, aluminum	M1250-9920
50 mL Erlenmeyer flask dedicated platform	M1191-9908
125 mL Erlenmeyer flask dedicated platform	M1191-9909
250 mL Erlenmeyer flask dedicated platform	M1191-9910
500 mL Erlenmeyer flask dedicated platform	M1191-9911
1 L Erlenmeyer flask dedicated platform	AG-1
2 L Erlenmeyer flask dedicated platform	AG-2
Sticky pad platform, sticky pads sold separately, anodized Aluminum	M1250-9904
Utility tray , with non-skid rubber surface	AG-00
Quick-change platform kit , enables platform attachment without tools	M1191-9904
Capacity upgrade kit , to convert a Model 2300 to a Model 2350	M1191-9905
Temperature and speed monitoring kit , for recording on an external chart recorder for Innova® 2100/2150/2300/2350	M1194-9924

Ordering information for other voltage options begins on page 450

Your local distributor: www.eppendorf.com/contact

Eppendorf AG · Barkhausenweg 1 · 22339 Hamburg · Germany · eppendorf@eppendorf.com · www.eppendorf.com · www.eppendorf.com/eshop

New Brunswick™ Innova® 2150



Ordering information	
Description	Order no.
New Brunswick™ Innova® 2150 , platform sold separately, 220/230 V, orbit diameter 1.9 cm (0.75 in)	M1194-0012
Interchangeable platform for Innova® 2150 , 61 x 45.7 cm, phenolic resin	
Universal platform	M1194-9912
1 L Erlenmeyer flask dedicated platform	M1194-9919
2 L Erlenmeyer flask dedicated platform	M1194-9920
Utility carrier , holds glassware between rubber-cushioned cross bars	M1194-9921
Rod kit , for utility carrier (one additional rod)	M1194-9925
Utility tray , with non-skid rubber surface	M1194-9922
Quick-change platform kit , enables platform attachment without tools	M1194-9927
Temperature and speed monitoring kit , for recording on an external chart recorder for Innova® 2100/2150/2300/2350	M1194-9924

✎ Ordering information for other voltage options begins on page 450

New Brunswick™ Innova® 2050



Ordering information	
Description	Order no.
New Brunswick™ Innova® 2050 , platform sold separately, 220/230 V, orbit diameter 1.9 cm (0.75 in)	M1190-0012
Platform for Innova® 2050 , 40.6 x 30.5 cm, stainless steel	
Universal platform	M1190-9900
25 mL Erlenmeyer flask dedicated platform	M1190-9902
50 mL Erlenmeyer flask dedicated platform	M1190-9903
125 mL Erlenmeyer flask dedicated platform	M1190-9904
250 mL Erlenmeyer flask dedicated platform	M1190-9905
500 mL Erlenmeyer flask dedicated platform	M1190-9906
1 L Erlenmeyer flask dedicated platform	M1190-9911
Utility carrier , holds glassware between rubber-cushioned cross bars	M1190-9907
Utility tray , with non-skid rubber surface	M1190-9908

✎ Ordering information for other voltage options begins on page 450

New Brunswick™ Innova® 2100



Ordering information	
Description	Order no.
New Brunswick™ Innova® 2100 , platform sold separately, 220/230 V, orbit diameter 1.9 cm (0.75 in)	M1194-0002
Platforms for Innova® 2100/40/40R/42/42R, Excella® E24/E24R , 45.7 x 45.7 cm, phenolic resin (unless otherwise stated)	
Universal platform, aluminum	M1250-9902
50 mL Erlenmeyer flask dedicated platform	M1194-9903
125 mL Erlenmeyer flask dedicated platform	M1194-9904
250 mL Erlenmeyer flask dedicated platform	M1194-9905
500 mL Erlenmeyer flask dedicated platform	M1194-9906
1 L Erlenmeyer flask dedicated platform	M1194-9907
2 L Erlenmeyer flask dedicated platform	M1194-9908
Sticky pad platform, sticky pads sold separately – anodized Aluminum	M1250-9903
Quick-change platform kit , enables platform attachment without tools	M1192-9901
Utility carrier , holds racks and vessels between x2 rubber-cushioned cross bars ¹⁾	M1194-9909
Rod kit , for utility carrier (one additional rod)	M1194-9923
Utility tray , with non-skid rubber surface ¹⁾	M1194-9910
Capacity upgrade kit , to convert a Model 2100 to a Model 2150	M1194-9926
Drip pan , to catch accidental spills, for universal platform M1250-9902	M1250-9906
Temperature and speed monitoring kit , for recording on an external chart recorder for Innova® 2100/2150/2300/2350	M1194-9924

¹⁾ Please order Utility carrier, Utility tray, Rod kit

✎ Ordering information for other voltage options begins on page 450

New Brunswick™ Innova® 2000



Ordering information	
Description	Order no.
New Brunswick™ Innova® 2000 , platform sold separately, 220/230 V, orbit diameter 1.9 cm (0.75 in)	M1190-0002
Platform for Innova® 2000 , 33 x 28 cm, stainless steel	
Universal platform	M1001-0240
25 mL Erlenmeyer flask dedicated platform	M1190-9919
50 mL Erlenmeyer flask dedicated platform	M1190-9915
125 mL Erlenmeyer flask dedicated platform	M1190-9916
250 mL Erlenmeyer flask dedicated platform	M1190-9917
500 mL Erlenmeyer flask dedicated platform	M1190-9918
Utility carrier , holds glassware between rubber-cushioned cross bars	AG2-UT
Utility tray , with non-skid rubber surface	AG2-00
Rod kit , for utility carrier (one additional rod)	M1001-9920
Capacity upgrade kit , to convert a Model 2000 to a Model 2050	M1190-9910
Temperature and speed monitoring kit , for recording on an external chart recorder	M1190-9909

✎ Ordering information for other voltage options begins on page 450

New Brunswick™ Innova® 5050/5051 Racking Systems



Description

Save space and stack Innova 2300 open air shakers. Model 5050 consists of a sturdy, stainless-steel rack to hold up to 4 Innova 2300 shakers. Innova 5051 rack extension can be added to support an additional 4 shakers, bringing the total number to 8 Innova 2300 shakers.

Product features

- > Includes electrical strip for power multiple shakers
- > Maximum speed 400 rpm for 2.5 cm (1 in) orbits and 300 rpm for 5.1 cm (2 in) orbits
- > Larger flasks can be accommodated by removing adjustable-height shelves
- > Comes pre-assembled

Ordering information

Description	Order no.
New Brunswick™ Innova® 5050 Rack System, 230/240 V	M1232-0101
New Brunswick™ Innova® 5051 Rack Extension, 230/240 V	M1232-0111

Clamps and Accessories for Universal Platforms



Dedicated platforms come with clamps of one size pre-installed.



Flask clamp, of one-piece stainless steel, fitted with springs for stability at elevated speeds.

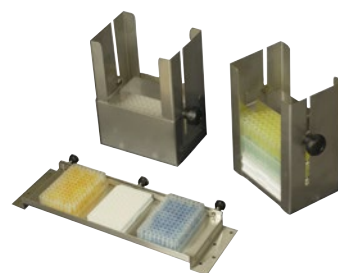

Microplate racks and carriers mount to any universal platform and are used to secure microplates. Racks can either be ordered for stacking the plates or laying plates flat in a single layer.



Test tube racks, small, medium and large.



Utility carries secure vessels between adjustable, cushioned rods.



Universal platform shown with accessory clamps, test tube racks and sticky tape.

For more information go to www.eppendorf.com

Technical specifications subject to change.

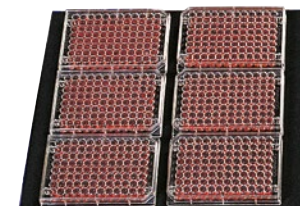

Utility trays provide a non-slip surface for low-speed applications.

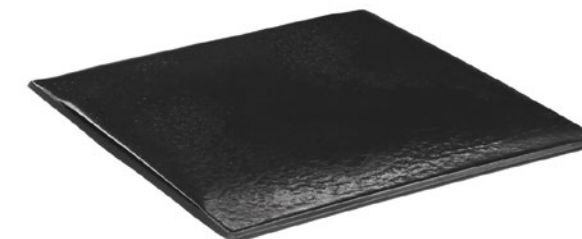

Sticky pad (shown) and sticky tape replace clamps for speeds up to 250 rpm. Sticky pad requires an anodized aluminum surface.

Accessories

Description	Order no.
Test tube rack, small, 30.0 × 8.0 × 12.9 cm	
diameter 8 – 11 mm, 48 tubes	M1289-0001
diameter 12 – 15 mm, 34 tubes	M1289-0002
diameter 15 – 18 mm, 24 tubes	M1289-0003
diameter 18 – 21 mm, 18 tubes	M1289-0004
diameter 22 – 26 mm, 13 tubes	M1289-0005
diameter 26 – 30 mm, 12 tubes	M1289-0006
Test tube rack, medium, 36 × 8 × 12.9 cm	
diameter 8 – 11 mm, 60 tubes	M1289-0010
diameter 12 – 15 mm, 44 tubes	M1289-0020
diameter 15 – 18 mm, 31 tubes	M1289-0030
diameter 18 – 21 mm, 23 tubes	M1289-0040
diameter 22 – 26 mm, 16 tubes	M1289-0050
diameter 26 – 30 mm, 16 tubes	M1289-0060
Test tube rack, large, 45 × 8 × 12.9 cm	
diameter 8 – 11 mm, 80 tubes	M1289-0100
diameter 12 – 15 mm, 60 tubes	M1289-0200
diameter 15 – 18 mm, 42 tubes	M1289-0300
diameter 18 – 21 mm, 30 tubes	M1289-0400
diameter 22 – 26 mm, 22 tubes	M1289-0500
diameter 26 – 30 mm, 20 tubes	M1289-0600
Clamp, for 1 L media bottles	ACSB-1000S
Clamp, for 500 mL media bottles	ACSB-500S
Angled test tube rack holder, for user-supplied test tube racks and microplates	TTR-210
Spacer bar for TTR-210	TTR-215
Microplate rack, single layer, for single layer of five plates	TTR-221
Microplate rack, stack, stack three deepwell or nine standard plates	M1289-0700
Sticky pad adapter kit, 2 anodized aluminum sheets, each 15.2 × 45.7 cm (6 × 18 in)	M1250-9504
Sticky tape, 23 × 3.8 cm (75 feet × 1.5 in) roll	M1250-9600
Sticky pad, 20 × 20 cm (8 × 8 in)	M1250-9700
Drip pan, to catch accidental spills, for use with universal platform M1250-9920	M1250-9921
Drip pan, to catch accidental spills, for universal platform M1250-9902	M1250-9906

8 – 11 mm: fits e.g. Eppendorf tubes 1.5 mL

15 – 18 mm: fits e.g. 15 mL Conicals

26 – 30 mm: fits e.g. 50 mL Conicals

Your local distributor: www.eppendorf.com/contact

Eppendorf AG · Barkhausenweg 1 · 22339 Hamburg · Germany · eppendorf@eppendorf.com · www.eppendorf.com · www.eppendorf.com/eshop

Universal Platforms and Clamps for Incubated Shakers

Universal Platforms and Clamps for Incubated Shakers

	Innova® S44i	Innova® 44/44R	Innova® 43/43R	Innova® 42/42R
Platforms for Shakers	M1250-9920	M1282-9904	M1250-9920	M1250-9902
	Clamps	Clamps	Clamps	Clamps
10 mL Erlenmeyer flasks	238	187	183	109
25 mL Erlenmeyer flasks	238	93	92	64
50 mL Erlenmeyer flasks	130	91	92	45
125 mL Erlenmeyer flasks	81	39	39	21
250 mL Erlenmeyer flasks	49	30	30	18
500 mL Erlenmeyer flasks	36	24	18	14
1 L Erlenmeyer flasks	20	14	12	8
2 L Erlenmeyer flasks	13	8	8	5
2 L Lauber Thompson	13	8	8	5
2.8 L Fernbach flasks	8	6	6	4
3 L Erlenmeyer flasks	8	6	6	4
4 L Erlenmeyer flasks	8	6	6	4
5 L Erlenmeyer flasks	6 ¹⁾	6 ²⁾	6 ²⁾	4 ¹⁾
6 L Erlenmeyer flasks			4	2
500 mL media bottle flasks	20	18	19	9
1 L media bottle flasks	20	13	13	8
Microplate rack, single layer	4	4	4	2
Microplate rack, stack	20	16	16	8
Test tube rack, small, 30 × 8 × 12.9 cm	12	9	9	5
Test tube rack, medium, 36 × 8 × 12.9 cm	10	9	9	5
Test tube rack, large, 45 × 8 × 12.9 cm	8	7	7	4
Platform size	76 × 62 cm (30 × 24 in)	76 × 46 cm (30 × 18 in)	76 × 46 cm (30 × 18 in)	46 × 46 cm (18 × 18 in)

ACE-2002 does not fit narrow-neck Erlenmeyer according to DIN ISO 1773, please use M1190-9005 instead

¹⁾ Max. flask size 4 L with photosynthetic light bank, shelf or drawer installed. Shelf and drawer are easily removable ²⁾ Max. flask size 4 L with photosynthetic light bank installed

Dedicated Platforms and Clamps for Incubated Shakers

	Innova® S44i		Innova® 44/44R		Innova® 43/43R	
	Clamps	Order no.	Clamps	Order no.	Clamps	Order no.
50 mL Erlenmeyer flasks					108	M1191-9908
125 mL Erlenmeyer flasks	86	S44I040002	60	M1282-9905	60	M1191-9909
250 mL Erlenmeyer flasks	53	S44I040003	40	M1282-9906	40	M1191-9910
500 mL Erlenmeyer flasks	39	S44I040004	24	M1282-9907	24	M1191-9911
1 L Erlenmeyer flasks	23	S44I040005	15	M1282-9908	15	AG-1
2 L Erlenmeyer flasks	15	S44I040006	12	M1282-9909	12	AG-2
Sticky pad platform			M1282-9913		M1250-9904	
Platform size	76 × 62 cm (30 × 24 in)		76 × 46 cm (30 × 18 in)		76 × 46 cm (30 × 18 in)	

The S44i Universal platform is designed to be compatible with sticky pads

ACE-2002 does not fit narrow-neck Erlenmeyer according to DIN ISO 1773, please use M1190-9005 instead

Sticky pads to be ordered separately see page 351

For more information go to www.eppendorf.com

Innova® 40/40R	Excella® E25/E25R	Excella® E24/E24R	Clamps	Clamps
M1250-9902	M1250-9920	M1250-9902		
Clamps	Clamps	Clamps	Dimensions (W × H)	Order no.
109	183	109	31 × 26 mm	ACE-10S
64	92	64	38 × 21 mm	M1190-9004
45	92	45	51 × 26 mm	M1190-9000
21	39	21	66 × 36 mm	M1190-9001
18	30	18	79 × 48 mm	M1190-9002
14	18	14	100 × 52 mm	M1190-9003
8	12	8	120 × 63 mm	ACE-1000S
5	8	5	152 × 71 mm	ACE-2000S
5	8	5	168 × 112 mm	M1190-9005
4	6	4	198 × 66 mm	ACFE-2800S
4	6	4	189 × 128 mm	ACE-3000S
	6		196 × 95 mm	ACE-4000S
	6 ²⁾		222 × 145 mm	ACE-5000S
	4		225 × 96 mm	ACE-6000S
9	19	9	110 × 108 mm	ACSB-500S
8	13	8	129 × 146 mm	ACSB-1000S
2	4	2		TTR-221
8	16	8		M1289-0700
5	9	5		see page 350
5	9	5		see page 350
4	7	4		see page 350
46 × 46 cm (18 × 18 in)	76 × 46 cm (30 × 18 in)	46 × 46 cm (18 × 18 in)		

Innova® 42/42R		Innova® 40/40R		Excella® E25/E25R		Excella® E24/E24R		Clamps
Clamps	Order no.	Clamps	Order no.	Clamps	Order no.	Clamps	Order no.	Dimensions (W × H)
64	M1194-9903	64	M1194-9903	108	M1191-9908	64	M1194-9903	51 × 26 mm
34	M1194-9904	34	M1194-9904	60	M1191-9909	34	M1194-9904	66 × 36 mm
25	M1194-9905	25	M1194-9905	40	M1191-9910	25	M1194-9905	79 × 48 mm
16	M1194-9906	16	M1194-9906	24	M1191-9911	16	M1194-9906	100 × 52 mm
9	M1194-9907	9	M1194-9907	15	AG-1	9	M1194-9907	120 × 63 mm
5	M1194-9908	5	M1194-9908	12	AG-2	5	M1194-9908	152 × 71 mm
	M1250-9903		M1250-9903		M1250-9904		M1250-9903	
46 × 46 cm (18 × 18 in)		46 × 46 cm (18 × 18 in)		76 × 46 cm (30 × 18 in)		46 × 46 cm (18 × 18 in)		

Universal Platforms and Clamps for Innova® Open Air Shakers

Universal Platforms and Clamps for Innova® Open Air Shakers

	Innova® 2350	Innova® 2300	Innova® 2150	Innova® 2100
Platforms for Shakers	PTL-386	M1250-9920	M1194-9912	M1250-9902
	Clamps	Clamps	Clamps	Clamps
10 mL Erlenmeyer flasks		183		109
25 mL Erlenmeyer flasks		92		64
50 mL Erlenmeyer flasks		92	63	45
125 mL Erlenmeyer flasks	75	39	35	21
250 mL Erlenmeyer flasks	50	30	24	18
500 mL Erlenmeyer flasks	30	18	20	14
1 L Erlenmeyer flasks	24	12	12	8
2 L Erlenmeyer flasks	15	8	6	5
2 L Lauber Thompson	12	6	5	4
2.8 L Fernbach flasks	12	6	5	4
3 L Erlenmeyer flasks	11	6	5	4
4 L Erlenmeyer flasks	11	6	5	4
5 L Erlenmeyer flasks	8	6	4	
6 L Erlenmeyer flasks	7	4	3	2
500 mL media bottle flasks	35	19	15	9
1 L media bottle flasks	23	13	11	8
Microplate rack, stack	16	16	16	8
Microplate rack, single layer	4	4	4	2
Test tube rack, small, 30 × 8 × 12.9 cm	18	9	9	5
Test tube rack, medium, 36 × 8 × 12.9 cm	13	9	9	5
Test tube rack, large, 45 × 8 × 12.9 cm	12	7	7	4
Platform size	91 × 61 cm (36 × 24 in)	76 × 46 cm (30 × 18 in)	61 × 46 cm (24 × 18 in)	46 × 46 cm (18 × 18 in)

ACE-2002 does not fit narrow-neck Erlenmeyer according to DIN ISO 1773, please use M1190-9005 instead

Dedicated Platforms and Clamps for Innova Open Air Shakers

	Innova® 2350		Innova® 2300		Innova® 2150	
	Clamps	Order no.	Clamps	Order no.	Clamps	Order no.
25 mL Erlenmeyer flasks						
50 mL Erlenmeyer flasks			108	M1191-9908	80	M1194-9915
125 mL Erlenmeyer flasks	96	M1191-9912	60	M1191-9909	48	M1194-9916
250 mL Erlenmeyer flasks	70	M1191-9913	40	M1191-9910	35	M1194-9917
500 mL Erlenmeyer flasks	40	M1191-9914	24	M1191-9911	20	M1194-9918
1 L Erlenmeyer flasks			15	AG-1	12	M1194-9919
2 L Erlenmeyer flasks			12	AG-2	8	M1194-9920
Sticky pad platform				M1250-9904		
Platform size	91 × 61 cm (36 × 24 in)		76 × 46 cm (30 × 18 in)		61 × 46 cm (24 × 18 in)	

ACE-2002 does not fit narrow-neck Erlenmeyer according to DIN ISO 1773, please use M1190-9005 instead

Sticky pads to be ordered separately see page 351

For more information go to www.eppendorf.com

Innova® 2050	Innova® 2000	Clamps	Clamps
M1190-9900	M1001-0240		
Clamps	Clamps	Dimensions (W × H)	Order no.
86	60	31 × 26 mm	ACE-10S
32	20	38 × 21 mm	M1190-9004
32	15	51 × 26 mm	M1190-9000
16	11	66 × 36 mm	M1190-9001
10	6	79 × 48 mm	M1190-9002
8	4	100 × 52 mm	M1190-9003
		120 × 63 mm	ACE-1000S
		152 × 71 mm	ACE-2000S
		168 × 112 mm	M1190-9005
		198 × 66 mm	ACFE-2800S
		189 × 128 mm	ACE-3000S
		196 × 95 mm	ACE-4000S
		222 × 145 mm	ACE-5000S
		225 × 96 mm	ACE-6000S
6	4	110 × 108 mm	ACSB-500S
4		129 × 146 mm	ACSB-1000S
			M1289-0700
			TTR-221
4	3		see page 350
3			see page 350
			see page 350
41 × 31 cm (16 × 12 in)	33 × 28 cm (13 × 11 in)		

Innova® 2100		Innova® 2050		Innova® 2000		Clamps
Clamps	Order no.	Clamps	Order no.	Clamps	Order no.	Dimensions (W × H)
		48	M1190-9902	32	M1190-9919	38 × 21 mm
64	M1194-9903	35	M1190-9903	20	M1190-9915	51 × 26 mm
34	M1194-9904	20	M1190-9904	12	M1190-9916	66 × 36 mm
25	M1194-9905	12	M1190-9905	8	M1190-9917	79 × 48 mm
16	M1194-9906	8	M1190-9906	6	M1190-9918	100 × 52 mm
9	M1194-9907	6	M1190-9911			120 × 63 mm
5	M1194-9908					152 × 71 mm
	M1250-9903				M1190-0300	
46 × 46 cm (18 × 18 in)		41 × 31 cm (16 × 12 in)		33 × 28 cm (13 × 11 in)		



»Heal, fuel, and feed the World.«

Stephen Sherwin

Bioprocess engineers develop and produce a multitude of products and ingredients available today. Their applications are diverse, and the products can be found in pharmaceutical, chemical, and nutrition industries. Stephen Sherwin, former chairman of BIO association put it aptly: "Heal, fuel, and feed the world".

Our Eppendorf bioprocess solutions are successfully used in these industries and in applied research for decades. By exploiting the strong synergies in bioreactor technology and polymer manufacturing, Eppendorf has emerged as a global player and valuable resource to its customers. With an integrated portfolio comprising software, instruments, consumables, and services, we can satisfy the demands of bioprocess development through production. In that way and in line with our corporate mission, we contribute to the efforts of Eppendorf customers worldwide to improve human living conditions.

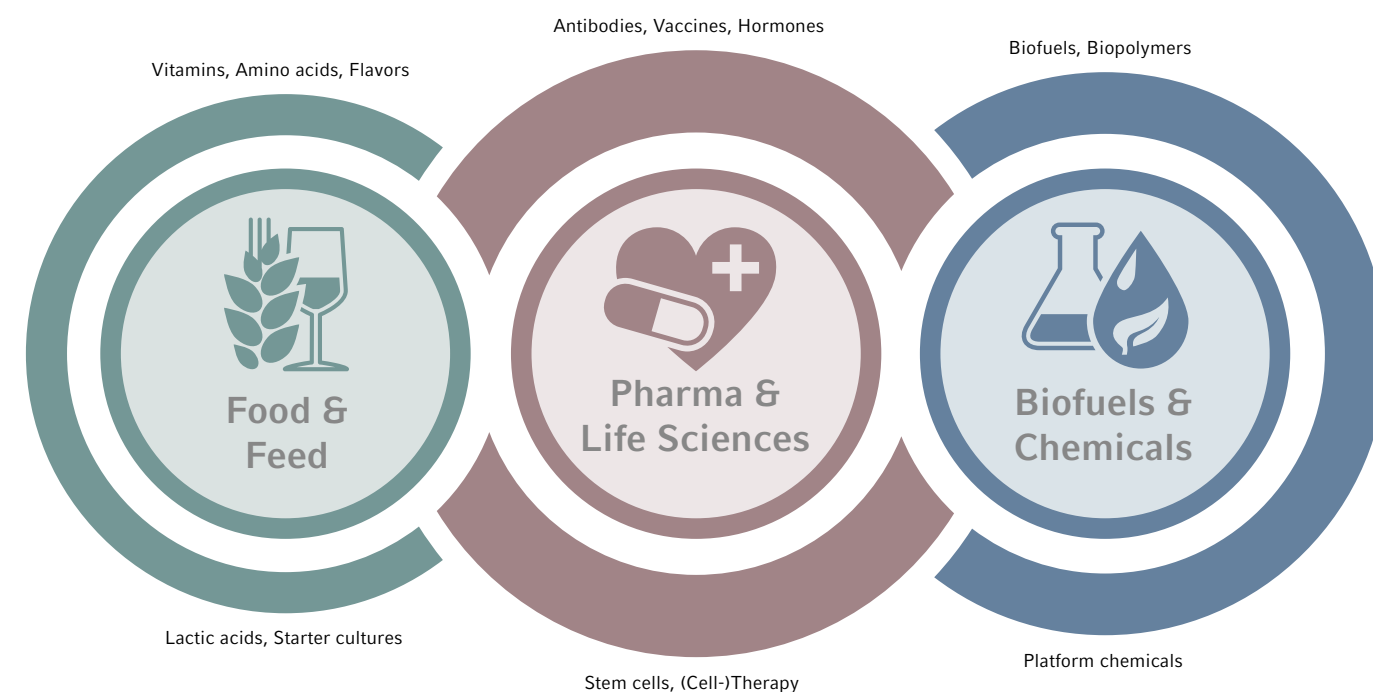

Addressing Our Customers' Challenges

Single-use equipment, automation, perfusion culture, and other techniques have the potential to increase efficiency and change the way scientists and engineers work. Along with process intensification comes the need to utilize resources wisely. Users have to cope with rising amounts of data in order to achieve their goals faster.

They are being appraised by process performance characteristics such as costs per run and turn-around times. Eppendorf is the right partner to meet these challenges. Satisfying professionals with full solutions to their tasks is what our bioprocess specialists are focussing on day-to-day. Expert teams take care of our customers worldwide.

»Our bioprocess customers expect a special kind of support. Not only do our employees need to know their way around the technical devices; a knowledge of biological applications is also required. After all, we can only help if we understand exactly what our customers do and need. And in many cases, this close contact also results in new solutions.«
Dr. Karl Rix, Vice President, Head of Business Unit Bioprocess, Eppendorf



Process and Manufacturing

The biopharmaceutical landscape has long been dominated by the production of recombinant proteins and monoclonal antibodies (mABs). Nowadays, the industry is moving towards more diverse pipelines with a broader variety of biological active pharmaceutical ingredients (APIs), including biosimilars. Reacting to these rising demands, companies put flexible systems in place, optimized to balance costs and time-to-market.

Eppendorf offers flexible bioprocess solutions from a single source, supporting batch, fed-batch, continuous, and perfusion cultivation. From parallel small-scale bioreactor systems for early stage bioprocess development, benchtop bioreactors and fermentors for the laboratory scale to sterilize-in-place products for technology transfer and scale-up to production. They enable bioprocess professionals to establish robust and reproducible processes in all scales.

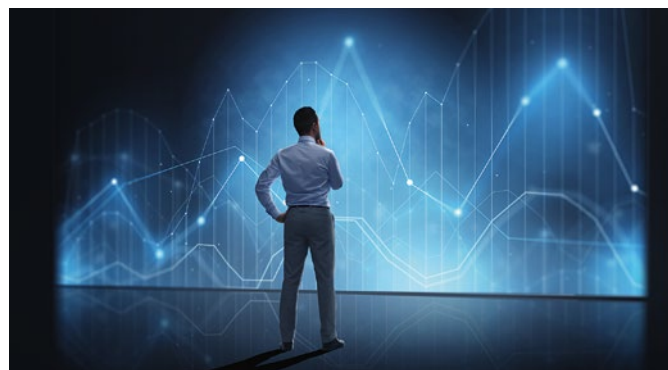

Control and Analytics

Monitoring and control is key in bioprocess development and ensures the process environment for optimum cell growth and high-titer production. Applying Process Analytical Technology (PAT) concepts provides real-time insights improving product quality. Predictive models of cell and process performance enhance process understanding and optimize control through forecasting and estimating optimum parameter settings. Statistical tools like Multivariate Data Analysis (MVA) help scientists to get the most out of their data.

Software solutions from Eppendorf make use of these techniques by providing more than just bioprocess control. Comprehensive data- and information management supports scientists in enhancing their development efforts.



Quality and Regulatory Aspects

The FDA's Quality by Design approach aims to design product quality and process efficiency into the process as early as possible. It includes the identification of critical process parameters (CPPs) and critical quality attributes (CQAs). These have to be monitored, controlled, and documented early in biopharmaceutical development. Process automation opens up new possibilities in terms of quality control and validation. Eppendorf's parallel small-scale bioreactor systems support customers in implementing Quality by Design (QbD) principles in the development phase. Our advanced bioprocess control software is 21 CFR Part 11 compatible. Single-use bioreactor solutions from Eppendorf help make laboratories more efficient and safe.



Integration and Services

Bioprocess equipment requires first-class service to achieve optimum results. Globalization, digital technologies, rising cost pressures, and the urge to be flexible in their operations make companies in the bioprocessing space face new challenges. They have to adapt their processes, facilities, and supply chains to these needs, establish global networks, and ensure high-quality training of all employees. At Eppendorf, we offer broad expertise in automation and integration of third-party devices, making sure your systems run efficiently and are seamlessly integrated. Eppendorf customers can rely on high-quality technical and application support as well as comprehensive training and technical documentation.

Vaccines

Driven by epidemic events and by governmental vaccination programs, there is a rising demand for development of new vaccines and the industry is growing at a double-digit rate. Eppendorf bioprocess equipment helps companies in setting up flexible processes that help balancing costs and shortening time-to-market. Learn more on www.eppendorf.com/vaccines

Antibodies/Hormones

Improved cultivation techniques such as perfusion and new possibilities in data handling and automation enhance development of antibodies, therapeutic proteins, and active ingredients. See how Eppendorf can support you with these initiatives on www.eppendorf.com/antibodies

Besides standard impellers, Eppendorf offers specialty impellers which can facilitate continuous and perfusion processes: Spin filters, Cell-Lift impellers, and packed-bed basket impellers.

Fibra-Cel® disks are a solid support material for growth of adherent mammalian, animal, and insect cells, when secreted proteins are desired.

Key advantages:

- > Cell densities averaging 10 times higher than traditional microcarriers, due to protection from shear forces
- > Higher mass transfer of nutrients and oxygen
- > Low pressure drop across the bed for efficient scale-up
- > Higher surface-to-volume ratios

Stem Cells

Stem cell-based technologies are promising approaches for therapy and drug discovery. For commercialization, researchers are evaluating standardization of their cultures and efficient scale-up. Eppendorf customers rely on our bioprocess solutions for controlled cultivation of induced pluripotent stem cells (iPSCs), mesenchymal stem cells (MSCs), and others.



Researchers at Ncardia®, Netherlands rely on the DASbox® Mini Bioreactor System to develop a process for scaling up their production of iPSC-derived cardiovascular cells. Find this and more research examples at www.eppendorf.com/stem-cell-bioprocessing

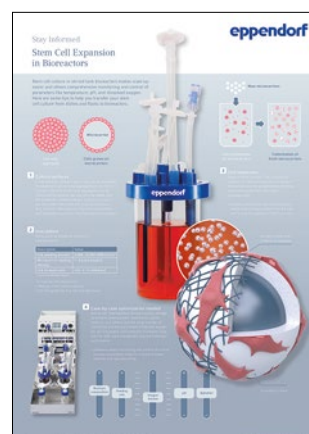

Food & Feed

Microorganisms are routinely used in the food and animal feed industries for processes such as alcohol fermentation, the acidification of dairy products or ensilage. Besides, bacteria and fungi are gaining popularity in the production of food additives such as vitamins, antioxidants or bioactive peptides.

Eppendorf fermentors are available in sizes ranging from 65 mL – 1,200 L and serve process engineers from research and process development through production:

- > Strain and process characterization
- > Scale-down
- > High-cell-density fermentation
- > Scale-up

Read how our customers at BIOMIN®, Evonik®, and others benefit from Eppendorf fermentation solutions:

www.eppendorf.com/food-feed



Chemicals

Chemical synthesis, with its use of partially toxic reagents and solvents as well as high energy consumption, is in direct conflict with the sustainable handling of energy and raw material resources. Meanwhile, a large variety of chemicals can be efficiently produced by microbial fermentation. They are used for example as building blocks for polymers, food supplements, and ingredients for cosmetics. Complex biopolymers have the potential to replace fossil-derived plastics in the future.

Learn more:

www.eppendorf.com/chemicals

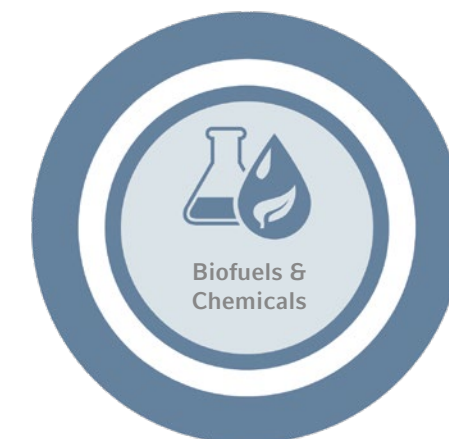

Academic Customers

No matter which area you are doing research in: We understand that universities and other publicly funded institutes are facing special challenges, such as frequently changing staff and often limited budgets. Also for these requirements, Eppendorf has the right solution.



The BioFlo® 120 Auto Culture modes allow 1-touch process control for microbial and cell culture applications and make the control station the perfect workhorse for beginners.



Model	DASbox® Mini Bioreactor System	DASGIP® Parallel Bioreactor Systems
Page	366	366
Working volume range ¹⁾	60 – 250 mL	0.2 – 3.8 L
Single-use vessels available	■	■
Glass vessels, autoclavable	■	■
Stainless-steel vessels, SIP		
Interchangeable vessels	■	■
Bacteria/yeasts/fungi	■	■
Plant cells/algae	■	■
Mammalian/animal cells	■	■
Stem cells	■	■
Insect cells	■	■
Number of parallel units	Up to 24	Up to 16
Controller ²⁾	DWC	DWC
Touchscreen controller		
BioCommand®		
DASware®	■	■
Gas mixing options	4 gas (air, N ₂ , O ₂ , CO ₂)	4 gas (air, N ₂ , O ₂ , CO ₂)
Gas flow control ³⁾	TMFC	R or TMFC
Exhaust analysis	■	■
Optical density measurement	■	■
Validation		

¹⁾ Realized using multiple vessel sizes ²⁾ Controllers: DWC = DASware® control, RPC = Reactor Process Controller, BCS = BioFlo® Control Software, PLC = Programmable Logic Controller ³⁾ Gas Flow Controllers: R = Rotameter, TMFC = Thermal Mass Flow Controller



New

Model	SciVario™ twin	BioFlo® 120	BioFlo® 320
Page	367	367	367
Working volume range	0.2 – 3.8 L	0.25 – 40 L	0.25 – 40 L
Single-use vessels available	■	■	■
Glass vessels, autoclavable	■	■	■
Stainless-steel vessels, SIP			
Interchangeable vessels	■	■	■
Bacteria/yeasts/fungi	■	■	■
Plant cells/algae	■	■	■
Mammalian/animal cells	■	■	■
Stem cells	■	■	■
Insect cells	■	■	■
Number of parallel units	2		Up to 8
Controller ²⁾	VisioNize-onboard	BCS	BCS
Touchscreen controller	■	■	■
BioCommand®			
DASware®	■	■	■
Gas mixing options	4 gas (air, N ₂ , O ₂ , CO ₂)	4 gas (air, N ₂ , O ₂ , CO ₂)	4 gas (air, N ₂ , O ₂ , CO ₂)
Gas flow control ³⁾	TMFC	R or TMFC	TMFC
Exhaust analysis	■	■	■
Optical density measurement	■	■	■
Validation			



Are you searching for more bioprocess products? Have a look at our 2020/2021 bioprocess catalog - available online!

More information at www.eppendorf.com/catalog, in the Eppendorf App, and in the eShop.



www.eppendorf.com/catalog



Model	BioFlo® 510	CelliGen® 510
Page	368	368
Working volume ranges ¹⁾	10.75 – 32 L	10.75 – 32 L
Single-use vessels available		
Glass vessels, autoclavable		
Stainless-steel vessels, SIP	■	■
Interchangeable vessels		
Bacteria/yeasts/fungi	■	■
Plant cells/algae	■	■
Mammalian/animal cells		■
Stem cells		■
Insect cells	■	■
Number of parallel units		
Controller ²⁾	RPC/PLC	RPC/PLC
Touchscreen controller	■	■
BioCommand®	■	■
DASware®		
Gas mixing options	4-gas (air, N ₂ , O ₂ , CO ₂)	4-gas (air, N ₂ , O ₂ , CO ₂)
Gas flow control ³⁾	TMFC	TMFC
Exhaust analysis	■	■
Optical density measurement		
Validation	■	■

¹⁾ Realized using multiple vessel sizes ²⁾ Controllers: DWC = DASware® control, RPC = Reactor Process Controller, BCS = BioFlo® Control Software, PLC = Programmable Logic Controller ³⁾ Gas Flow Controllers: R = Rotameter, TMFC = Thermal Mass Flow Controller

Model	BioFlo® 610	BioFlo® Pro
Page	368	369
Working volume ranges ¹⁾	13 – 100 L	45 – 1,200 L
Single-use vessels available		
Glass vessels, autoclavable		
Stainless-steel vessels, SIP	■	■
Interchangeable vessels		
Bacteria/yeasts/fungi	■	■
Plant cells/algae	■	■
Mammalian/animal cells		
Stem cells		
Insect cells	■	■
Number of parallel units		
Controller ²⁾	RPC	PLC
Touchscreen controller	■	■
BioCommand®	■	■
DASware®		
Gas mixing options	2-gas (air, O ₂)	2-gas (air, O ₂)
Gas flow control ³⁾	TMFC	TMFC
Exhaust analysis	■	■
Optical density measurement		
Validation	■	■

Parallel Bioprocessing for Unparalleled Results – Small-Scale Systems



DASbox® Mini Bioreactor System
60 – 250 mL working volume (autoclavable)
65 – 250 mL working volume (single-use)

Product features

- > 4-fold parallel system expandable to up to 24 vessels
- > Suitable for glass and/or single-use vessels, that can be used in any combination
- > Vessels can be run independently or in parallel
- > Suitable for cell culture and microbial fermentation
- > Compact mini bioreactor system: requires only 7 cm (3 inches) bench space per bioreactor
- > Optimal tool for DoE and scale down approaches
- > Agitation control supporting overhead-driven Rushton, marine-type or pitched blade impellers
- > Innovative liquid-free temperature control system needs no cooling agent supply and supports independent temperature control for each bioreactor
- > Accurate monitoring and control of pH, DO, and level
- > Variable speed pumps for accurate liquid addition and operation in batch, fed-batch, continuous, and cyclic perfusion mode
- > 4 mass flow controllers per bioreactor allow for individual mixing of air, N₂, O₂, and CO₂ to headspace and/or submerged aeration
- > Novel liquid-free Peltier exhaust condenser with easy to handle slide in – slide out activation and deactivation
- > DASware® control Software for advanced process control
- > Compatible with DASware Software Suite for interconnectivity and bioprocess information management



DASGIP® Parallel Bioreactor Systems
200 mL – 3.8 L working volume (autoclavable)
250 mL – 1.25 L working volume (single-use)

Product features

- > 4-fold parallel system expandable to up to 16 vessels
- > Suitable for glass and/or single-use vessels, that can be used in any combination
- > Vessels can be run independently or in parallel
- > DASGIP Bioblock for advanced and user-friendly temperature control or temperature control via heat blankets and cooling fingers (benchttop bioreactors)
- > Suitable for cell culture, microbial fermentation, and phototrophic cultivation
- > Modular design of control units allows for flexible system configurations that meet the demands of specific applications
- > Control of agitation, pH, level, and DO (including customizable cascade modes) in each bioreactor
- > Variable speed pumps for accurate liquid addition and operation in batch, fed-batch, continuous, and cyclic perfusion mode
- > Optical absorbance measurement for online calculation of e.g. OD₆₀₀ or cell dry weight
- > TMFC individual gas mixing of air, N₂, O₂, and CO₂
- > Online calculation of OTR, CTR, and RQ
- > DASware control Software for advanced process control
- > Compatible with DASware Software Suite for interconnectivity and bioprocess information management

Exceedingly Versatile – Bench-Scale Fermentors and Bioreactors



SciVario™ twin
200 mL – 3.8 L working volume (autoclavable)
250 mL – 3.75 L working volume (single-use)

Product features

- > Parallel operation of 2 glass and/or BioBLU single-use bioreactors, in any combination of vessel types, independently run or in parallel
- > Suitable for cell culture and microbial fermentation
- > Tempering well for advanced and user-friendly temperature control or temperature control via heat blankets and cooling fingers (benchttop bioreactors)
- > Future proven bay/drawer concept for further extension & reconfiguration
- > VisioNize-onboard: intuitive and exciting new user interface supporting efficient and intelligent process control
- > Integrated digital sensor technology (Mettler Toledo ISM® and Hamilton ARC®), supporting analog sensors for pH and DO and optical DO sensors
- > Compact design, 15-30 cm of benchspace needed per vessel
- > Variable speed pumps for accurate liquid addition and operation in batch and fed-batch mode
- > Wide range TMFC to allow for individual mixing of air, N₂, O₂, and CO₂ to headspace and/or submerged aeration
- > Compatible with DASware® control software for advanced process control

BioFlo® 120

0.4 – 10.5 L working volume (autoclavable),
0.25 – 40 L working volume (single-use)

Product features

- > Flexible software platform for universal control of both microbial and cell culture applications
- > Auto Culture modes offer process control at the touch of a button
- > Compatible with BioBLU® Single-Use Vessels for fermentation and cell culture applications
- > Precise temperature control provided through interchangeable heat-blanketed or water-jacketed vessels
- > High precision thermal mass flow controller (TMFC) for automatic gas flow control
- > Automatic gas mix for four independent sparge gas supplies
- > Available analog input/output connection for direct integration of accessories (i.e. scales, variable-speed pumps, etc.)
- > Integrated Mettler Toledo® Intelligent Sensor Management (ISM) platform
- > Compatible with DASware Software Suite or BioCommand for bioprocess information management



BioFlo® 320

0.6 – 10.5 L working volume (autoclavable),
0.25 – 40 L working volume (single-use)

Product features

- > Interchangeable autoclavable and BioBLU Single-Use Vessels
- > Integrated Mettler Toledo Intelligent Sensor Management (ISM) platform
- > Control up to eight systems from a single user interface
- > Universal control for both microbial and cell culture applications
- > Field-upgradable TMFC drawers for sparge and overlay gas
- > Enhanced software package with new cascade and time profile features
- > Built-in optical pH sensing technology for use with the BioBLU Single-Use Vessels
- > DeltaV™ compatibility available through DeltaV Discovery and DeltaV ProPlus PAS
- > Up to six integrated pumps capable of operating in variable-speed mode
- > Eight independently controlled process gas supplies
- > Validation packages available for GMP regulated processes
- > Compatible with DASware Software Suite or BioCommand for bioprocess information management



Industry Standards Meet Flexibility - Sterilizable-in-Place Fermentors and Bioreactors



BioFlo® 510 and CelliGen® 510
Bench- and pilot-scale SIP fermentor and bioreactor
10.75 - 32 L working volume

Product features

- > SIP bench and pilot scale reactors designed to meet the needs of R&D through production
- > Modular design allows for complete system flexibility
- > Add or remove components pre- or post-delivery
- > Multiple impeller and gas flow options
- > Integrated skid design with mobile table option to simplify transport
- > Features intuitive RPC control software and touchscreen interface
- > Optional Allen Bradley® PLC
- > Integrated load cell for online vessel volume monitoring
- > Fully automated SIP sequence for sterilization
- > Flush mounted vessel ports for enhanced vessel design and drainability
- > Validation packages available
- > 7 additional analog input/output connections for local integration of ancillary equipment
- > ASME-rated pressure vessel



BioFlo® 610
Pilot-scale SIP fermentor
13 - 100 L working volume

Product features

- > Pilot production system without the traditional cost or footprint
- > Modular design allows for complete system flexibility
- > Add or remove components pre- or post-delivery
- > Multiple impeller and gas flow options
- > Integrated mobile skid simplifies transport
- > Features intuitive RPC control software and touchscreen interface
- > Integrated load cell for online vessel volume monitoring
- > Fully automated SIP sequence for sterilization
- > Flush mounted vessel ports for enhanced vessel design and drainability
- > Validation packages available
- > 7 additional analog input/output connections for local integration of ancillary equipment
- > ASME-rated pressure vessel



BioFlo® Pro
Large-scale SIP fermentor
45 - 1,200 L working volume

Product features

- > Large scale industrial system supporting operation in accordance to cGMP and GAMP® guidelines
- > Modular design with over a hundred options allows for high level of customization pre and post delivery
- > Multiple impeller and gas flow options
- > NEMA-4 (IP65) rated control cabinet with industry-standard Allen Bradley® PLC
- > Open piping skid allows for easy accessibility
- > Fully automated SIP sequence for sterilization
- > Clean-in-Place (CIP) options available for vessel and piping
- > Flush mounted vessel ports for enhanced vessel design and drainability
- > Validation packages available
- > ASME-rated pressure vessel



BioBLU® Single-Use Vessels – Dependability through Proven Design

Single-use simplicity

With renowned polymer expertise, Eppendorf is proud to offer the largest portfolio of rigid walled stirred-tank single-use vessels – in small and bench scale, to be operated with parallel DASbox Mini Bioreactor System, DASGIP Parallel Bioreactor Systems or BioFlo bench-scale systems.



From 65 mL to 40 L, working volume, Eppendorf has a single-use solution to meet your needs

Product features

- > Proven performance and scalability of stirred-tank design
- > User-friendly set-up for rapid turnaround, shorter development times and lower operating costs
- > Specifically adapted designs available for microbial applications
- > Packed-bed configuration with Fibra-Cel disks is ideal for perfusion/continuous processes
- > Non-invasive or industry standard sensor technology



BioBLU c Single-Use Vessels for cell culture applications

Single-use solutions for small and bench scale cell culture applications. A full portfolio of vessels covers a working volume range of 100 mL - 40 L, offering unmatched scalability. The single-layer polymer design mitigates issues related to leachables and extractables.



BioBLU 5p Single-Use Vessel with packed bed

For the cultivation of adherent cells and for perfusion processes we offer the BioBLU 5p packed-bed vessel. It utilizes the proprietary Eppendorf packed-bed impeller design and is pre-loaded with Fibra-Cel® disks. Providing a shear-free environment, it is a premium choice in a wide variety of applications, including the production of secreted products and stem cell culture.



BioBLU f Single-Use Vessels for microbial applications

Single-use solutions for small and bench scale fermentation applications, covering a working volume range of 65 mL – 3.75 L. Fermentation processes have high mass transfer and heat removal requirements. Proven stirred-tank design, powerful overhead drives featuring Rushton-type impellers, and effective cooling make it possible for the BioBLU f vessels to achieve these demands.



BioBLU Single-Use Vessel Adaptor Kits

BioBLU vessels are designed for use with the Eppendorf DASbox and DASGIP systems, BioFlo 120, and BioFlo 320. A range of adaptor kits is offered as well, enabling your existing bioreactor system for single-use operation without the expense of replacing the whole system.

BioBLU Single-Use Vessel bundles for your BioFlo 120 or 320 provide you with highest flexibility. It is easy to switch your bioreactor system from single-use to reusable vessel usage, back and forth.

Eppendorf Bioprocess Software – Much More Than Just Bioprocess Control

Eppendorf offers BioCommand and DASware control Supervisory Control and Data Acquisition (SCADA) software packages for advanced bioprocess control. The comprehensive DASware software suite provides next-generation bioprocess management.

DASware software suite

Next-generation bioprocess management

A suite of smart and flexible software solutions to accelerate bioprocess development, with DASware control for parallel bioprocess control. The DASware licences enable interconnectivity of bioreactors with external lab-devices, comprehensive data- and information management, Design of Experiments (DoE) and remote control of bioprocesses. DASware can be used with any Eppendorf benchtop bioreactor solution.



DASware control

> Advanced process monitoring, control, and data logging - for parallel cultivation with individual control of each bioreactor



DASware connect

> Integration into process control systems and legacy corporate historians facilitating company-wide access to all relevant bioprocess data



DASware access

> Remote monitoring and control of bioprocesses via PC, Notebook and Netbook or with the DASGIP iApp via iPhone®, iPod touch® and iPad®



DASware design

> Applies the Design of Experiments (DoE) concept via a full factorial DoE builder or by importing DoE designs from third-party DoE tools

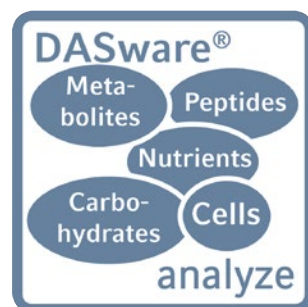

DASware analyze

> Seamless integration of external lab devices to the bioreactor allows for process automation and feedback control loops



DASware discover

> A comprehensive and user-friendly information management solution for bioprocessing

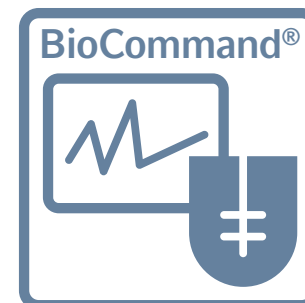

BioCommand software

The BioCommand software enhances your ability to monitor, control, and log data from your fermentation and cell culture processes through your personal computer. Three distinct packages provide the tools needed for research, optimization, and if needed, the security and audit trails to support your regulatory requirements.

- > **Track and Trend:** Provides the ability to trend and control parameter setpoints, establish alarm settings, and produce batch records; and is ideal for basic process management
- > **Batch Control:** Additional enhanced control features including a sophisticated programming module, custom synoptic display window, and equipment lock feature
- > **Batch Control Plus:** Includes three levels of security, event logs, and audit-trail capabilities to be compatible with the FDA 21 CFR Part 11

Features	Track and Trend	Batch Control	Batch Control Plus	DASware control
Batch info	■	■	■	■
User-defined event log	■	■	■	■
Summary	■	■	■	■
Loop info	■	■	■	■
Alarms	■	■	■	■
Trend graphs	■	■	■	■
Data log	■	■	■	■
Reports	■	■	■	■
Graphical programming		■	■	
Script programming		■	■	■
Synoptic display		■	■	■
Equipment lock		■	■	■
Audit trail/security			■	■
21 CFR Part 11			■	■ ¹⁾
OPC compliance	■	■	■	■
Parallel calibration				■
DASware compatibility				■

¹⁾ 21 CFR Part 11 compatibility is available for DASware control as an optional package. Please contact us for further information.



epServices
for premium performance



Application Support

You can expect the highest standards of support for your products and applications from Eppendorf.



Our teams of Application Specialists and our highly trained Product Support Staff in the international Support Centers are pleased to help you with advice and assistance for all kinds of questions about our products and their applications:

Our highly trained Scientific Support Staff is available in all time zones to assist you with any questions concerning the handling of our products for achieving reliable results.



Seminars and Training

Professional training of your staff helps you achieve reliable and reproducible results in your laboratory every day. Our courses will teach you how to perform workflows in a straightforward manner as well as how to handle and maintain your instruments.



Our aim is to develop the necessary expertise within your team and to find practical solutions to your specific questions. On our website, we offer various workshops and webinars on specific laboratory topics in the areas of manual and automated Liquid Handling, Sample Handling, Cell Handling and Bioprocessing.

For up-to-date information go to www.eppendorf.com/training



Technical Service

Eppendorf is committed to providing complete service plans for your instruments to help you maintain premium performance of our instruments in your laboratory. Our technical and certification services will give you the sense of security over your instrument uptime, and performance - guaranteed by the high quality of our original spare parts. We inspect your instrument and provide a detailed report of its present condition as well as an estimate for maintenance, certification, or repair services, if deemed necessary.

Maintenance and Certification

Be ensured that, thanks to the regular maintenance, calibration and certification (Installation and Operational Qualification - IQ/OQ) services performed by our trained service technicians, your precision instruments will continuously achieve repeatable results.



Documentation is supplied to help you prepare for your quality compliance & audits.

epServices

Eppendorf is known as a market leader in providing outstanding quality and consistently reliable instruments and consumables. Above all, we are committed to providing cost-efficient, reliable services and tools to help you maintain premium performance for maximum productivity and uptime of our instruments and reproducibility of your application results. These services are performed by our dedicated Application, Training, and Technical Service teams worldwide.

Our certification support is designed to support compliance with your laboratory guidelines.



Application Support



Seminars and Trainings



Technical Service and Support



Maintenance and Certification

www.eppendorf.com/epServices



Knowledge Base

Various Application Notes, Short Protocols, FAQs, and videos are available on our website.

SERVICE PRODUCTS

SERVICE PRODUCTS

Pipette Performance Plans



Preventive Maintenance, Calibration and Adjustment Services

Precision and accuracy of the pipettes and dispensers are important for the quality of all your work results. Regular maintenance and calibration by Eppendorf assures a consistent result quality.

We offer a range of service options:

- > We maintain every pipette's conformity to ISO 8655 or manufacturer specifications
- > Customized designed calibration services
- > From quick economical calibration to calibration in ISO 17025 accredited laboratories in our major markets

We provide high-quality pipette and dispenser calibration, certification, maintenance and repair services for all major brands of pipettes and dispensers – not just our own.

Value of service

- > Consistent, reliable liquid handling handheld instruments
- > Highest confidence in results
- > GLP supporting documentation

Spa and Wellness for your liquid-handling handheld instruments to generate reproducible results



www.eppendorf.com/pipette-video



Service Operation	BASIC	STANDARD	PREMIUM	CALIBRATION ISO 17025 ⁴⁾
Order Number for calibration for fixed-volume pipettes	0050 600 015	0050 600 017	0050 600 025	0082 000 000
Order Number for calibration for adjustable-volume pipettes and dispensers	0050 600 071	0050 600 076	0050 600 084	0082 000 001
Order Number for calibration for 8-channel pipettes	0050 600 116	0050 600 122	0050 600 092	0082 000 002
Order Number for calibration for 12-channel pipettes	0050 600 128	0050 600 130	0050 600 033	0082 000 003
Order Number for calibration for 16-channel pipettes	0082 000 104	0082 000 105	0082 000 106	0082 000 107
Order Number for calibration for 24-channel pipettes	0082 000 114	0082 000 115	0082 000 116	0082 000 117
Initial inspection to determine pipette condition			■	
Replace all defective parts ¹⁾			■	
Maintenance and Cleaning		■	■	■
Cleaning and lubrication of seals, o-rings and piston, replacement of small parts like seals and o-rings, checking seals for damage/integrity				
Calibration according to ISO 8655		■	■	■
10 measurements per test volume (min, mid, max) ²⁾				
Verification	■			
4 measurements per test volume (min, mid, max) ²⁾				
Documentation	■	■	■	■
Issue calibration report				
ISO 17025 Calibration Certificate⁴⁾				■
Comprehensive certificate including ISO 17025 accreditation mark of the laboratory				
Supporting Information	3-5	3-5	3-5	3-5
Service turnaround (from time of receipt, in business days) ³⁾				

¹⁾ Handgrip, motor and PCB are priced separately. ²⁾ 10 %, 50 % and 100 % of nominal volumes. ³⁾ Standard value, deviations possible, excl. shipping duration. ⁴⁾ Calibration in accredited laboratories

■ BASIC

Affordable verification

■ STANDARD

Maintenance and calibration according to ISO 8655

■ PREMIUM

Total care calibration services according to ISO 8655

■ CALIBRATION ISO 17025

Certificate with comprehensive data according to ISO 17025

> CUSTOMIZED

e.g. testing according to customer specifications

i For more and up-to-date information go to www.eppendorf.com/epServices.

Performance Plans are available in selected countries only and service offer may differ.

Additional services

- > Trade-in program
- > Reminder of service intervals
- > Customized maintenance contracts
- > Inspection of pipettes from all manufacturers – not just Eppendorf
- > Emergency service
- > On-site service
- > Pipette training, with emphasis on ergonomics (PhysioCare Concept®)



epMotion® 96 Performance Plans



epMotion 96 Performance Plans

The Eppendorf epMotion 96 is a semi-automated electronic pipette system for fast and precise parallel 96-channel microplate processing. The reliability of the electronic parallel pipetting system movement is the prerequisite for high precision and reproducibility of the results across the whole 96- or 384-well plate. Maintaining and verifying your system's accuracy and precision on a regular basis is thus highly recommended to make sure your system still dispenses according to the specification.

In the end you will receive assured results with your downstream applications and your valuable samples and reagents. Eppendorf offers a range of services for different user requirements including GLP supporting documentation

Value of service

- > Confirmation of performance with manufacturer specifications
- > Confidence in results
- > GLP supporting documentation

96 x confidence by verified performance!

i For more and up-to-date information go to www.eppendorf.com/epServices. Performance Plans are available in selected countries only and service offer may differ.

eppendorf

Performance tested on

Model: _____

Serial no.: _____

Serviced by: _____

Service no.: _____

Next service: _____

Date: _____

epServices
for premium performance

Service Operation	ESSENTIAL CHECK	ADVANCED MAINTENANCE	PREMIUM SERVICE	Installation Qualification (IQ)	Operational Qualification (OQ)
Order Number	0082 030 003	0082 030 004	0082 030 005	0082 030 007	0082 030 008
Checks and Maintenance					
Cleaning		■	■		
Lubrication of dispensing head		■	■		
Checking and exchanging of 96 o-rings from cones	■	■	■		
Software/firmware update if necessary		■	■		
Verification (Calibration)					
Leak Test (50 µL and 300 µL)	■	■	■	■	■
Gravimetric Test – systematic error (50 µL and 300 µL)		■	■		■
Photometric Test – random error (2 volumes)		■	■		■
Documentation					
Check list provided	■	■	■		
Dated service sticker to confirm Eppendorf service	■	■	■	■	■
Calibration Report		■	■		■
IQ Report				■	
OQ Report/Certificate					■
Supporting Information					
Discount on parts replacement, labor and travel time of repairs outside scope of preventive maintenance visit (where Eppendorf product warranty has expired)			■ ¹⁾		
Contract period	one year	one year	one year	n/a	n/a
Number of preventive services included	one	one	one	n/a	n/a

Order Number for combined Installation and Operational Qualification (IQ/OQ) services: 0082 030 009

Additionally, if you require a Customized Service we will be very pleased to discuss your requirements.

¹⁾ Please contact your local Eppendorf Service representative for details of discounts and/or any potential additional charges applying.

epMotion® Performance Plans



epMotion Performance Plans

epMotion and its dispensing tools are precision instruments. As such, they should be regularly maintained and calibrated which will help ensure continuing high accuracy, precision and reproducibility. With our Performance Plans options we help you maintain premium performance of your epMotion over an extended period of time. Our qualified service technicians will take care of your instrument. Our Certification Services include all function tests, calibration and adjustment services needed for Installation and Operational Qualification (IQ/OQ) of your instrument.

Dispensing tools calibration

Calibration of the dispensing tools are based on ISO 8655 supporting your GLP documentation.

Find more information about our training program at www.eppendorf.com/training

Value of service

- > Confidence in high-quality results and instrument reliability
- > Simple service process
- > Professional maintenance

Keep your process in motion!



Order Numbers for combined Installation and Operational Qualification (IQ/OQ) services:

- > For epMotion® 5070: 0082 030 019
- > For epMotion® 5073: 0082 030 039
- > For epMotion® 5075: 0082 030 029

Additionally, if you require a Customized Service, exchanges of spare parts, we will be very pleased to discuss your requirements.

Order Numbers for additional services:

- > 1-channel dispensing tool calibration (< epBlue™ 40.0): 5070 005 036
- > 8-channel dispensing tool calibration (< epBlue™ 40.0): 5070 005 044
- > 1-channel dispensing tool calibration (≥ epBlue™ 40.0): 0050 600 255
- > 8-channel dispensing tool calibration (≥ epBlue™ 40.0): 0050 600 259
- > Thermal module calibration: 5075 005 018
- > TMX Module calibration: 5075 005 174
- > HEPA filter exchange: 5073 920 061
- > UV lamp exchange: 5073 920 070

For more and up-to-date information go to www.eppendorf.com/epServices. Performance Plans are available in selected countries only and service offer may differ.

Service Operation	ESSENTIAL CHECK	ADVANCED MAINTENANCE	PREMIUM SERVICE	Installation Qualification (IQ)	Operational Qualification (OQ)
Order Number for epMotion® 5070	0082 030 013	0082 030 014	0082 030 015	0082 030 017	0082 030 018
Order Number for epMotion® 5073	0082 030 033	0082 030 034	0082 030 035	0082 030 037	0082 030 038
Order Number for epMotion® 5075	0082 030 023	0082 030 024	0082 030 025	0082 030 027	0082 030 028
Cleaning and Maintenance					
Cleaning of housing/accessories	■	■	■		
Checking epMotion® for external visible damages	■	■	■	■	■
Exchange of CAN bus cables/o-rings of dispensing tools		■	■		
Software update ¹⁾	■	■	■	■	■
Functional Check					
Instrument set-up, initial operation, instruction of user				■	
Tip ejector, level sensor and carrier	■	■	■		■
Barcode Reader with epBlue™ ID ¹⁾	■	■	■		
Thermal modules ¹⁾ and vacuum chamber ¹⁾	■	■	■	■	■
TMX module ¹⁾ /TMX module w. Magnetic Finger module ¹⁾	■	■	■	■	■
UV light/CleanCap (HEPA Filter) ¹⁾	■	■	■	■	■
Memory					
Evaluation of stored data		■	■		
Verification					
Calibration/adjustment of level sensor and carrier		■	■	■	■
Calibration/adjustment of vacuum chamber ¹⁾		■	■		
Verification of operating parameters acc. to specifications					■ ³⁾
Documentation					
Check list provided	■	■	■		
Dated service sticker to confirm Eppendorf service	■	■	■	■	■
IQ Report and Certificate				■	
OQ Report and Certificate					■
Supporting Information					
Discount on parts replacement, labor and travel time of repairs outside scope of preventive maintenance visit (where Eppendorf product warranty has expired)			■ ²⁾		
Contract period	one year	one year	one year	n/a	n/a
Number of preventive services included	one	one	one	n/a	n/a

¹⁾ Where feature is present. ²⁾ Please contact your local Eppendorf Service representative for details of discounts and/or any potential additional charges applying. ³⁾ The detailed certification service contents are listed in the OQ Report.

Certification Plans	BASIC
Order Number	5075 005 182
Installation and Operational Qualification (IQ/OQ): according to Eppendorf SOPs incl. one single and one 8-channel dispensing tool calibration (based on ISO 8655), complete documentation and certificates	■
epMotion®/epBlue™ User Starter Training: incl. training documents and certificates	■
epMotion® GxP Software User, Administrator Lab and Administrator IT: incl. training documents and certificates	■
Additional Services:	Order no.
epMotion® GxP Software Upgrade, Installation and User/Administrator Training, epMotion®/epBlue™ Version	5075 005 220
epMotion® GxP Software Operational Qualification (OQ), according to Eppendorf SOP's, incl. one single-channel and one 8-channel dispensing tool calibration (based on ISO 8655)	5075 005 212
epMotion® GxP Software – single channel dispensing tool calibration (based on ISO 8655)	5075 005 239
epMotion® GxP Software – 8-channel dispensing tool calibration (based on ISO 8655)	5075 005 247
epMotion® GxP Software User Training	5075 005 263

epMotion® Application Implementation

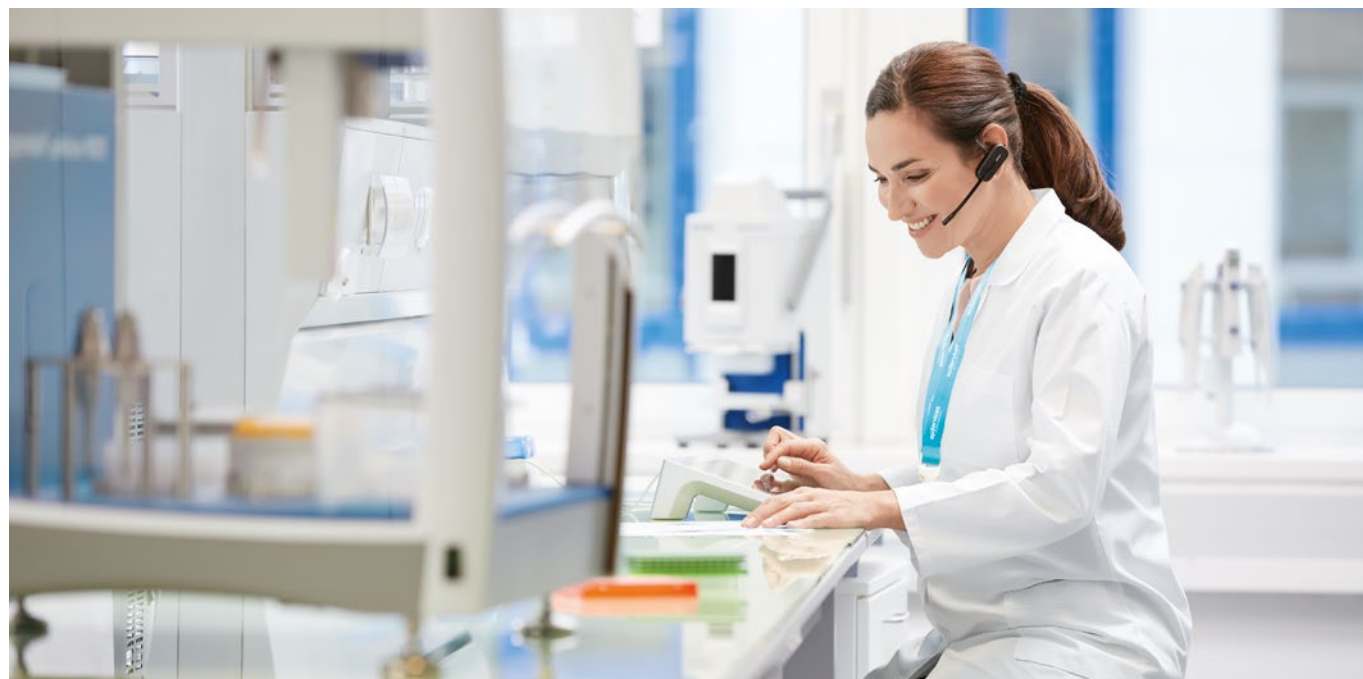

Automated Pipetting – difficult Application?

Are you having trouble with a protocol or are not sure how to optimize your automated application? We are happy to advise and assist you with your application. Eppendorf offers various application support services for epMotion users with low to high throughput experiments. Our network of highly skilled and extensively trained In-Field Automation Specialist are available for comprehensive application training and support after installation of your epMotion and during the setup of your own advanced methods.

More ready-to-go methods, labware and software updates are available for downloading from our VIP login web page.

www.eppendorf.com/automation

Application Implementation Terms

Eppendorf will provide the on-site support to program your epMotion methods for a single application as well as optimize all liquid classes needed for the application to the best of the instrument's capability. An initial in-house feasibility test is performed. Upon completion of the method on the customer's epMotion, the application will be approved by the user. Optimization to the maximum level of performance!

i For additional information, go to www.eppendorf.com/epServices.

Liquid Class Optimization and Eppendorf Training Center offers are only available in selected countries and the services offered may vary.

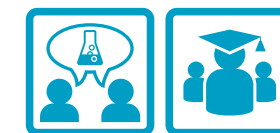

Application Implementation, Seminars and Training Options

Application Implementation¹⁾	on request
<ul style="list-style-type: none"> > The Eppendorf epMotion® Application Implementation agreement standard is intended for both new and existing instruments. Eppendorf will provide the on-site support to program the desired application methods for a single application as well as optimize all liquid classes needed. All users will receive a customized training that will include all necessary elements to properly use this workflow. In addition, a customized user guide will be prepared and given to the account during their training, which includes instructions on reagent volumes, deck setup and accessories needed. 	
Liquid Class Optimization¹⁾	0082 030 169
<ul style="list-style-type: none"> > Initial inspection of the liquid > Adjustment of liquid class parameters > Confirmation that liquid is handled to the best of the instrument's capability 	
On-site Training	
> epMotion® introductory training: epBlue™ software programming and usage, hardware functionalities, etc	on request
> epMotion® GxP software - two days training	5075 005 263

¹⁾ Our In-Field Application Specialist accomplishes the programming, optimization and/or support of an application project beyond the scope covered in the seminars and training. The application contract does not include or guarantee the generation of application relevant data. All equipment (epMotion® and tools) must be within calibration and in good working condition prior to the initiation of the Application Implementation agreement. All liquids/reagents and consumables (tips, plates, tubes etc.) needed must be provided by the user.



Temperature Control and Mixing Performance Plans



Temperature Control and Mixing Performance Plans

The right heating, cooling and mixing conditions are made very easy with our Temperature Control and Mixing instruments. We also understand that slight deviations in temperature and mixing frequency of your samples can affect their reaction conditions and may lead to non-reproducible results. To guarantee you the precise function of the instrument we offer manufacturer designed maintenance services. Our certification services support your Quality Management requirements with Installation Qualification (IQ) and Operational Qualification (OQ) in accordance with manufacturer specifications.

With our Performance Plans options we will make sure that your instruments are in good working condition by professional maintenance and certification service.

Value of service

- > Reliable system operation and results
- > GLP supporting documentation

We care for your samples – with our mix of services

For more and up-to-date information go to www.eppendorf.com/epServices. Performance Plans are available in selected countries only and service offer may differ.

eppendorf

Performance tested on

Model: _____

Serial no.: _____

Serviced by: _____

Service no.: _____

Next service: _____

Date: _____

epServices
for premium performance

Service Operation	ESSENTIAL CHECK	ADVANCED MAINTENANCE	PREMIUM SERVICE	Installation Qualification (IQ)	Operational Qualification (OQ)
Order Number	0082 100 003	0082 100 004	0082 100 005	0082 100 007	0082 100 008
External Checks and Maintenance					
Cleaning of housing		■	■		
Visual check of housing	■	■	■		
Visual check of plate holder		■	■		
Cleaning of accessories		■	■		
Visual check of accessories	■	■	■		
Internal Equipment and Fittings					
Cleaning of internal parts and assemblies		■	■		
Visual check of internal parts and assemblies		■	■		
Visual check of electrical connection		■	■		
Functional Check					
Check of delivery				■	
Instrument set-up and initial operation				■	
Instruction of user				■	
LED, display, and keyboard check		■	■		
Check of vortex sensor		■	■		
Functional check with service functions		■	■		
Check of SmartBlock or exchangeable thermoblock detection	■	■	■		■
Check of mixing, heating, cooling, and vortexing ¹⁾	■	■	■		
Check and measurement of mixing, heating, cooling, and vortexing					■
Check of overload protection		■	■		
Check of fans		■	■		
Check of ThermoTop detection		■	■		
Check of timer					■
Memory					
Evaluation of stored data		■	■		
Documentation					
Check list provided	■	■	■		
Dated service sticker to confirm Eppendorf service	■	■	■	■	■
IQ Report and Certificate				■	
OQ Report and Certificate					■
Supporting Information					
Discount on parts replacement, labor and travel time of repairs outside scope of preventive maintenance visit (where Eppendorf product warranty has expired)			■ ²⁾		
Contract period	one year	one year	one year	N/A	N/A
Number of preventive services included	one	one	one	N/A	N/A

Order Number for combined Installation and Operational Qualification (IQ/OQ) services: 0082 100 009

Additionally, if you require a Customized Service we will be very pleased to discuss your requirements.

¹⁾ Without measurement. ²⁾ Please contact your local Eppendorf Service representative for details of discounts and/or any potential additional charges applying.



Centrifuge Performance Plans



Centrifuge Performance Plans

Quality Management Systems increasingly ask for regular service of centrifuges and rotors in either an operational or a disassembled state to ensure a safe working environment. Functional inspections ensure that all technical specifications, such as temperature accuracy, rotational speed and operating time comply with the manufacturer specifications. The Centrifuge Performance Plans assist with your preparation for internal and external audits.

Value of service

- > Highest degree of security in your lab
- > GLP supporting documentation
- > Productive long life of the system

Relax while your samples are spinning safely!



Take a break and watch this video about recommended routine maintenance of your centrifuge www.eppendorf.com/centrifuge-video

For more and up-to-date information go to www.eppendorf.com/epServices. Performance Plans are available in selected countries only and service offer may differ.

eppendorf

Performance tested on

Model: _____

Serial no.: _____

Serviced by: _____

Service no.: _____

Next service: _____

Date: _____

epServices
for premium performance

Service Operation	ESSENTIAL CHECK	ADVANCED MAINTENANCE	PREMIUM SERVICE	Installation Qualification (IQ)	Operational Qualification (OQ)
Order Number for microcentrifuge w/o refrigeration	0082 020 003	0082 020 004	0082 020 005	5424 860 036	0082 020 008
Order Number for microcentrifuge with refrigeration	0082 020 013	0082 020 014	0082 020 015	5424 860 044	0082 020 018
Order Number for multipurpose w/o refrigeration	0082 020 023	0082 020 024	0082 020 025	5810 860 040	0082 020 028
Order Number for multipurpose with refrigeration	0082 020 033	0082 020 034	0082 020 035	5810 860 059	0082 020 038
Cleaning and Maintenance					
Cleaning of housing/Checking condensation water tray ¹⁾	■	■	■		
Cleaning and checking of rotor bowl and internal parts		■	■		
Checking of instrument for any damage	■	■	■		■
Checking of stability, housing, display and keypad		■	■		
Software update if required		■	■		
Checking of lid latch	■	■	■		■
Functional check					
Instrument set-up/Initial operation/Instruction of user				■	
Checking of rotor detection	■	■	■		
Checking of temperature sensors ¹⁾ and speed sensor		■	■		■
Checking of imbalance detection ¹⁾		■	■		
Performing system test run	■	■	■	■	■
Memory					
Evaluating of stored data		■	■		
Verification					
Verification of operating parameters according to specifications					■ ³⁾
Documentation					
Check list provided	■	■	■		
Dated service sticker to confirm Eppendorf service	■	■	■	■	■
IQ Report and Certificate				■	
OQ Report and Certificate					■
Supporting Information					
Discount on parts replacement, labor and travel time of repairs outside scope of preventive maintenance visit (where Eppendorf product warranty has expired)			■ ²⁾		
Contract period	one year	one year	one year	N/A	N/A
Number of preventive services included	one	one	one	N/A	N/A

Order numbers for combined Installation & Operational Qualification (IQ/OQ) services:

- > For microcentrifuge w/o refrigeration: 0082 020 009
- > For microcentrifuge with refrigeration: 0082 020 019
- > For multipurpose w/o refrigeration : 0082 020 029
- > For multipurpose with refrigeration: 0082 020 039

Additionally, if you require a Customized Service we will be very pleased to discuss your requirements.

¹⁾ Where feature is present. ²⁾ Please contact your local Eppendorf Service representative for details of discounts and/or any potential additional charges applying. ³⁾ The detailed certification service contents are listed in the OQ Report.

Inspection service for rotors	Recommended service periods	Fixed-angle rotors	Swing-bucket rotors and buckets
Visual rotor inspection ¹⁾	Annually	5424 860 109	5810 860 113

¹⁾ For all Eppendorf rotors and accessories

Order Number for obligatory check of rotor according to country-specific regulations: 5424 860 150

Attention:

All rotors must be clean and dry before inspection, or additional cleaning charges apply at prevailing rates.



Photometry Performance Plans



Photometry Performance Plans

Qualitative and reproducible results depend upon quality instrumentation and measurements. To optimize photometric and fluorometric precision, accuracy, and linearity, your instrument should be routinely checked and adjusted by a qualified Eppendorf Service Technician. Photometry Performance Plans include a choice of preventive maintenance programs which are designed to verify that your instrument meets manufacturer specifications. We also take care of the optics cleaning, instrument adjustments and provide you with full documentation and certificates.

Installation Qualification (IQ) and Operational Qualification (OQ) certification services support your Quality Management requirements, providing you with qualified assurance that your photometer is delivering the highest possible quality results.

Value of service

- > Reliable system operation over the total system lifetime
- > GLP supporting documentation

Stay tuned to the right wavelength!

For more and up-to-date information go to www.eppendorf.com/epServices. Performance Plans are available in selected countries only and service offer may differ.

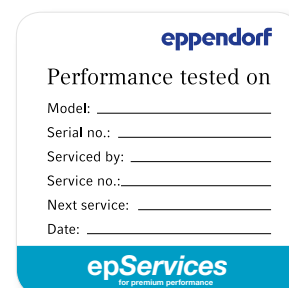

Service Operation	ESSENTIAL CHECK	ADVANCED MAINTENANCE	PREMIUM SERVICE	Installation Qualification (IQ)	Operational Qualification (OQ)
Order Number for Eppendorf BioPhotometer® D30	0082 110 003	0082 110 004	0082 110 005	0082 110 007	6132 005 018
Order Number for Eppendorf BioSpectrometer®	0082 110 013	0082 110 014	0082 110 015	0082 110 017	6135 005 019
Cleaning and Maintenance					
Cleaning of housing and cuvette shaft	■	■	■		
Cleaning and inspection of internal parts and light path		■	■		
Checking for damages	■	■	■	■	■
Inspection of housing/Testing of stability	■	■	■	■	
Software update		■	■		
Functional Check					
Instrument set-up, initial operation, instruction of user				■	
Checking of keyboard, and display	■	■	■		■
Testing of printer output and USB port (master/slave ¹⁾)	■	■	■		■
Setting number of flashes		■	■		
dsDNA test – 260 nm (Biophotometer plus)	■	■	■		
Self test (Biospectrometer/Biophotometer D30)	■	■	■	■	■
Memory					
Evaluation of stored data		■	■		■
Verification					
Photometer Test (wavelength systematic error/precision and photometric accuracy/fluorescence test ¹⁾)		■	■		■
Temperature verification/adjustment ¹⁾		■	■		■
Verification of operating parameters according to specifications					■ ²⁾
Documentation					
Check list provided	■	■	■		
Dated service sticker to confirm Eppendorf service	■	■	■	■	■
IQ Report and Certificate				■	
OQ Report and Certificate					■
Supporting Information					
Discount on parts replacement, labor and travel time of repairs outside scope of preventive maintenance visit (where Eppendorf product warranty has expired)			■ ²⁾		
Contract period	one year	one year	one year	n/a	n/a
Number of preventive services included	one	one	one	n/a	n/a

Order Numbers for combined Installation and Operational Qualification (IQ/OQ) services:

- > For Eppendorf BioPhotometer®: 0082 110 009
- > For Eppendorf BioSpectrometer®: 0082 110 019
- > Order Numbers for additional services:
- > Photometer Test for Eppendorf BioPhotometer®: 6132 005 026
- > Photometer Test for Eppendorf BioSpectrometer®: 6135 005 027
- > Photometer Test for Eppendorf BioSpectrometer® fluorescence: 6137 005 008
- > Temperature verification for Eppendorf BioSpectrometer® kinetic: 6136 005 004

¹⁾ Where feature is present. ²⁾ Please contact your local Eppendorf Service representative for details of discounts and/or any potential additional charges applying. ³⁾ The detailed certification service contents are listed in the OQ Report.



Mastercycler® Performance Plans



Mastercycler Performance Plans

To ensure your instrument is operating consistently at peak performance and to guarantee reproducible results over an extended period of time, we offer service programs to meet your needs. Our maintenance service is a prerequisite for temperature verification of the cycler. The exact adherence to defined temperatures is crucial for reproducible results.

Our certification services can support your Quality Management requirements by Installation Qualification (IQ) and Operational Qualification (OQ) in accordance with manufacturer specifications to guarantee you the precise function of the instrument. With our Performance Plans options we will make sure that your instruments are in good working condition by professional maintenance and certification service from the manufacturer.

Additional stand-alone temperature verification and certification services:

Temperature verification of selected well positions and adjustment of the cycler block temperature if necessary is highly recommended to ensure instrument consistency and accuracy.

Sequential temperature verification – measuring one temperature at the time

Order Number:

- > For Mastercycler® X50, pro, nexus: 6321 897 000
- > Temperature verification system (calibrated in an ISO 17025 accredited laboratory): 0082 040 027

Parallel temperature verification - measuring various wells at the same time and of ramping speeds between 40 – 90 °C.

Order Number:

- > For Mastercycler® X50, pro, nexus, in selected countries: 6321 897 507

Please inquire locally for ordering information on Certification of Temperature Verification systems (Single-well and multi-well).

Value of service

- > High confidence in results
- > Permanently reliable and reproducible results
- > GLP supporting documentation

Keep operating – with absolute confidence

Service Operation	ESSENTIAL CHECK	ADVANCED MAINTENANCE	PREMIUM SERVICE	Installation Qualification (IQ)	Operational Qualification (OQ)
Order Number for Mastercycler® X50, pro, nexus	0082 040 043	0082 040 044	0082 040 045	0082 040 047	0082 040 048
External Checks and Maintenance					
Cleaning of MC module		■	■		
Visual check of housing	■	■	■		
Cleaning of heated lid		■	■		
Visual check of accessories		■	■		
Internal Equipment and Fittings					
Cleaning of internal parts and assemblies		■	■		
Visual check of internal parts and assemblies		■	■		
Visual check of electrical connection (incl. mains power)		■	■		
Software update		■	■		
Functional Check					
Check of delivery				■	
Instrument set-up and initial operation				■	
Instruction of the user				■	
LED, display and keyboard check	■	■	■	■	■
Check USB-interface		■	■	■	■
Check touchscreen		■	■	■	■
Check of thermoblock	■	■	■	■	■
Check of heated lid	■	■	■	■	■
Check of fan(s)	■	■	■	■	■
Temperature verification – with single-channel system		■	■	■	■
Temperature verification – with multi-channel system (if available ¹⁾)		■	■	■	■
Memory					
Evaluation of stored data		■	■		
Documentation					
Check list provided	■	■	■		
Dated service sticker to confirm Eppendorf service	■	■	■	■	■
IQ Report and Certificate				■	
OQ Report and Certificate					■
Supporting Information					
Discount on parts replacement, labor and travel time of repairs outside scope of preventive maintenance visit (where Eppendorf product warranty has expired)			■ ¹⁾		
Contract period	one year	one year	one year	n/a	n/a
Number of preventive services included	one	one	one	n/a	n/a

Order Numbers for combined Installation and Operational Qualification (IQ/OQ) services:

- > For Mastercycler® X50, pro, nexus: 0082 040 049

Additionally, if you require a Customized Service we will be very pleased to discuss your requirements.

¹⁾ Please contact your local Eppendorf Service representative for details of discounts and/or any potential additional charges applying.

eppendorf

Performance tested on

Model: _____

Serial no.: _____

Serviced by: _____

Service no.: _____

Next service: _____

Date: _____

epServices
for premium performance

For more and up-to-date information go to www.eppendorf.com/epServices. Performance Plans are available in selected countries only and service offer may differ.

ULT Freezer Performance Plans



ULT Freezer Performance Plans

Eppendorf Ultra-Low Temperature (ULT) Freezers offer you the advanced design and intuitive features you like on the outside plus the security and performance you need for your most precious samples on the inside. Reliable and efficient performance can be expected for years of smooth operation from any of our ULT Freezers, which vary in configuration and capacity. In addition to our extensive standard warranty, Eppendorf offers ULT Freezer Performance Plans to suit your lab's needs while enhancing your peace of mind.

You can choose between essential function checks, preventive maintenance plans, or Installation and Operational (IQ/OQ) certification services. These protocols are designed to check, validate, and promote reliable freezer performance that coincide with our manufacturer specifications.

Value of service

- > Increased uptime and reduced risk of system failure
- > Long lifetime of instruments
- > Confirmation of performance within manufacturer specification

Protect your priceless samples!

For more and up-to-date information go to www.eppendorf.com/epServices. Performance Plans are available in selected countries only and service offer may differ.

eppendorf

Performance tested on

Model: _____

Serial no.: _____

Serviced by: _____

Service no.: _____

Next service: _____

Date: _____

epServices
for premium performance



Service Operation	ESSENTIAL CHECK	ADVANCED MAINTENANCE	PREMIUM SERVICE	Installation Qualification (IQ)	Operational Qualification (OQ)
Order Number	0082 070 003	0082 070 004	0082 070 005	0082 070 007	0082 070 008
External Checks and Maintenance					
Check installation environment	■	■	■	■	■
Check electrical supply and fittings	■	■	■	■	■
Check CO ₂ /LN ₂ backup system installation ¹⁾	■	■	■	■	■
Check independent temperature monitoring system ¹⁾	■	■	■	■	■
Operation of freezer lid gas strut (chest freezer only)	■	■	■	■	■
Alignment of door handle	■	■	■	■	■
Alignment and sealing of outer door (upright freezer only)	■	■	■	■	■
Air filter inspection and cleaning	■	■	■	■	■
Internal Equipment and Fittings					
Inspection and cleaning of heated vent/condensor	■	■	■	■	■
Condition and function of inner doors/lids	■	■	■	■	■
Compressors: operating temperature check	■	■	■	■	■
Cooling fan: condition of fan motor, bearings, fan blades	■	■	■	■	■
Condition of insulation – accessible cooling circuit pipes	■	■	■	■	■
Condition of accessible electrical wiring	■	■	■	■	■
Display and function keys operation	■	■	■	■	■
Chamber temperature sensor function, alarms function	■	■	■	■	■
RS-232 communications port functionality check	■	■	■	■	■
Validation and Metrology					
Validation and adjustment of operating parameters to within Eppendorf specifications	■	■	■	■	■ ²⁾
Documentation					
Check list provided	■	■	■	■	■
Dated service sticker to confirm Eppendorf service	■	■	■	■	■
IQ Report and Certificate	■	■	■	■	■
OQ Report and Certificate	■	■	■	■	■
Supporting Information					
Discount on parts replacement, labor and travel time of repairs outside scope of preventive maintenance visit (where Eppendorf product warranty has expired)	■	■	■ ²⁾	■	■
Contract period	one year	one year	one year	n/a	n/a
Number of preventive services	one	one	one	n/a	n/a

Order Number for combined Installation and Operational Qualification (IQ/OQ) services: 0082 070 009

Additionally, if you require a Customized Service we will be very pleased to discuss your requirements.

¹⁾ Where this optional feature is present. ²⁾ Please contact your local Eppendorf Service representative for details of discounts and/or any potential additional charges applying. ³⁾ The detailed certification service contents are listed in the OQ Report: e.g. test of battery, alarm, vacuum effectiveness, and final test run.



Cell Manipulation Performance Plans



Cell Manipulation Performance Plans

From our knowledgeable Sales and Field Application Specialists to our trained Customer Service and Technical Service Group, our entire team demonstrates a passion for helping you achieve success with your cell manipulation work. Our combination of excellent products and service will prepare you for optimal performance.

With our Performance Plans options we will ensure that your instruments are in good working condition by professional inspection and maintenance service including the exchange of parts due to wear and tear.

Installation Qualification and Operational Qualification (IQ/OQ) services assure that your Eppendorf cell manipulation instruments are delivered, installed, and consistently operating at peak performance to manufacturer specifications. IQ/OQ certification can support documentation for your Quality Management System.

Value of service

- > Reliable system operation at peak performance over the total lifetime of the system
- > GLP supporting documentation

Precise and accurate instruments will further improve your Cell Manipulation success!

For more and up-to-date information go to www.eppendorf.com/epServices. Performance Plans are available in selected countries only and service offer may differ.

eppendorf

Performance tested on

Model: _____

Serial no.: _____

Serviced by: _____

Service no.: _____

Next service: _____

Date: _____

epServices
for premium performance

Service Operation	ESSENTIAL CHECK	ADVANCED MAINTENANCE	PREMIUM SERVICE	Installation Qualification (IQ)	Operational Qualification (OQ)
Order Number for Electroporators	0082 010 003	0082 010 004	0082 010 005	0082 010 007	0082 010 008
Order Number for Microinjectors/Micromanipulators	0082 010 013	0082 010 014	0082 010 015	0082 010 017	0082 010 018
External Checks and Maintenance					
Cleaning of housing	■	■	■		
Checking of keyboard		■	■		■
Visual inspection of display		■	■		■
Stability test	■	■	■		
Internal Equipment and Fittings					
Cleaning of internal assemblies		■	■		
Leak-tightness test (CellTram®/FemtoJet®)	■	■	■		■
Oil exchange (CellTram® Oil/vario)	■	■	■		
Inspection of contacts (Electroporator)		■	■		■
Software upgrade		■	■		
Functional check					
Check of delivery				■	
Instrument set-up and initial operation				■	
Instruction of user				■	
Motor module test (Micromanipulator)	■	■	■		■
System test	■	■	■		■
Memory					
Analysis of error statistics	■	■	■		■
Documentation					
Check list provided	■	■	■		
Dated service sticker to confirm Eppendorf service	■	■	■	■	■
IQ Report and Certificate				■	
OQ Report and Certificate					■
Supporting Information					
Discount on parts replacement, labor and travel time of repairs outside scope of preventive maintenance visit (where Eppendorf product warranty has expired)			■ ¹⁾		
Contract period	one year	one year	one year	N/A	N/A
Number of preventive services included	one	one	one	N/A	N/A

Order Numbers for combined Installation and Operational Qualification (IQ/OQ) services:

- > For Electroporators: **0082 010 009**
- > For Microinjectors/Micromanipulators: **0082 010 019**
- > Eppendorf PiezoXpert® Actuator Verification: **5194 075 016**

Additionally, if you require a Customized Service we will be very pleased to discuss your requirements.

¹⁾ Please contact your local Eppendorf Service representative for details of discounts and/or any potential additional charges applying.

CO₂ Incubator Performance Plans



CO₂ Incubator Performance Plans

CO₂ incubators are the pivotal instruments in cell culture labs. They feature complex, dynamic control systems to maintain user-defined culturing parameters. Accurate measurement and control feedback of multiple environmental variables is necessary in order to optimize cell growth and proliferation, at the same time minimizing intercellular variation in physiology, metabolic function and expression. CO₂ Incubator Performance Plan components include a choice of preventive maintenance protocols designed to check, validate and to promote continuous and stable incubator performance, optimizing instrument conformity with programmed culturing parameters. Installation Qualification (IQ) and Operational Qualification (OQ) certification services support your Quality Management requirements by providing you with qualified assurance that your CO₂ incubator is functioning correctly, in accordance with manufacturer specifications.

Value of service

- > Reliable results over an extended period of time
- > Improves consistency and productivity of culturing

Our service culture for peace of mind!

For more and up-to-date information go to www.eppendorf.com/epServices. Performance Plans are available in selected countries only and service offer may differ.

eppendorf

Performance tested on

Model: _____

Serial no.: _____

Serviced by: _____

Service no.: _____

Next service: _____

Date: _____

epServices
for premium performance



Service Operation	ESSENTIAL CHECK	ADVANCED MAINTENANCE	PREMIUM SERVICE	Installation Qualification (IQ)	Operational Qualification (OQ)
Order Number	0082 060 003	0082 060 004	0082 060 005	0082 060 007	0082 060 008
External Checks and Maintenance					
Check installation environment	■	■	■	■	■
Check electrical/gas supply and fittings		■	■	■	■
Replace in-line gas filter(s) and auto-zero filter		■	■		■
Check door seals and door hinges		■	■	■	■
Internal Equipment and Fittings					
Check condition of all chamber gas, temperature, humidity sensors		■	■	■	■
Check security of incubator shelf/shelves and racking system		■	■	■	■
Check sensor covers are present and undamaged		■	■		■
Check condition of humidity trays		■	■		■
Check condition of wiring system, PCB's, display and controller		■	■		■
Check alarms functionality		■	■		■
Validation and Metrology					
Validation and adjustment of operating parameters within Eppendorf specifications	■	■	■		■ ²⁾
Documentation					
Check list provided	■	■	■		■
Dated service sticker to confirm Eppendorf service	■	■	■	■	■
IQ Report and Certificate				■	
OQ Report and Certificate					■
Supporting Information					
Discount on parts replacement, labor and travel time of repairs outside scope of preventive maintenance visit (where Eppendorf product warranty has expired)			■ ¹⁾		
Contract period	one year	one year	one year	n/a	n/a
Number of preventive services included	one	one	one	n/a	n/a

Order Number for combined Installation and Operational Qualification (IQ/OQ) services: 0082 060 009

Additionally, if you require a Customized Service we will be very pleased to discuss your requirements.

¹⁾ Please contact your local Eppendorf Service representative for details of discounts and/or any potential additional charges applying. ²⁾ The detailed certification service contents are listed in the OQ Report: e.g. verification of temperature, CO₂, speed, alarm, and final test run.

SERVICE PRODUCTS

SERVICE PRODUCTS



Biological Shaker Performance Plans



Biological Shaker Performance Plans

Biological shakers are essential to cell culture applications and are required to be in continuous use for years. Relatively small, short-term variations in shaker operation can significantly influence culturing outcomes, with negative effects on yields and/or cell expression. Eppendorf's Biological Shaker Performance Plans ensure consistent, reliable shaker performance meeting manufacturer specifications. Biological Shaker Performance Plans include a choice of preventive maintenance protocols which are designed to check and validate stable shaker performance.

Installation Qualification (IQ) and Operational Qualification (OQ) certification services support your Quality Management requirements by providing you with qualified assurance that your biological shaker is functioning correctly, in accordance with manufacturer specifications.

Value of service

- > Improves reliability and consistency
- > Highest uptime and long lifetime of instruments

Care for your shaker – optimize your cultures!

For more and up-to-date information go to www.eppendorf.com/epServices. Performance Plans are available in selected countries only and service offer may differ.

eppendorf

Performance tested on

Model: _____

Serial no.: _____

Serviced by: _____

Service no.: _____

Next service: _____

Date: _____

epServices
for premium performance

Service Operation	ESSENTIAL CHECK	ADVANCED MAINTENANCE	PREMIUM SERVICE	Installation Qualification (IQ)	Operational Qualification (OQ)
Order Number for shakers with heating/cooling	0082 080 003	0082 080 004	0082 080 005	0082 080 007	0082 080 008
Order Number for open air shakers	0082 080 013	0082 080 014	0082 080 015	0082 080 017	0082 080 018
Order Number for shakers with heating	0082 080 023	0082 080 024	0082 080 025	0082 080 027	0082 080 028
Order Number for shaker Innova® S44i	0082 080 213	0082 080 214	0082 080 215	0082 080 217	0082 080 218
Order Number for industrial shakers	0082 080 033	0082 080 034	0082 080 035	0082 080 037	0082 080 038
External Checks and Maintenance					
Check installation environment	■	■	■	■	■
Check electrical/gas ¹⁾ supply and fittings		■	■	■	■
Check condition/operation of any door/lid open sensors		■	■	■	■
Check security of doors/lids, handles, door struts ¹⁾ and hinges		■	■	■	■
Internal Equipment and Fittings					
Check security of shaker mechanism; lubricate non-sealed bearings, as appropriate ¹⁾		■	■		
Check shaker drive motor, and circulation fan ¹⁾		■	■		■
Check condition of shaker drive belt; adjust belt tension as necessary		■	■		
Clean and check condenser ¹⁾		■	■		
Validation and Metrology					
Validation and adjustment of operating parameters to within Eppendorf specifications	■	■	■		■ ³⁾
Documentation					
Check list provided	■	■	■		
Dated service sticker to confirm Eppendorf service	■	■	■	■	■
IQ Report and Certificate				■	
OQ Report and Certificate					■
Supporting Information					
Discount on parts replacement, labor and travel time of repairs outside scope of preventive maintenance visit (where Eppendorf product warranty has expired)			■ ²⁾		
Contract period	one year	one year	one year	n/a	n/a
Number of preventive services included	one	one	one	n/a	n/a

Order Numbers for combined Installation and Operational Qualification (IQ/OQ) services:

- > For open shaker: 0082 080 019
- > For shaker with heating: 0082 080 029
- > For shaker with heating/cooling: 0082 080 009
- > For shaker Innova® S44i: 0082 080 219
- > For industrial shaker: 0082 080 039

Additionally, if you require a Customized Service we will be very pleased to discuss your requirements.

¹⁾ Where feature is present. ²⁾ Please contact your local Eppendorf Service representative for details of discounts and/or any potential additional charges applying. ³⁾ The detailed certification service contents are listed in the OQ Report: e.g. verification of rpm, temperature, alarms, and final test run.



S41i Incubator Shaker Performance Plans



S41i Incubator Shaker Performance Plans

The versatility of the New Brunswick™ S41i Incubator Shaker supports simultaneous culture of adherent and suspension cultures. The smallest deviations in the culturing environment can result in undesirable outcomes. To ensure reproducible results and to protect your precious cultures from undesirable variables, we offer a range of maintenance services.

For your Quality Management requirements we also offer certification services that include Installation Qualification (IQ) and Operational Qualification (OQ) certification to provide optimal instrument performance, stability and accuracy of culturing parameters, in accordance with manufacturer specifications.

Value of service

- > Reliable system performance and culturing results over the entire system lifetime
- > GLP supporting documentation

Optimized system - reliable results!

For more and up-to-date information go to www.eppendorf.com/epServices. Performance Plans are available in selected countries only and service offer may differ.

eppendorf

Performance tested on

Model: _____

Serial no.: _____

Serviced by: _____

Service no.: _____

Next service: _____

Date: _____

epServices
for premium performance

Service Operation	ESSENTIAL CHECK	ADVANCED MAINTENANCE	PREMIUM SERVICE	Installation Qualification (IQ)	Operational Qualification (OQ)
Order Number	0082 050 003	0082 050 004	0082 050 005	0082 050 007	0082 050 008
External Checks and Maintenance					
Check installation environment	■	■	■	■	■
Check electrical/gas supply and fittings		■	■	■	■
Replace in-line CO ₂ filter and auto-zero filter		■	■		
Internal Equipment and Fittings					
Check security of shaker platform(s) and flask holders		■	■	■	■
Check security of incubator shelf/shelves and racking system		■	■	■	■
Replace platform support post boot seals		■	■		
Check condition of humidity trays		■	■		
Check condition of shaker drive belt		■	■		
Check condition of chamber CO ₂ and temperature sensors	■	■	■		■
Validation and Metrology					
Validation and adjustment of operating parameters to within Eppendorf specifications	■	■	■		■ ²⁾
Documentation					
Check list provided	■	■	■		
Dated service sticker to confirm Eppendorf service	■	■	■	■	■
IQ Report and Certificate				■	
OQ Report and Certificate					■
Supporting Information					
Discount on parts replacement, labor and travel time of repairs outside scope of preventive maintenance visit (where Eppendorf product warranty has expired)			■ ¹⁾		
Contract period	one year	one year	one year	n/a	n/a
Number of preventive services included	one	one	one	n/a	n/a

Order number for combined Installation & Operational Qualification (IQ/OQ) services: 0082 050 009

Additionally, if you require a Customized Service we will be very pleased to discuss your requirements.

¹⁾ Please contact your local Eppendorf Service representative for details of discounts and/or any potential additional charges applying. ²⁾ The detailed certification service contents are listed in the OQ Report: e.g. verification of temperature, CO₂, speed, alarm and final test run.

Bioprocess Performance Plans



Bioprocess Performance Plans

Bioprocess systems include several sophisticated technologies. Peak performance requires smooth interplay of the subsystems and fully functioning consumable parts. Regular maintenance by qualified engineers helps to ensure reliable operation, while deferring it can cause unreliable results, expensive repairs, and prolonged downtime. Eppendorf Bioprocess Performance Plans help you to maintain the optimal performance of your equipment over years of frequent use.



You will find details and ordering information for all Bioprocess Performance Plans in the Bioprocess Catalog 2020/2021!



www.eppendorf.com/catalog

EU-IVD Products

If your lab work is predominantly a clinical or diagnostic application EU-IVD compliant products can add peace of mind to support your documentation and accreditation requirements. Eppendorf has taken all the measurements needed to make sure the EU-IVD compliant documentation is fulfilled and furthermore CE certificates are provided.

To support regulatory compliance, Eppendorf offers manual air cushion pipettes, pipette tips, tubes and centrifuges as EU-IVD compliant, CE marked version for diagnostic applications (according to Directive 98/79/EC). EU-IVD compliant products give peace of mind by supporting your documentation and

accreditation requirements where needed. We spare you the effort of validating a “research product” for clinical purposes. EU-IVD compliant products follow the extremely high quality standards at Eppendorf. We are not making any compromises if it comes to precision, accuracy, robustness, safety and ergonomics.

We want you to concentrate on your work, for the better of mankind, and take care of necessary EU-IVD compliant documentation.

EU-IVD compliant pipettes – see page 403



EU-IVD compliant pipette tips – see page 412



EU-IVD compliant tubes – see page 418



EU-IVD compliant centrifuges – see page 419



Find out more at
www.eppendorf.com/easy-choice



EU-Medical Devices

If you are working in a lab for human in-vitro fertilization (IVF), Eppendorf micromanipulation and microinjection products compliant to the Medical Device Directive 93/42/EEC of the European Union support you with documentation and accreditation requirements.

Eppendorf has taken all the measurements needed to make sure the EU medical device compliant documentation is fulfilled and furthermore CE certificates are provided.

In-vitro fertilization (IVF) equipment – see page 431



Liquid Handling

Eppendorf Reference® 2

Description

The name "Reference" stands for extraordinary precision and accuracy, a long service life, and an ergonomic design. The Reference 2 boasts these proven premium characteristics and this operating philosophy with its innovative state-of-the-art technology.

The Reference 2 is the premium pipette of Eppendorf. Our best material and the latest technologies are implemented in this pipette, making it a reliable partner for you and your demanding work.



* The Eppendorf Reference® 2 pipette is designed and constructed for low-contamination transfer of liquids, in particular for samples from the human body and for reagents within the scope of an in-vitro diagnostic application in order to allow the in-vitro diagnostic medical device to be used as intended. This pipette is an in-vitro diagnostic device according to Directive 98/79/EC of the European Parliament and the Council dated October 27, 1998.

Single-channel pipettes, fixed volume

Ordering information

Volume range	Color code	Rel. systematic error ¹⁾	Abs. systematic error ¹⁾	Rel. random error ¹⁾	Abs. random error ¹⁾	Order no.
Eppendorf Reference® 2 (EU-IVD), single-channel, fixed						
1 µL	■ dark gray	±2.5 %	±0.025 µL	±1.8 %	±0.018 µL	4921 000 010
2 µL	■ dark gray	±2.0 %	±0.04 µL	±1.2 %	±0.024 µL	4921 000 028
5 µL	■ medium gray	±1.2 %	±0.06 µL	±0.6 %	±0.03 µL	4921 000 036
10 µL	■ medium gray	±1.0 %	±0.1 µL	±0.5 %	±0.05 µL	4921 000 044
10 µL	■ yellow	±1.2 %	±0.12 µL	±0.5 %	±0.05 µL	4921 000 052
20 µL	■ light gray	±0.8 %	±0.16 µL	±0.3 %	±0.06 µL	4921 000 060
20 µL	■ yellow	±1.0 %	±0.2 µL	±0.3 %	±0.06 µL	4921 000 079
25 µL	■ yellow	±1.0 %	±0.25 µL	±0.3 %	±0.075 µL	4921 000 087
50 µL	■ yellow	±0.7 %	±0.35 µL	±0.3 %	±0.15 µL	4921 000 095
100 µL	■ yellow	±0.6 %	±0.6 µL	±0.2 %	±0.2 µL	4921 000 109
200 µL	■ yellow	±0.6 %	±1.2 µL	±0.2 %	±0.4 µL	4921 000 117
200 µL	■ blue	±0.6 %	±1.2 µL	±0.2 %	±0.4 µL	4921 000 125
250 µL	■ blue	±0.6 %	±1.5 µL	±0.2 %	±0.5 µL	4921 000 133
500 µL	■ blue	±0.6 %	±3.0 µL	±0.2 %	±1.0 µL	4921 000 141
1,000 µL	■ blue	±0.6 %	±6.0 µL	±0.2 %	±2.0 µL	4921 000 150
2 mL	■ red	±0.6 %	±0.012 mL	±0.2 %	±0.004 mL	4921 000 168
2.5 mL	■ red	±0.6 %	±0.015 mL	±0.2 %	±0.005 mL	4921 000 176

¹⁾ The error data, according to EN ISO 8655, only apply if original Eppendorf tips are used. Technical specifications are subject to change. Errors and omissions excepted.

► Pipette service and maintenance contracts can be found on page 376-377.

Eppendorf Reference® 2

Single-channel pipettes, variable volume

Ordering information							
Volume range	Color code	Volume	Rel. systematic error ¹⁾	Abs. systematic error ¹⁾	Rel. random error ¹⁾	Abs. random error ¹⁾	Order no.
Eppendorf Reference® 2 (EU-IVD) , single-channel, variable, incl. epT.I.P.S.® Box							
0.1 – 2.5 µL	■ dark gray	0.1 µL	±48.0 %	±0.048 µL	±12.0 %	±0.012 µL	4920 000 016
		0.25 µL	±12.0 %	±0.03 µL	±6.0 %	±0.015 µL	
		1.25 µL	±2.5 %	±0.031 µL	±1.5 %	±0.019 µL	
		2.5 µL	±1.4 %	±0.035 µL	±0.7 %	±0.018 µL	
0.5 – 10 µL	■ medium gray	05 µL	±8.0 %	±0.04 µL	±5.0 %	±0.025 µL	4920 000 024
		1.0 µL	±2.5 %	±0.025 µL	±1.8 %	±0.018 µL	
		5.0 µL	±1.5 %	±0.075 µL	±0.8 %	±0.04 µL	
		10 µL	±1.0 %	±0.10 µL	±0.4 %	±0.04 µL	
2 – 20 µL	■ light gray	2.0 µL	±3.0 %	±0.06 µL	±1.5 %	±0.03 µL	4920 000 032
		10 µL	±1.0 %	±0.10 µL	±0.6 %	±0.06 µL	
		20 µL	±0.8 %	±0.16 µL	±0.3 %	±0.06 µL	
2 – 20 µL	■ yellow	2.0 µL	±5.0 %	±0.10 µL	±1.5 %	±0.03 µL	4920 000 040
		10 µL	±1.2 %	±0.12 µL	±0.6 %	±0.06 µL	
		20 µL	±1.0 %	±0.2 µL	±0.3 %	±0.06 µL	
10 – 100 µL	■ yellow	10 µL	±3.0 %	±0.3 µL	±0.7 %	±0.07 µL	4920 000 059
		50 µL	±1.0 %	±0.5 µL	±0.3 %	±0.15 µL	
		100 µL	±0.8 %	±0.8 µL	±0.2 %	±0.2 µL	
20 – 200 µL	■ yellow	20 µL	±2.5 %	±0.5 µL	±0.7 %	±0.14 µL	4920 000 067
		100 µL	±1.0 %	±1.0 µL	±0.3 %	±0.3 µL	
		200 µL	±0.6 %	±1.2 µL	±0.2 %	±0.4 µL	
30 – 300 µL	■ orange	30 µL	±2.5 %	±0.75 µL	±0.7 %	±0.21 µL	4920 000 075
		150 µL	±1.0 %	±1.5 µL	±0.3 %	±0.45 µL	
		300 µL	±0.6 %	±1.8 µL	±0.2 %	±0.6 µL	
100 – 1,000 µL	■ blue	100 µL	±3.0 %	±3.0 µL	±0.6 %	±0.6 µL	4920 000 083
		500 µL	±1.0 %	±5.0 µL	±0.2 %	±1.0 µL	
		1,000 µL	±0.6 %	±6.0 µL	±0.2 %	±2.0 µL	
Eppendorf Reference® 2 (EU-IVD) , single-channel, variable, incl. epT.I.P.S.® sample bag							
0.25 – 2.5 mL	■ red	0.25 mL	±4.8 %	±0.012 mL	±1.2 %	±0.003 mL	4920 000 091
		1.25 mL	±0.8 %	±0.010 mL	±0.2 %	±0.0025 mL	
		2.5 mL	±0.6 %	±0.015 mL	±0.2 %	±0.005 mL	
0.5 – 5 mL	■ violet	0.5 mL	±2.4 %	±0.012 mL	±0.6 %	±0.003 mL	4920 000 105
		2.5 mL	±1.2 %	±0.030 mL	±0.25 %	±0.006 mL	
		5.0 mL	±0.6 %	±0.030 mL	±0.15 %	±0.0075 mL	
1 – 10 mL	■ turquoise	1.0 mL	±3.0 %	±0.030 mL	±0.6 %	±0.006 mL	4920 000 113
		5.0 mL	±0.8 %	±0.040 mL	±0.2 %	±0.010 mL	
		10.0 mL	±0.6 %	±0.060 mL	±0.15 %	±0.015 mL	

¹⁾ The error data, according to EN ISO 8655, only apply if original Eppendorf tips are used. Technical specifications are subject to change. Errors and omissions excepted.

3-pack single-channel pipettes, variable volume

Ordering information		Order no.
Eppendorf Reference® 2		
Eppendorf Reference® 2, 3-pack (EU-IVD) , single-channel, variable, incl. epT.I.P.S.® Box or sample bag and ballpoint pen		
Option 1: 0.5 – 10 µL, 10 – 100 µL, 100 – 1,000 µL		4920 000 903
Option 2: 2 – 20 µL yellow, 20 – 200 µL, 100 – 1,000 µL		4920 000 911
Option 3: 100 – 1,000 µL, 0.5 – 5 mL, 1 – 10 mL		4920 000 920

Technical specifications subject to change.



8-channel pipettes, variable volumes

Ordering information							
Volume range	Color code	Volume	Rel. systematic error ¹⁾	Abs. systematic error ¹⁾	Rel. random error ¹⁾	Abs. random error ¹⁾	Order no.
Eppendorf Reference® 2 (EU-IVD) , 8-channel, variable, incl. epT.I.P.S.® Box							
0.5 – 10 µL	■ medium gray	0.5 µL	±12.0 %	±0.06 µL	±8.0 %	±0.04 µL	4922 000 013
		1.0 µL	±8.0 %	±0.08 µL	±5.0 %	±0.05 µL	
		5.0 µL	±4.0 %	±0.2 µL	±2.0 %	±0.1 µL	
		10 µL	±2.0 %	±0.2 µL	±1.0 %	±0.1 µL	
10 – 100 µL	■ yellow	10 µL	±3.0 %	±0.3 µL	±2.0 %	±0.2 µL	4922 000 030
		50 µL	±1.0 %	±0.5 µL	±0.8 %	±0.4 µL	
		100 µL	±0.8 %	±0.8 µL	±0.3 %	±0.3 µL	
30 – 300 µL	■ orange	30 µL	±3.0 %	±0.9 µL	±1.0 %	±0.3 µL	4922 000 056
		150 µL	±1.0 %	±1.5 µL	±0.5 %	±0.75 µL	
		300 µL	±0.6 %	±1.8 µL	±0.3 %	±0.9 µL	

¹⁾ The error data, according to EN ISO 8655, only apply if original Eppendorf tips are used. Technical specifications are subject to change. Errors and omissions excepted.

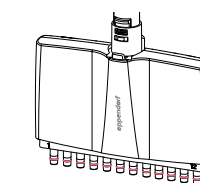

12-channel pipettes, variable volumes

Ordering information							
Volume range	Color code	Volume	Rel. systematic error ¹⁾	Abs. systematic error ¹⁾	Rel. random error ¹⁾	Abs. random error ¹⁾	Order no.
Eppendorf Reference® 2 (EU-IVD) , 12-channel, variable, incl. epT.I.P.S.® Box							
0.5 – 10 µL	■ medium gray	0.5 µL	±12.0 %	±0.06 µL	±8.0 %	±0.04 µL	4922 000 021
		1.0 µL	±8.0 %	±0.08 µL	±5.0 %	±0.05 µL	
		5.0 µL	±4.0 %	±0.2 µL	±2.0 %	±0.1 µL	
		10 µL	±2.0 %	±0.2 µL	±1.0 %	±0.1 µL	
10 – 100 µL	■ yellow	10 µL	±3.0 %	±0.3 µL	±2.0 %	±0.2 µL	4922 000 048
		50 µL	±1.0 %	±0.5 µL	±0.8 %	±0.4 µL	
		100 µL	±0.8 %	±0.8 µL	±0.3 %	±0.3 µL	
30 – 300 µL	■ orange	30 µL	±3.0 %	±0.9 µL	±1.0 %	±0.3 µL	4922 000 064
		150 µL	±1.0 %	±1.5 µL	±0.5 %	±0.75 µL	
		300 µL	±0.6 %	±1.8 µL	±0.3 %	±0.9 µL	

¹⁾ The error data, according to EN ISO 8655, only apply if original Eppendorf tips are used. Technical specifications are subject to change. Errors and omissions excepted.

Eppendorf Research® plus

The ultra light pipette that delights your hand

The Eppendorf Research plus mechanical pipette combines over 50 years of innovation in liquid handling and is one of the most commonly used pipettes in the world. It provides you with one of the safest and most ergonomic pipettes available today. The Research plus microliter pipette protects the health of our customers during their daily work in the laboratory. It has pioneered the renowned PhysioCare Concept® and thus reduced the strain on hand and arm during pipetting essentially. The Research plus is the pipette family with the lowest weight and lowest operation forces in the Eppendorf product families. Lower operation forces can only be reached with our Eppendorf electronic pipettes. Enjoy excellent flexibility and choose among single-channel pipettes in fixed or variable volume as well as multi-channel pipette options with 8, 12, 16 and 24 channels.



* The Eppendorf Research® plus pipette is designed and constructed for low-contamination transfer of liquids, in particular for samples from the human body and for reagents within the scope of an in-vitro diagnostic application in order to allow the in-vitro diagnostic medical device to be used as intended. This pipette is an in-vitro diagnostic device according to Directive 98/79/EC of the European Parliament and the Council dated October 27, 1998.

Single-channel pipettes, fixed volume

Ordering information						
Volume range	Color code	Rel. systematic error ¹⁾	Abs. systematic error ¹⁾	Rel. random error ¹⁾	Abs. random error ¹⁾	Order no.
Eppendorf Research® plus (EU-IVD), single-channel, fixed						
10 µL	medium gray	±1.2 %	±0.12 µL	±0.6 %	±0.06 µL	3121 000 015
10 µL	yellow	±1.2 %	±0.12 µL	±0.6 %	±0.06 µL	3121 000 023
20 µL	light gray	±0.8 %	±0.16 µL	±0.3 %	±0.06 µL	3121 000 031
20 µL	yellow	±1.0 %	±0.2 µL	±0.3 %	±0.06 µL	3121 000 040
25 µL	yellow	±1.0 %	±0.25 µL	±0.3 %	±0.08 µL	3121 000 058
50 µL	yellow	±0.7 %	±0.35 µL	±0.3 %	±0.15 µL	3121 000 066
100 µL	yellow	±0.6 %	±0.6 µL	±0.2 %	±0.2 µL	3121 000 074
200 µL	yellow	±0.6 %	±1.2 µL	±0.2 %	±0.4 µL	3121 000 082
200 µL	blue	±0.6 %	±1.2 µL	±0.2 %	±0.4 µL	3121 000 090
250 µL	blue	±0.6 %	±1.5 µL	±0.2 %	±0.5 µL	3121 000 104
500 µL	blue	±0.6 %	±3.0 µL	±0.2 %	±1.0 µL	3121 000 112
1,000 µL	blue	±0.6 %	±6.0 µL	±0.2 %	±2.0 µL	3121 000 120

¹⁾ The error data, according to EN ISO 8655, only apply if original Eppendorf tips are used. Technical specifications are subject to change. Errors and omissions excepted.

► Pipette service and maintenance contracts can be found on page 376-377. Pipette tips can be found on page 412 onward.

Single-channel pipettes, variable volume

Ordering information							
Volume range	Color code	Volume	Rel. systematic error ¹⁾	Abs. systematic error ¹⁾	Rel. random error ¹⁾	Abs. random error ¹⁾	Order no.
Eppendorf Research® plus (EU-IVD), single-channel, variable, incl. epT.I.P.S.® Box							
0.1 – 2.5 µL	dark gray	0.1 µL	±48.0 %	±0.048 µL	±12.0 %	±0.012 µL	3120 000 011
		0.25 µL	±12.0 %	±0.03 µL	±6.0 %	±0.015 µL	
		1.25 µL	±2.5 %	±0.031 µL	±1.5 %	±0.019 µL	
		2.5 µL	±1.4 %	±0.035 µL	±0.7 %	±0.018 µL	
0.5 – 10 µL	medium gray	0.5 µL	±8.0 %	±0.04 µL	±5.0 %	±0.025 µL	3120 000 020
		1 µL	±2.5 %	±0.025 µL	±1.8 %	±0.018 µL	
		5 µL	±1.5 %	±0.075 µL	±0.8 %	±0.04 µL	
		10 µL	±1.0 %	±0.1 µL	±0.4 %	±0.04 µL	
2 – 20 µL	light gray	2 µL	±5.0 %	±0.1 µL	±1.5 %	±0.03 µL	3120 000 097
		10 µL	±1.2 %	±0.12 µL	±0.6 %	±0.06 µL	
		20 µL	±1.0 %	±0.2 µL	±0.3 %	±0.06 µL	
2 – 20 µL	yellow	2 µL	±5.0 %	±0.1 µL	±1.5 %	±0.03 µL	3120 000 038
		10 µL	±1.2 %	±0.12 µL	±0.6 %	±0.06 µL	
		20 µL	±1.0 %	±0.2 µL	±0.3 %	±0.06 µL	
10 – 100 µL	yellow	10 µL	±3.0 %	±0.3 µL	±1.0 %	±0.1 µL	3120 000 046
		50 µL	±1.0 %	±0.5 µL	±0.3 %	±0.15 µL	
		100 µL	±0.8 %	±0.8 µL	±0.2 %	±0.2 µL	
20 – 200 µL	yellow	20 µL	±2.5 %	±0.5 µL	±0.7 %	±0.14 µL	3120 000 054
		100 µL	±1.0 %	±1.0 µL	±0.3 %	±0.3 µL	
		200 µL	±0.6 %	±1.2 µL	±0.2 %	±0.4 µL	
30 – 300 µL	orange	30 µL	±2.5 %	±0.75 µL	±0.7 %	±0.21 µL	3120 000 100
		150 µL	±1.0 %	±1.5 µL	±0.3 %	±0.45 µL	
		300 µL	±0.6 %	±1.8 µL	±0.2 %	±0.6 µL	
100 – 1,000 µL	blue	100 µL	±3.0 %	±3.0 µL	±0.6 %	±0.6 µL	3120 000 062
		500 µL	±1.0 %	±5.0 µL	±0.2 %	±1.0 µL	
		1,000 µL	±0.6 %	±6.0 µL	±0.2 %	±2.0 µL	
Eppendorf Research® plus (EU-IVD), single-channel, variable, incl. epT.I.P.S.® sample bag							
0.25 – 2.5 mL	red	0.25 mL	±4.8 %	±0.012 mL	±1.2 %	±0.003 mL	3120 000 143
		1.25 mL	±0.8 %	±0.01 mL	±0.2 %	±0.0025 mL	
		2.5 mL	±0.6 %	±0.015 mL	±0.2 %	±0.005 mL	
0.5 – 5 mL	violet	0.5 mL	±2.4 %	±0.012 mL	±0.6 %	±0.003 mL	3120 000 070
		2.5 mL	±1.2 %	±0.03 mL	±0.25 %	±0.006 mL	
		5 mL	±0.6 %	±0.03 mL	±0.15 %	±0.008 mL	
1 – 10 mL	turquoise	1 mL	±3.0 %	±0.03 mL	±0.6 %	±0.006 mL	3120 000 089
		5 mL	±0.8 %	±0.04 mL	±0.2 %	±0.01 mL	
		10 mL	±0.6 %	±0.06 mL	±0.15 %	±0.015 mL	

¹⁾ The error data, according to EN ISO 8655, only apply if original Eppendorf tips are used. Technical specifications are subject to change. Errors and omissions excepted.

3-pack single-channel pipettes, variable volume

Ordering information		Order no.
Eppendorf Research® plus		
Eppendorf Research® plus 3-pack (EU-IVD), single-channel, variable, incl. epT.I.P.S.® Box or sample bag and ballpoint pen		
Option 1: 0.5 – 10 µL, 10 – 100 µL, 100 – 1,000 µL		3120 000 909
Option 2: 2 – 20 µL yellow, 20 – 200 µL, 100 – 1,000 µL		3120 000 917
Option 3: 100 – 1,000 µL, 0.5 – 5 mL, 1 – 10 mL		3120 000 925

Eppendorf Research® plus

8-channel pipettes, variable volumes



Ordering information

Volume range	Color code	Volume	Rel. systematic error ¹⁾	Abs. systematic error ¹⁾	Rel. random error ¹⁾	Abs. random error ¹⁾	Order no.
Eppendorf Research® plus (EU-IVD) , 8-channel, variable, incl. epT.I.P.S.® Box							
0.5 – 10 µL	medium gray	0.5 µL	±12.0 %	±0.06 µL	±8.0 %	±0.04 µL	3122 000 019
		1 µL	±8.0 %	±0.08 µL	±5.0 %	±0.05 µL	
		5 µL	±4.0 %	±0.2 µL	±2.0 %	±0.1 µL	
		10 µL	±2.0 %	±0.2 µL	±1.0 %	±0.1 µL	
10 – 100 µL	yellow	10 µL	±3.0 %	±0.3 µL	±2.0 %	±0.2 µL	3122 000 035
		50 µL	±1.0 %	±0.5 µL	±0.8 %	±0.4 µL	
		100 µL	±0.8 %	±0.8 µL	±0.3 %	±0.3 µL	
30 – 300 µL	orange	30 µL	±3.0 %	±0.9 µL	±1.0 %	±0.3 µL	3122 000 051
		150 µL	±1.0 %	±1.5 µL	±0.5 %	±0.75 µL	
		300 µL	±0.6 %	±1.8 µL	±0.3 %	±0.9 µL	
120 – 1,200 µL	green	120 µL	±6.0 %	±7.2 µL	±0.9 %	±1.08 µL	3122 000 213
		600 µL	±2.7 %	±16.2 µL	±0.4 %	±2.4 µL	
		1,200 µL	±1.2 %	±14.4 µL	±0.3 %	±3.6 µL	

¹⁾ The error data, according to EN ISO 8655, only apply if original Eppendorf tips are used. Technical specifications are subject to change. Errors and omissions excepted.

Please note: 8-channel pipettes build a system only with epT.I.P.S. and ep Dualfilter T.I.P.S. SealMax, see pages 412-416

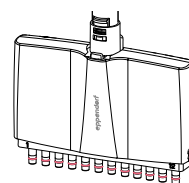

12-channel pipettes, variable volumes

Ordering information

Volume range	Color code	Volume	Rel. systematic error ¹⁾	Abs. systematic error ¹⁾	Rel. random error ¹⁾	Abs. random error ¹⁾	Order no.
Eppendorf Research® plus (EU-IVD) , 12-channel, variable, incl. epT.I.P.S.® Box							
0.5 – 10 µL	medium gray	0.5 µL	±12.0 %	±0.06 µL	±8.0 %	±0.04 µL	3122 000 027
		1 µL	±8.0 %	±0.08 µL	±5.0 %	±0.05 µL	
		5 µL	±4.0 %	±0.2 µL	±2.0 %	±0.1 µL	
		10 µL	±2.0 %	±0.2 µL	±1.0 %	±0.1 µL	
10 – 100 µL	yellow	10 µL	±3.0 %	±0.3 µL	±2.0 %	±0.2 µL	3122 000 043
		50 µL	±1.0 %	±0.5 µL	±0.8 %	±0.4 µL	
		100 µL	±0.8 %	±0.8 µL	±0.3 %	±0.3 µL	
30 – 300 µL	orange	30 µL	±3.0 %	±0.9 µL	±1.0 %	±0.3 µL	3122 000 060
		150 µL	±1.0 %	±1.5 µL	±0.5 %	±0.75 µL	
		300 µL	±0.6 %	±1.8 µL	±0.3 %	±0.9 µL	
120 – 1,200 µL	green	120 µL	±6.0 %	±7.2 µL	±0.9 %	±1.08 µL	3122 000 221
		600 µL	±2.7 %	±16.2 µL	±0.4 %	±2.4 µL	
		1,200 µL	±1.2 %	±14.4 µL	±0.3 %	±3.6 µL	

¹⁾ The error data, according to EN ISO 8655, only apply if original Eppendorf tips are used. Technical specifications are subject to change. Errors and omissions excepted.

Please note: 12-channel pipettes build a system only with epT.I.P.S. and ep Dualfilter T.I.P.S. SealMax, see pages 412-416

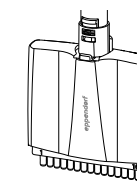

16-channel pipettes, variable volume, for 384-well plates

Ordering information

Volume range	Color code	Volume	Rel. systematic error ¹⁾	Abs. systematic error ¹⁾	Rel. random error ¹⁾	Abs. random error ¹⁾	Order no.
Eppendorf Research® plus (EU-IVD) , 16-channel, variable, incl. epT.I.P.S.® Box							
1 – 20 µL	light pink	1 µL	±12 %	±0.12 µL	±8 %	±0.08 µL	3122 000 078
		2 µL	±8 %	±0.16 µL	±5 %	±0.1 µL	
		10 µL	±4 %	±0.4 µL	±2 %	±0.2 µL	
		20 µL	±2 %	±0.4 µL	±1 %	±0.2 µL	
5 – 100 µL	light yellow	5 µL	±6 %	±0.3 µL	±4 %	±0.2 µL	3122 000 094
		10 µL	±3 %	±0.3 µL	±2 %	±0.2 µL	
		50 µL	±1.2 %	±0.6 µL	±0.8 %	±0.4 µL	
		100 µL	±1 %	±1 µL	±0.6 %	±0.6 µL	

¹⁾ The error data, according to EN ISO 8655, only apply if original Eppendorf tips are used. Technical specifications are subject to change. Errors and omissions excepted.

Please note: 16-channel pipettes build a system only with epT.I.P.S. 384, see page 417

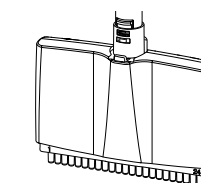

24-channel pipettes, variable volume, for 384-well plates

Ordering information

Volume range	Color code	Volume	Rel. systematic error ¹⁾	Abs. systematic error ¹⁾	Rel. random error ¹⁾	Abs. random error ¹⁾	Order no.
Eppendorf Research® plus (EU-IVD) , 24-channel, variable, incl. epT.I.P.S.® Box							
1 – 20 µL	light pink	1 µL	±12 %	±0.12 µL	±8 %	±0.08 µL	3122 000 086
		2 µL	±8 %	±0.16 µL	±5 %	±0.1 µL	
		10 µL	±4 %	±0.4 µL	±2 %	±0.2 µL	
		20 µL	±2 %	±0.4 µL	±1 %	±0.2 µL	
5 – 100 µL	light yellow	5 µL	±6 %	±0.3 µL	±4 %	±0.2 µL	3122 000 108
		10 µL	±3 %	±0.3 µL	±2 %	±0.2 µL	
		50 µL	±1.2 %	±0.6 µL	±0.8 %	±0.4 µL	
		100 µL	±1 %	±1 µL	±0.6 %	±0.6 µL	

¹⁾ The error data, according to EN ISO 8655, only apply if original Eppendorf tips are used. Technical specifications are subject to change. Errors and omissions excepted.

Please note: 24-channel pipettes build a system only with epT.I.P.S. 384, see page 417

epT.I.P.S.[®]

* The pipette tips of the epT.I.P.S.[®] product group with the respective product numbers are designed and constructed for low-contamination transfer of liquids, in particular for samples from the human body and for reagents within the scope of an in-vitro diagnostic application in order to allow the in-vitro diagnostic medical device to be used as intended. The above mentioned epT.I.P.S.[®] are in-vitro diagnostic devices according to Directive 98/79/EC of the European Parliament and the Council dated October 27, 1998.

Description

For epT.I.P.S. – the original Eppendorf “Totally Integrated Pipetting System” – the tips are optimally coordinated to Eppendorf pipettes and, of course, meet EN ISO 8655 requirements. This has resulted in minimal attachment and ejection forces with the highest level of tightness. Optimal wetting properties, high transparency and special, certified purity grades are the visible expression of our product and production philosophy.

Applications

- > Pipetting liquids
- > Dispensing liquids
- > Mixing liquids
- > Filling plates and reaction vessels

Product features

- > The ergonomically optimized cone geometry provides the optimal pipette fit on the Eppendorf pipette
- > Fine graduations make visual checks of the pipetting volume even easier
- > Long, narrow tips reach the base of narrow and high vessels without touching the top of the vessel edge
- > Fine retracted or extended tips simplify work with small volumes
- > Available in purity grades of: Eppendorf Quality, PCR clean, sterile, Biopur[®]
- > Color-coded trays make volume identification and allocation of Eppendorf pipettes easier than ever

For more information go to www.eppendorf.com/epTips

Overview about Packaging Units

**Box/Set**

- > Contamination-free transfer of trays to stable working box
- > System optimized for use with multi-channel pipettes
- > Color-coded trays for simple identification of tips and pipette
- > Tips can be attached to pipette from refill trays
- > Boxes and trays are autoclavable
- > Packaging units Box and Set available

**epT.I.P.S.[®] Racks**

- > Biopur pipette tips offer the highest biological purity grade
- > Certified PCR clean, sterile, pyrogen-, ATP- and DNA-free
- > ep Dualfilter T.I.P.S. SealMax pre-sterilized packed in disposable Racks
- > Each production lot inspected by an independent laboratory
- > Lot-specific certificates available at www.eppendorf.com/certificates
- > Sterility packaging is compliant to standards DIN EN ISO 11607 and DIN EN 868-2-10

**epT.I.P.S.[®] Singles**

- > Biopur pipette tip, individually wrapped
- > Certified PCR clean, sterile, pyrogen-, ATP- and DNA-free
- > For use in medical, pharmaceutical and food industry, molecular biology and cell technology
- > Batch number and expiration date on each blister package
- > Each production lot inspected by an independent laboratory
- > Lot-specific certificates available at www.eppendorf.com/certificates







**epT.I.P.S.[®] Reloads**

- > Reduced waste as compared with disposable racks
- > The refill trays can be autoclaved up to 121 °C, in packaging and without foil, for subsequent use
- > The refill system, depending on tips size, is packaged as either dual-sided or in stack form
- > Available in purity grades of Eppendorf Quality and PCR clean
- > Color-coded trays for simple volume and pipette identification



epT.I.P.S.®

Volume range/epT.I.P.S.®
(all tips shown are actual size)

	Reloads	Reloads
dark gray 0.1 – 10 µL, 34 mm  CE*	960 tips (10 trays × 96 tips) 0030 073 363	960 tips (10 trays × 96 tips) 0030 073 746
medium gray 0.1 – 20 µL, 40 mm  CE*	960 tips (10 trays × 96 tips) 0030 073 380	960 tips (10 trays × 96 tips) 0030 073 762
light gray 0.5 – 20 µL, 46 mm  CE*	960 tips (10 trays × 96 tips) 0030 073 401	960 tips (10 trays × 96 tips) 0030 073 789
yellow 2 – 200 µL, 53 mm  CE*	960 tips (10 trays × 96 tips) 0030 073 428	960 tips (10 trays × 96 tips) 0030 073 800
orange 20 – 300 µL, 55 mm  CE*	960 tips (10 trays × 96 tips) 0030 073 444	960 tips (10 trays × 96 tips) 0030 073 827
blue 50 – 1,000 µL, 71 mm  CE*	960 tips (10 trays × 96 tips) 0030 073 460	960 tips (10 trays × 96 tips) 0030 073 843
green 50 – 1,250 µL, 76 mm  CE*	960 tips (10 trays × 96 tips) 0030 073 487	960 tips (10 trays × 96 tips) 0030 073 860

¹⁾ This article is available from May 2020.

* The pipette tips of the epT.I.P.S.® product group with the respective product numbers are designed and constructed for low-contamination transfer of liquids, in particular for samples from the human body and for reagents within the scope of an in-vitro diagnostic application in order to allow the in-vitro diagnostic medical device to be used as intended. The above mentioned epT.I.P.S.® are in-vitro diagnostic devices according to Directive 98/79/EC of the European Parliament and the Council dated October 27, 1998.



Box	Set	Singles	Racks
1 reusable box × 96 tips 0030 073 002 New 0030 076 397 ¹⁾	480 tips (5 trays × 96 tips), 1 reusable box 0030 073 207 New 0030 076 494 ¹⁾		
1 reusable box × 96 tips 0030 073 029 New 0030 076 400 ¹⁾	480 tips (5 trays × 96 tips), 1 reusable box 0030 073 223 New 0030 076 508 ¹⁾	100 tips, individually packed 0030 010 019	480 tips (5 racks × 96 tips) 0030 075 323
1 reusable box × 96 tips 0030 073 045 New 0030 076 419 ¹⁾	480 tips (5 trays × 96 tips), 1 reusable box 0030 073 240 New 0030 076 516 ¹⁾		
1 reusable box × 96 tips 0030 073 061 New 0030 076 427 ¹⁾	480 tips (5 trays × 96 tips), 1 reusable box 0030 073 266 New 0030 076 524 ¹⁾	100 tips, individually packed 0030 010 035	480 tips (5 racks × 96 tips) 0030 075 331
1 reusable box × 96 tips 0030 073 088 New 0030 076 435 ¹⁾	480 tips (5 trays × 96 tips), 1 reusable box 0030 073 282 New 0030 076 532 ¹⁾		480 tips (5 racks × 96 tips) 0030 075 340
1 reusable box × 96 tips 0030 073 100 New 0030 076 443 ¹⁾	480 tips (5 trays × 96 tips), 1 reusable box 0030 073 304 New 0030 076 540 ¹⁾	100 tips, individually packed 0030 010 051	480 tips (5 racks × 96 tips) 0030 075 358
1 reusable box × 96 tips 0030 073 126 New 0030 076 451 ¹⁾	480 tips (5 trays × 96 tips), 1 reusable box 0030 073 320 New 0030 076 559 ¹⁾		480 tips (5 racks × 96 tips) 0030 075 366



epT.I.P.S.®

Volume range/epT.I.P.S.®

(all tips shown are actual size)

■ dark green

50 – 1,250 µL L, 103 mm



CE*

Reloads

960 tips (10 trays × 96 tips)

0030 073 606

Reloads

960 tips (10 trays × 96 tips)

0030 073 614



■ red

0.25 – 2.5 mL, 115 mm



CE*

480 tips (10 trays × 48 tips)

0030 073 509

480 tips (10 trays × 48 tips)

0030 073 886

■ violet

0.1 – 5 mL, 120 mm



CE*

■ violet

0.2 – 5 mL L, 175 mm



CE*

■ turquoise

0.5 – 10 mL, 165 mm



CE*

¹⁾ This article is available from May 2020.

* The pipette tips of the epT.I.P.S.® product group with the respective product numbers are designed and constructed for low-contamination transfer of liquids, in particular for samples from the human body and for reagents within the scope of an in-vitro diagnostic application in order to allow the in-vitro diagnostic medical device to be used as intended. The above mentioned epT.I.P.S.® are in-vitro diagnostic devices according to Directive 98/79/EC of the European Parliament and the Council dated October 27, 1998.



Box

1 reusable box × 96 tips

0030 073 622

New 0030 076 460¹⁾

Set

240 tips (5 trays × 48 tips), 1 reusable box

0030 073 347

New 0030 076 567¹⁾

Racks

480 tips (5 racks × 96 tips)

0030 075 374

1 reusable box × 48 tips

0030 073 142

New 0030 076 478¹⁾

240 tips (5 racks × 48 tips)

0030 075 382

1 reusable box × 24 tips

0030 073 169

New 0030 076 486¹⁾

120 tips (5 racks × 24 tips)

0030 075 390

120 tips (5 racks × 24 tips)

0030 075 404

120 tips (5 racks × 24 tips)

0030 075 412

ep Dualfilter T.I.P.S.[®] SealMaxVolume range/ ep Dualfilter T.I.P.S.[®] SealMax

light gray

0.1 – 10 µL S, 34 mm



dark gray

0.5 – 20 µL L, 46 mm



yellow

2 – 100 µL, 53 mm



yellow

2 – 200 µL, 55 mm



orange

20 – 300 µL, 55 mm



blue

50 – 1,000 µL, 76 mm



Racks

960 tips (10 racks × 96 tips)

0030 078 756

960 tips (10 racks × 96 tips)

0030 078 764

960 tips (10 racks × 96 tips)

0030 078 772

960 tips (10 racks × 96 tips)

0030 078 780

960 tips (10 racks × 96 tips)

0030 078 799

960 tips (10 racks × 96 tips)

0030 078 802

* The pipette tips of the ep Dualfilter T.I.P.S.[®] SealMax product group with the respective product numbers are designed and constructed for low-contamination transfer of liquids, in particular for samples from the human body and for reagents within the scope of an in-vitro diagnostic application in order to allow the in-vitro diagnostic medical device to be used as intended. The above mentioned ep Dualfilter T.I.P.S.[®] SealMax are in-vitro diagnostic devices according to Directive 98/79/EC of the European Parliament and the Council dated October 27, 1998.

epT.I.P.S.[®] 384

epT.I.P.S. 384 with SOFTattach technology for 16 and 24-channel pipettes

For the first time, micropipette tips have elastic forming grooves. They allow the tips to stretch as much as necessary to enable a perfect seal while operating forces are reduced to a minimum. Your benefits of using this perfectly coordinated system of pipette and tip are outstanding and reliable tip fit and tightness combined with reduced tip attachment and ejection forces. It couldn't be easier to perfectly hit all 384 wells as the new micropipette tips have an extremely fine tip shape, and an extraordinary coaxiality which enables a perfect tip alignment.



Product features

- > Designed for a cone distance of 4.5 mm
- > epT.I.P.S. 384 pipette tips build a system together with the Research plus and Xplorer plus 16 and 24-channel pipettes for utmost safety and reliability
- > Innovative SOFTattach technology allows for reliable tip fit and tightness
- > Fill a whole 384-well plate without loosening pipette tips
- > Perfect tip alignment by extraordinary coaxiality for safe plate maneuvering and liquid transfer
- > The tip shape of the epT.I.P.S. 384 is adjusted to perfectly fit the wells of 384-well plates
- > Tip attachment forces reduced by 40 % per cone compared to 8 and 12-channel pipettes
- > Tip ejection forces reduced by SOFTattach for ergonomic working conditions
- > Available as reload, and set
- > Available in purity grades: Eppendorf Quality and PCR clean

Applications

- > In vitro diagnostics
- > Immunoassays
- > Blood analysis
- > Allergy diagnostics
- > Detection of infectious diseases
- > Biochemical assays such as pyruvate - lactate reaction
- > CE-IVD kits, such as *real-time* PCR kits

Volume range/epT.I.P.S.[®] 384
(all tips shown are actual size)

light pink

0.1 – 20 µL, 42 mm



light yellow

0.5 – 100 µL, 53 mm



Reloads

3,840 tips (10 trays × 384 tips)

0030 076 060

3,840 tips (10 trays × 384 tips)

0030 076 079

Set

1,920 tips (5 trays × 384 tips),
1 reusable box

0030 076 087

New 0030 076 370¹⁾1,920 tips (5 trays × 384 tips),
1 reusable box

0030 076 095

New 0030 076 389¹⁾¹⁾This article is available from May 2020.

* The pipette tips of the epT.I.P.S. 384 product group with the respective product numbers are designed and constructed for low-contamination transfer of liquids, in particular for samples from the human body and for reagents within the scope of an in-vitro diagnostic application in order to allow the in-vitro diagnostic medical device to be used as intended. The above mentioned epT.I.P.S. 384 are in-vitro diagnostic devices according to Directive 98/79/EC of the European Parliament and the Council dated October 27, 1998.

Sample Handling

Eppendorf Tubes® 5.0 mL

New



Product features

- > Low risk of contamination with easy sample access
- > Storage space for samples and liquid solutions in volumes up to 5 mL is significantly reduced
- > No leaching - made of high-quality, virgin polypropylene, highly transparent, free of plasticizers, biocides and mold release agents
- > Ensured tightness over a broad temperature range
- > Centrifugation stability up to 25,000 × g

CE*

Eppendorf Safe-Lock Tubes

New



Product features

- > Hinged Eppendorf Safe-Lock lid prevents unintentional lid opening during incubation and storage
- > Polypropylene provides high resistance to chemicals, mechanical stress and temperature extremes
- > Manufactured without the use of slip agents, plasticizers, and biocides – substances that have been shown to leach from plastic consumables into the sample and negatively affect bio-assay results
- > g-Safe®: Depending on Safe-Lock Tube variant (see manual) exceptional centrifugation stability up to 30.000 × g prevents sample loss due to tube breakage and provides extra safety when working with hazardous samples
- > Precise lid sealing for minimal evaporation rates during long-term storage
- > Large frosted lid and surface on the side for easy labeling
- > Ensured functionality from -86 °C to 100 °C
- > Autoclavable when open (121 °C, 20 min)

CE*

Ordering information

Description	Order no.
Eppendorf Tubes® 5.0 mL (EU-IVD)	
Eppendorf Quality™, colorless, 200 tubes (2 bags × 100 tubes)	0030 119 517
Eppendorf Safe-Lock Tubes (EU-IVD)	
0.5 mL, Eppendorf Quality™, colorless, 500 tubes	0030 121 503
1.5 mL, Eppendorf Quality™, colorless, 1,000 tubes	0030 121 872
2.0 mL, Eppendorf Quality™, colorless, 1,000 tubes	0030 121 880

* The Eppendorf Tubes® are designed and constructed for the primary containment and preservation of specimens derived from the human body, with the exception of blood. Those Eppendorf Tubes are in vitro diagnostic devices according to Directive 98/79/EC of the European Parliament and the Council dated October 27, 1998.

Sample Handling

MiniSpin®/MiniSpin® plus



CE*

* The MiniSpin®/MiniSpin® plus is designed for separating liquid substance mixtures with different densities, in particular, for processing and analyzing samples from the human body in in-vitro diagnostic applications to ensure that the in-vitro diagnostic device can be used according to its intended purpose. This centrifuge including components is an in-vitro diagnostic device according to Directive 98/79/EC of the European Parliament and the Council dated October 27, 1998.

Ordering information

Description	Order no.
Centrifuge MiniSpin® (EU-IVD) , non-refrigerated, with Rotor F-45-12-11, 230 V/50 – 60 Hz	5452 000 018
Centrifuge MiniSpin® plus (EU-IVD) , non-refrigerated, with Rotor F-45-12-11, 230 V/50 – 60 Hz	5453 000 011
Rotor F-45-12-11	5452 720 008
Rotor F-55-16-5 PCR	5452 727 007
Adapter , for 1 tube 0.5 mL or microtainer, max. Ø 8 mm, for all 1.5/2.0 mL rotors, set of 6 pcs.	5425 716 001
Adapter , for 1 PCR tube 0.2 mL, max. Ø 6 mm, for all 1.5/2.0 mL rotors, set of 6 pcs.	5425 715 005
Adapter , for 1 tube 0.4 mL, max. Ø 6 mm, for all 1.5/2.0 mL rotors, set of 6 pcs.	5425 717 008

✂ Ordering information for other voltage options begins on page 450

Centrifuge 5418 R



CE*

* The Centrifuge 5418 R is designed for separating liquid substance mixtures with different densities, in particular, for processing and analyzing samples from the human body in in-vitro diagnostic applications to ensure that the in-vitro diagnostic device can be used according to its intended purpose. This centrifuge including components is an in-vitro diagnostic device according to Directive 98/79/EC of the European Parliament and the Council dated October 27, 1998.

Ordering information

Description	Order no.
Centrifuge 5418 R (EU-IVD) , refrigerated, with Rotor FA-45-18-11 and rotor lid, 230 V/50 – 60 Hz	5401 000 013
Adapter , for 1 tube 0.5 mL or microtainer, max. Ø 8 mm, for all 1.5/2.0 mL rotors, set of 6 pcs.	5425 716 001
Adapter , for 1 PCR tube 0.2 mL, max. Ø 6 mm, for all 1.5/2.0 mL rotors, set of 6 pcs.	5425 715 005
Adapter , for 1 tube 0.4 mL, max. Ø 6 mm, for all 1.5/2.0 mL rotors, set of 6 pcs.	5425 717 008

✎ Ordering information for other voltage options begins on page 450

i For more information go to www.eppendorf.com/centrifugation

Centrifuge 5420



CE*

* The Centrifuge 5420 is designed for separating liquid substance mixtures with different densities, in particular, for processing and analyzing samples from the human body in in-vitro diagnostic applications to ensure that the in-vitro diagnostic device can be used according to its intended purpose. This centrifuge including components is an in-vitro diagnostic device according to Directive 98/79/EC of the European Parliament and the Council dated October 27, 1998.

Ordering information

Description	Order no.
Centrifuge 5420 (EU-IVD) , non-refrigerated, without rotor, keypad, 230 V/50/60 Hz	5420 000 210
Centrifuge 5420 (EU-IVD) , non-refrigerated, with aerosol-tight Rotor FA-24x2, keypad, 230 V/50 – 60 Hz	5420 000 016

✎ Ordering information for other voltage options begins on page 450

Centrifuge 5424 R



CE*

* The Centrifuge 5424 R is designed for separating liquid substance mixtures with different densities, in particular, for processing and analyzing samples from the human body in in-vitro diagnostic applications to ensure that the in-vitro diagnostic device can be used according to its intended purpose. This centrifuge including components is an in-vitro diagnostic device according to Directive 98/79/EC of the European Parliament and the Council dated October 27, 1998.

Ordering information

Description	Order no.
Centrifuge 5424 R (EU-IVD), refrigerated, without rotor, keypad, 230 V/50 – 60 Hz	5404 000 219
Centrifuge 5424 R (EU-IVD), refrigerated, without rotor, rotary knobs, 230 V/50 – 60 Hz	5404 000 618
Centrifuge 5424 R (EU-IVD), refrigerated, with Rotor FA-45-24-11, keypad, 230 V/50 – 60 Hz	5404 000 014
Centrifuge 5424 R (EU-IVD), refrigerated, with Rotor FA-45-24-11, rotary knobs, 230 V/50 – 60 Hz	5404 000 413

Ordering information for other voltage options begins on page 450

Centrifuge 5425



CE*

* The Centrifuge 5425 is designed for separating liquid substance mixtures with different densities, in particular, for processing and analyzing samples from the human body in in-vitro diagnostic applications to ensure that the in-vitro diagnostic device can be used according to its intended purpose. This centrifuge including components is an in-vitro diagnostic device according to Directive 98/79/EC of the European Parliament and the Council dated October 27, 1998.

Ordering information

Description	Order no.
Centrifuge 5425 (EU-IVD), non-refrigerated, without rotor, keypad, 230 V/50 – 60 Hz	5405 000 212
Centrifuge 5425 (EU-IVD), non-refrigerated, without rotor, rotary knobs, 230 V/50 – 60 Hz	5405 000 611
Centrifuge 5425 (EU-IVD), non-refrigerated, with Rotor FA-24x2, keypad, 230 V/50 – 60 Hz	5405 000 018
Centrifuge 5425 (EU-IVD), non-refrigerated, with Rotor FA-24x2, rotary knobs, 230 V/50 – 60 Hz	5405 000 417

Ordering information for other voltage options begins on page 450

Centrifuge 5427 R



CE*

* The Centrifuge 5427 R is designed for separating liquid substance mixtures with different densities, in particular, for processing and analyzing samples from the human body in in-vitro diagnostic applications to ensure that the in-vitro diagnostic device can be used according to its intended purpose. This centrifuge including components is an in-vitro diagnostic device according to Directive 98/79/EC of the European Parliament and the Council dated October 27, 1998.

Ordering information

Description	Order no.
Centrifuge 5427 R (EU-IVD), refrigerated, without rotor, rotary knobs, 230 V/50 – 60 Hz	5409 000 012
Centrifuge 5427 R (EU-IVD), refrigerated, with Rotor FA-45-12-17, rotary knobs, 230 V/50 – 60 Hz	5409 000 632
Centrifuge 5427 R (EU-IVD), refrigerated, with Rotor FA-45-30-11, rotary knobs, 230 V/50 – 60 Hz	5409 000 535
Centrifuge 5427 R (EU-IVD), refrigerated, with Rotor FA-45-48-11, rotary knobs, 230 V/50 – 60 Hz	5409 000 217

✎ Ordering information for other voltage options begins on page 450

Centrifuge 5430/5430 R



CE*

* The Centrifuge 5430/5430 R is designed for separating liquid substance mixtures with different densities, in particular, for processing and analyzing samples from the human body in in-vitro diagnostic applications to ensure that the in-vitro diagnostic device can be used according to its intended purpose. This centrifuge including components is an in-vitro diagnostic device according to Directive 98/79/EC of the European Parliament and the Council dated October 27, 1998.

Ordering information

Description	Order no.
Centrifuge 5430 (EU-IVD), non-refrigerated, without rotor, keypad, 230 V/50 – 60 Hz	5427 000 011
Centrifuge 5430 (EU-IVD), non-refrigerated, without rotor, rotary knobs, 230 V/50 – 60 Hz	5427 000 615
Centrifuge 5430 (EU-IVD), non-refrigerated, with Rotor FA-45-30-11 incl. rotor lid, keypad, 230 V/50 – 60 Hz	5427 000 216
Centrifuge 5430 (EU-IVD), non-refrigerated, with Rotor FA-45-30-11 incl. rotor lid, rotary knobs, 230 V/50 – 60 Hz	5427 000 410
Centrifuge 5430 R (EU-IVD), refrigerated, without rotor, keypad, 230 V/50 – 60 Hz	5428 000 210
Centrifuge 5430 R (EU-IVD), refrigerated, without rotor, rotary knobs, 230 V/50 – 60 Hz	5428 000 619
Centrifuge 5430 R (EU-IVD), refrigerated, with Rotor FA-45-30-11 incl. rotor lid, keypad, 230 V/50 – 60 Hz	5428 000 015
Centrifuge 5430 R (EU-IVD), refrigerated, with Rotor FA-45-30-11 incl. rotor lid, rotary knobs, 230 V/50 – 60 Hz	5428 000 414

✎ Ordering information for other voltage options begins on page 450

Centrifuge 5702/5702 R/5702 RH



* The Centrifuge 5702/5702 R/5702 RH is designed for separating liquid substance mixtures with different densities, in particular, for processing and analyzing samples from the human body in in-vitro diagnostic applications to ensure that the in-vitro diagnostic device can be used according to its intended purpose. This centrifuge including components is an in-vitro diagnostic device according to Directive 98/79/EC of the European Parliament and the Council dated October 27, 1998.

Ordering information

Description	Order no.
Centrifuge 5702 (EU-IVD) , non-refrigerated, without rotor, rotary knobs, 230 V/50 – 60 Hz	5702 000 019
Centrifuge 5702 (EU-IVD) , non-refrigerated, with Rotor A-4-38 incl. adapters for 15/50 mL conical tubes, 2 sets of 2 adapters, rotary knobs, 230 V/50 – 60 Hz	5702 000 329
Centrifuge 5702 R (EU-IVD) , refrigerated, without rotor, rotary knobs, 230 V/50 – 60 Hz	5703 000 012
Centrifuge 5702 R (EU-IVD) , refrigerated, with Rotor A-4-38 incl. adapters for 13/16 mm blood collection tubes, 2 sets of 2 adapters, rotary knobs, 230 V/50 – 60 Hz	5703 000 322
Centrifuge 5702 R (EU-IVD) , refrigerated, with Rotor A-4-38 incl. adapters for 15/50 mL conical tubes, 2 sets of 2 adapters, rotary knobs, 230 V/50 – 60 Hz	5703 000 420
Centrifuge 5702 RH (EU-IVD) , refrigerated/heated, without rotor, rotary knobs, 230 V/50 – 60 Hz	5704 000 016

⚡ Ordering information for other voltage options begins on page 450

Centrifuge 5804/5804 R and 5810/5810 R



* The Centrifuge 5804/5804 R and 5810/5810 R is designed for separating liquid substance mixtures with different densities, in particular, for processing and analyzing samples from the human body in in-vitro diagnostic applications to ensure that the in-vitro diagnostic device can be used according to its intended purpose. This centrifuge including components is an in-vitro diagnostic device according to Directive 98/79/EC of the European Parliament and the Council dated October 27, 1998.

Ordering information

Description	Order no.
Centrifuge 5804 (EU-IVD) , non-refrigerated, without rotor, keypad, 230 V/50 – 60 Hz	5804 000 013
Centrifuge 5804 R (EU-IVD) , refrigerated, without rotor, keypad, 230 V/50 – 60 Hz	5805 000 017
Centrifuge 5810 (EU-IVD) , non-refrigerated, without rotor, keypad, 230 V/50 – 60 Hz	5810 000 017
Centrifuge 5810 R (EU-IVD) , refrigerated, without rotor, keypad, 230 V/50 – 60 Hz	5811 000 010

⚡ Ordering information for other voltage options begins on page 450

Centrifuge Packages

Ordering information		
Description	Max. capacity per rotor	Order no.
Centrifuge 5702 (EU-IVD) , non-refrigerated, with Rotor A-4-38 incl. adapters for 15/50 mL conical tubes, 2 sets of 2 adapters, rotary knobs, 230 V/50 – 60 Hz	8 × 15 mL/4 × 50 mL	5702 000 329
Centrifuge 5702 R (EU-IVD) , refrigerated, with Rotor A-4-38 incl. adapters for 15/50 mL conical tubes, 2 sets of 2 adapters, rotary knobs, 230 V/50 – 60 Hz	8 × 15 mL/4 × 50 mL	5703 000 420
Centrifuge 5804 (EU-IVD) , non-refrigerated, with Rotor A-4-44 incl. adapters for 15/50 mL conical tubes, keypad, 230 V/50 – 60 Hz	16 × 15 mL/4 × 50 mL	5804 000 323
Centrifuge 5804 R (EU-IVD) , refrigerated, with Rotor A-4-44 incl. adapters for 15/50 mL conical tubes, keypad, 230 V/50 – 60 Hz	16 × 15 mL/4 × 50 mL	5805 000 327
Centrifuge 5804 (EU-IVD) , non-refrigerated, with Rotor S-4-72 incl. adapters for 15/50 mL conical tubes, keypad, 230 V/50 – 60 Hz	32 × 15 mL/16 × 50 mL	5804 000 528
Centrifuge 5804 R (EU-IVD) , refrigerated, with Rotor S-4-72 incl. adapters for 15/50 mL conical tubes, keypad, 230 V/50 – 60 Hz	32 × 15 mL/16 × 50 mL	5805 000 629
Centrifuge 5810 (EU-IVD) , non-refrigerated, with Rotor A-4-62 incl. adapters for 15/50 mL conical tubes, keypad, 230 V/50 – 60 Hz	36 × 15 mL/16 × 50 mL	5810 000 327
Centrifuge 5810 R (EU-IVD) , refrigerated, with Rotor A-4-62 incl. adapters for 15/50 mL conical tubes, keypad, 230 V/50 – 60 Hz	36 × 15 mL/16 × 50 mL	5811 000 320
Centrifuge 5810 (EU-IVD) , non-refrigerated, with Rotor A-4-81 incl. adapters for 15/50 mL conical tubes, keypad, 230 V/50 – 60 Hz	48 × 15 mL/20 × 50 mL	5810 000 424
Centrifuge 5810 R (EU-IVD) , refrigerated, with Rotor A-4-81 incl. adapters for 15/50 mL conical tubes, keypad, 230 V/50 – 60 Hz	48 × 15 mL/20 × 50 mL	5811 000 428
Centrifuge 5810 (EU-IVD) , non-refrigerated, with Rotor S-4-104 incl. adapters for 15/50 mL conical tubes, keypad, 230 V/50 – 60 Hz	56 × 15 mL/28 × 50 mL	5810 000 521
Centrifuge 5810 R (EU-IVD) , refrigerated, with Rotor S-4-104 incl. adapters for 15/50 mL conical tubes, keypad, 230 V/50 – 60 Hz	56 × 15 mL/28 × 50 mL	5811 000 622
Centrifuge 5810 (EU-IVD) , non-refrigerated, with Rotor S-4-104 incl. adapters for 13/16 mm round-bottom tubes, keypad, 230 V/50 – 60 Hz	92 × 13 mm/80 × 16 mm	5810 000 629
Centrifuge 5810 R (EU-IVD) , refrigerated, with Rotor S-4-104 incl. adapters for 13/16 mm round-bottom tubes, keypad, 230 V/50 – 60 Hz	92 × 13 mm/80 × 16 mm	5811 000 827

✂ Ordering information for other voltage options begins on page 450

Centrifuge 5910 R



CE*

* The Centrifuge 5910 R is designed for separating liquid substance mixtures with different densities, in particular, for processing and analyzing samples from the human body in in-vitro diagnostic applications to ensure that the in-vitro diagnostic device can be used according to its intended purpose. This centrifuge including components is an in-vitro diagnostic device according to Directive 98/79/EC of the European Parliament and the Council dated October 27, 1998.

Ordering information	
Description	Order no.
Centrifuge 5910 R (EU-IVD) , refrigerated, without rotor, 230 V/50 – 60 Hz	5942 000 016

✂ Ordering information for other voltage options begins on page 450

Centrifuge Packages

Ordering information		
Description	Max. capacity per rotor	Order no.
Centrifuge 5910 R (EU-IVD) , refrigerated, with Rotor S-4xUniversal, 230 V/50 – 60 Hz, incl. universal buckets and adapters for 5 mL/15 mL/50 mL conical tubes and plates ¹⁾	68 × 15 mL/36 × 50 mL	5942 000 318
Centrifuge 5910 R (EU-IVD) , refrigerated, with Rotor S-4xUniversal, 230 V/50 – 60 Hz, incl. universal buckets and adapters for 5 mL/15 mL/50 mL conical tubes, 175 mL – 250 mL bottles and plates	68 × 15 mL/28 × 50 mL	5942 000 210
Centrifuge 5910 R (EU-IVD) , refrigerated, with Rotor S-4x750, 230 V/50 – 60 Hz, incl. round buckets and adapters for 5 mL/15 mL/50 mL conical tubes	56 × 15 mL/28 × 50 mL	5942 000 512
Centrifuge 5910 R (EU-IVD) , refrigerated, with Rotor S-4x500, 230 V/50 – 60 Hz, incl. rectangular buckets and adapters for 15 mL/50 mL conical tubes	48 × 15 mL/20 × 50 mL	5942 000 610
Centrifuge 5910 R (EU-IVD) , refrigerated, with Rotor S-4x400, 230 V/50 – 60 Hz, incl. round buckets and adapters for 5 mL/15 mL/50 mL conical tubes	28 × 15 mL/16 × 50 mL	5942 000 717
Centrifuge 5910 R (EU-IVD) , refrigerated, with Rotor S-4xUniversal, 230 V/50 – 60 Hz, incl. universal buckets and adapters for round-bottom tubes with diameter 13/16 mm	120 × 13 mm/104 × 16 mm	5942 000 415

¹⁾ When used with aerosol-tight caps the max. capacity is reduced to 20 × 50 mL (5 × 50 mL per bucket)

✂ Ordering information for other voltage options begins on page 450

Centrifuge 5920 R



As awarded by The Chicago Athenaeum: Museum of Architecture and Design.



CE*

* The Centrifuge 5920 R is designed for separating liquid substance mixtures with different densities, in particular, for processing and analyzing samples from the human body in in-vitro diagnostic applications to ensure that the in-vitro diagnostic device can be used according to its intended purpose. This centrifuge including components is an in-vitro diagnostic device according to Directive 98/79/EC of the European Parliament and the Council dated October 27, 1998.

Ordering information

Description	Order no.
Centrifuge 5920 R (EU-IVD), refrigerated, 230 V/50 – 60 Hz	5948 000 018

Ordering information for other voltage options begins on page 450

Centrifuge Packages

Ordering information

Description	Max. capacity per rotor	Order no.
Centrifuge 5920 R (EU-IVD), refrigerated, with Rotor S-4x1000, 230 V/50 – 60 Hz, incl. high-capacity buckets and adapters for 15 mL/50 mL conical tubes	108 x 15 mL/52 x 50 mL	5948 000 212
Centrifuge 5920 R (EU-IVD), refrigerated, with Rotor S-4xUniversal-Large, 230 V/50 – 60 Hz, incl. universal buckets and adapters for 15 mL/50 mL conical tubes	96 x 15 mL/40 x 50 mL	5948 000 913
Centrifuge 5920 R (EU-IVD), refrigerated, with Rotor S-4x1000, 230 V/50 – 60 Hz, incl. plate/tube buckets and adapters for 15 mL/50 mL conical tubes	88 x 15 mL/40 x 50 mL	5948 000 417
Centrifuge 5920 R (EU-IVD), refrigerated, with Rotor S-4x1000, 230 V/50 – 60 Hz, incl. round buckets and adapters for 15 mL/50 mL conical tubes	56 x 15 mL/28 x 50 mL	5948 000 310
Centrifuge 5920 R (EU-IVD), refrigerated, with Rotor S-4xUniversal-Large, 230 V/50 – 60 Hz, incl. universal buckets and adapters for round-bottom tubes with diameter 13/16 mm	196 x 13 mm/148 x 16 mm	5948 000 816

Ordering information for other voltage options begins on page 450

Cell Handling

TransferMan® 4m

Description

You are facing an increasing number of ICSI-cycles per day with the same high fertilization/blastocyst rates of precious oocytes? Did you ever experience work-related stress or pain in arms, neck or back due to unergonomic (setup of) micromanipulators?

The TransferMan® 4m was designed to solve main challenges of modern IVF-labs to increase fertilization/blastocyst rates, reproducibility, throughput, and to minimize work-related stress for the user. Request a personal on-site demo to compare easy, ergonomic handling and excellent performance of the TransferMan® 4m to your current solution - convince yourself.

CE*



Applications

- > Micromanipulation of oocytes or embryos of the early developmental stages (e.g. ICSI, hatching, etc.)
- > Combined with CellTram® 4m perfectly suited for biopsies (e.g. trophectoderm, blastocysts, blastocoelic fluid), TESE or IMSI

See how fast capillaries can be changed in this video



www.eppendorf.com/fast-capillary-exchange

* The TransferMan® 4m was designed and manufactured for the purpose of intracytoplasmic sperm injection (ICSI) within the context of human reproductive medicine. Therefore the TransferMan® 4m is a medical product in accordance with the guideline 93/42/EEC of the European Union.

Higher fertilization/blastocyst rates

- > Less traumatic injections by minimized lesion holes with Y motor off function (100% movement in x-direction only)
- > Real-time feeling, direct mode for precise and dynamic mode for fast movements - with the unique DualSpeed joystick

Increased workflow-speed

- > Fast capillary exchange and re-positioning without re-focusing within a few seconds by home function, swivel joint and reproducible positioning of the capillary inside the holder (no exchange of the capillary holder)
- > Fast automatic switch between stored capillary positions in and above the medium droplet
- > Adjustable speed control of the joystick to fit meets of training centers, as well as high-throughput clinics

Reduced work-related stress and pain - Eppendorf PhysioCare® concept:

- > The hand can rest relaxed on the panel without accidental activation of buttons
- > „One joystick“-concept omits the need to switch between several control elements

- > Easy training of beginners with intuitive „one-joystick“-concept
- > Programmable Z-axis limit to prevent capillary breakage

TransferMan® 4m



Workstation for intracytoplasmic sperm injection (ICSI).
TransferMan 4m mounted on Olympus IX73

Technical specifications	
Model	TransferMan 4m
Motor module set	
Max. traveling distance	≥20 mm in X, Y, Z and X/Z direction
Weight (complete)	2,15 kg
Stepper motor	X-, Y-, Z-module
Single module (X, Y, Z)	
Step size	< 20 nm (computational resolution)
Speed	0 – 10,000 µm/s
Mechanical adjustability	>80 mm
Dimensions	129 × 51 × 36 mm
Weight	570 g
Swivel joint	
Direction of rotation	-45° to +90°
Capillary exchange	Direction of rotation: forward
Sample replacement	Direction of rotation: backward
Angle head	
Operating angle	0° – 90°
Control board	
Control	Joystick (proportional and dynamic kinetics)
Speed modes	coarse, fine, x-fine
Speed control	Proportional and dynamic kinetics
Dimensions (W x H x D)	205 × 288 × 152 mm
Weight	1.8 kg

Ordering information

Description	Order no.
TransferMan® 4m , micromanipulator with DualSpeed™ joystick for direct and dynamic movement control The TransferMan® 4m was designed and manufactured for the purpose of intracytoplasmic sperm injection (ICSI) within the context of human reproductive medicine. Therefore the TransferMan® 4m is a medical product in accordance with the guideline 93/42/EEC of the European Union.	5191 000 015



Smooth Operator – The Eppendorf system speeds up workflow with high cell survival rates



A fast capillary exchange within a few seconds is ensured via home function, swivel joint and a reproducible positioning of the capillary inside the holder.

CellTram® 4m Air/Oil

Description

The CellTram 4m Air and CellTram 4m Oil are manual microinjectors specially designed for various ART-applications. The CellTram 4m Air is a pneumatic injector for oil-free micromanipulation and gentle holding of oocytes and embryos. Due to its pressure performance, it is also highly suitable for uptake and injection of cells (e.g., sperm). For this application, its performance is comparable to that of oil-filled injectors. The CellTram 4m Oil is a hydraulic, oil-filled microinjector optimized for precise control of high pressures, e.g. for biopsies, leakage-free work and easy oil filling.



CE*

* The CellTram 4m was designed and manufactured for injection and aspiration of cells or cellular parts in the context of ex-vivo micromanipulations in combination with suitable microcapillaries in the area of human reproductive medicine. Therefore the CellTram 4m is a medical product in accordance with the guideline 93/42/EEG of the European Union.

Product features

- > Non-hydraulic system for oil-free manipulation but also injection of cells (CellTram 4m Air)
- > Piston position scale enables setting of air volume and injection characteristics according to individual needs (CellTram 4m Air)
- > Improved oil-filling system for minimal interruption of the workflow (CellTram 4m Oil)
- > Coarse and fine drive for precise and intuitive sample control
- > Improved rotary knob design for better handling and easier cleaning
- > Capillary holder 4 with markings for easier positioning and defined capillary position
- > New grip head 4 system for simple capillary change and higher user safety
- > Position indicators and marking for in/out to reduce risk of user errors
- > Heavy, stable, nonslip base plate
- > Highly reliable performance with minimal maintenance

Applications

- > Intracytoplasmic sperm injection (ICSI)
- > Gentle holding of cells or embryos (e.g., oocytes or blastocysts)
- > Uptake and microinjection of small cells (e.g., sperm)
- > Transfer of suspension cells or organelles
- > Removal of cells (e.g., for embryo biopsies)

CellTram® 4m Air/Oil



CellTram 4m Air: Pressure responsiveness for various applications can be adjusted by different piston positions



CellTram 4m Oil: The new oil-filling system helps avoid oil-spilling and facilitates the filling process

Technical specifications		
Model	CellTram 4m Air	CellTram 4m Oil
Cylinder volume	10 mL	1,000 µL
Max. pressure	3,000 hPa	20,000 hPa
Min. adjustable volume	< 100 nL	< 1.5 nL
Pressure generation	Cylinder/piston system, air-filled	Cylinder/piston system, oil-filled
Volume change per revolution	60 µL/600 µL	1 µL/10 µL

Ordering information

Description	Order no.
CellTram® 4m Air , manual pneumatic microinjector, with gears 1:1 and 1:10, for holding and injection, The CellTram 4m was designed and manufactured for injection and aspiration of cells or cellular parts in the context of ex-vivo micromanipulations in combination with suitable microcapillaries in the area of human reproductive medicine. Therefore the CellTram 4m is a medical product in accordance with the guideline 93/42/EWG of the European Union.	5196 000 021
CellTram® 4m Oil , manual hydraulic microinjector, with gears 1:1 and 1:10, for holding and injection, The CellTram 4m was designed and manufactured for injection and aspiration of cells or cellular parts in the context of ex-vivo micromanipulations in combination with suitable microcapillaries in the area of human reproductive medicine. Therefore the CellTram 4m is a medical product in accordance with the guideline 93/42/EWG of the European Union.	5196 000 048
Capillary holder 4 , for mounting microcapillaries	5196 081 005
Filling and Cleaning set , incl. filling tube, Luer lock adapter, 2 syringes for CellTram® 4	5196 088 000
Grip head set 4 size 0 , for microcapillaries with outer diameter 1.0 to 1.1 mm (1 only)	5196 082 001
Grip head set 4 size 1 , for microcapillaries with outer diameter 1.2 to 1.3 mm (1 only)	5196 083 008
Grip head set 4 size 2 , for microcapillaries with outer diameter 1.4 to 1.5 mm (1 only)	5196 084 004
Grip head set 4 size 3 , for microcapillaries with outer diameter 0.7 to 0.9 mm (1 only)	5196 085 000
Injection tube Air , white ring mark, I.D. 0.5 mm, length 1.3 m	5196 061 004
Injection tube Oil , blue ring mark, I.D. 1.0 mm, length 1.3 m	5196 089 006
O-ring set 4 , incl. 10 o-rings large, 10 o-rings small, 2 distance sleeves, o-ring removal tool for grip head set 4	5196 086 007

Technical specifications subject to change.

Index

General Lab Products

15 and 50 mL conical Tubes	128	Biopsy Tips	305
25 mL conical Tubes	126	BioSpectrometer	235 - 238
3810X Tubes	121	Bottle Top Dispensers	84
5.0 mL Tubes	124	Boxes for storage	288
Accessories for Universal platforms	350	Bundles 5910 R/5920 R	198
Accessories Freezers	278, 279	Cap Strips	263, 265
Accessories Incubators	333	Capillaries for Piezo-assisted Cell Transfer	304
Accessories Tubes	140	Carousels, charger stands, wall mounting devices	44
Adapter for 0.2 mL PCR Tubes	147	CCCadvanced® FN1 motifs	317
Adapter for 0.8 mL BD Microtainer® and 0.5 mL tubes	147	Cell Culture Consumables	310 - 316
Adapter for S-4x1000 high-capacity buckets	214	Cell Culture Dishes	314
Adapter for S-4x1000 plate/tube buckets	216	Cell culture flask adapter	179
Adapter for S-4xUniversal-Large	210, 212	Cell Culture Flasks	315
Adapters for Rotor A-4-38 rectangular buckets	166	Cell Culture Plates	311 - 213
Adapters for Rotor A-4-38 round buckets	164	Cell Handling	291
Adapters for Rotor A-4-44	188	Cell Imaging Consumables	319 - 321
Adapters for Rotor A-4-62	184	Cell Manipulation	290
Adapters for Rotor A-4-81	182	Cell Manipulation Performance Plans	394
Adapters for Rotor F-34-6-38	190	Cell Transfer Capillaries	303
Adapters for Rotor FA-45-6-30	192	CellTram® 4r Air/Oil	298
Adapters for Rotor FA-6x50	224	CellXpert® C170	330
Adapters for Rotor S-4-104	180	CellXpert® C170i	326 - 329
Adapters for Rotor S-4-72	186	Centrifuge 5418 R	147
Adapters for Rotor S-4x1000 round buckets	218	Centrifuge 5420	148
Adapters for Rotor S-4x400	206	Centrifuge 5424 R	149
Adapters for Rotor S-4x500	204	Centrifuge 5425	151
Adapters for Rotor S-4x750	208	Centrifuge 5427 R	153
Adapters for Rotor S-4xUniversal	202	Centrifuge 5430/5430 R	156
Adapters Micromanipulation Systems	294	Centrifuge 5702/5702 R/5702 RH	162
Advanced Rotor Design – Fixed-Angle Rotors	176, 220	Centrifuge 5804/5804 R and 5810/5810 R	168, 170
Advanced Rotor Design – Swing-Bucket Rotors	174	Centrifuge 5910 R	196
Antivibration Pad	295	Centrifuge 5910 R and Centrifuge 5920 R	194
Assay/Reader Microplates	132	Centrifuge 5920 R	197
Automated Liquid Handling	88	Centrifuge Packages	172
BioBLU® Single-Use Vessels	370	Centrifuge Packages 5910 R	198
BioFlo® 120	367	Centrifuge Packages 5920 R	199
BioFlo® 320	367	Centrifuge Performance Plans	386
BioFlo® 510 & CelliGen 510	368	Chart Recorder	279
BioFlo® 610	368	Chest Freezers	278
BioFlo® Pro	369	Clamps and Accessories for Universal Platforms	350
Biological Shaker Performance Plans	398	CO ₂ and LN ₂ Back-up System	279
Biophotometer D30	234	CO ₂ Incubator Galaxy® 48 R	324
BioPhotometer D30 Reference Filter Set	244	CO ₂ Incubator Performance Plans	396
Bioprocess Performance Plans	402	CO ₂ Incubators Accessories	333

General Lab Products

Combination of epT.I.P.S.® pipette tips with Reference 2 pipettes	66	epMotion® Application Implementation	382
Combination of epT.I.P.S.® pipette tips with Research plus/Research plus Move It® pipettes	64	epMotion® Height adapters	103
Combination of epT.I.P.S.® pipette tips with Xplorer/Xplorer plus and Xplorer plus Move It® pipettes	68	epMotion® Liquid dispensing	99
Combitips advanced®	77 - 79	epMotion® Liquid waste	103
Concentrator plus	228	epMotion® Performance Plans	380
Conical Tubes 15 mL and 50 mL	128	epMotion® Pipetting tools	99
Conical Tubes 25 mL	126	epMotion® Plate adapter	101
Consumables epMotion®	96, 384	epMotion® Plate gripper	101
Consumables for automated pipetting	96, 97, 384	epMotion® Racks for tubes	100, 102
Consumables PCR	258, 262	epMotion® ReservoirRacks and Modules	100
Correct Handling of Difficult Liquids	70, 73	epMotion® Space for plates	101
CycleManager X50 Software	249	epMotion® Surface level	103
Cycler	248	epMotion® Thermal racks	101
DASware® access	372	epMotion® Thermoracks and Plate Accessories	101
DASware® analyze	372	epMotion® Tuberacks, Adapters and Vacuum Modules	102
DASware® connect	372	epMotion® Upgrades and software automated pipetting	98
DASware® design	372	epMotion® Vacuum	102
DASware® discover	372	epMotion® Waste Accessories	103
Deepwell Plates	134	epMotion® Waste bags	103
Detection	232- 254	Eppendorf Assay/Reader Microplates	132
Device Hardware Upgrades and Software	98	Eppendorf BioPhotometer® D30	234
Dispenser M4	70	Eppendorf BioPhotometer® D30 Reference Filter Set	244
Dispenser Multipipette E3/E3x	73 - 75	Eppendorf Bioprocess Software	372
Dispensing tools	99	Eppendorf BioSpectrometer® basic	235
DNA LoBind	138, 139	Eppendorf BioSpectrometer® fluorescence	237
DNA LoBind Plates	138	Eppendorf BioSpectrometer® kinetic	236
DNA LoBind Tubes	139	Eppendorf BioSpectrometer® Reference Filter Sets	245
Dualfilter tips	53, 54	Eppendorf Cell Culture Consumables	310, 316
Dualfilter tips SealMax	55	Eppendorf Cell Culture Dishes	314
Easypet® 3	81	Eppendorf Cell Culture Flasks	315
Electronic dispenser	73, 75	Eppendorf Cell Culture Plates	311, 312
Electronic Pipettes	37, 39	Eppendorf Cell Imaging Consumables	319, 320
ep Dualfilter T.I.P.S.®	53	Eppendorf Conical Tubes	193, 225
ep Dualfilter T.I.P.S.® 384	54	Eppendorf Conical Tubes 15 mL and 50 mL	128
ep Dualfilter T.I.P.S.® SealMax	55	Eppendorf Conical Tubes 25 mL	126
epBlue™ Software	98	Eppendorf CryoStorage Vials	281
epMotion® 5070/5070f	89	Eppendorf Deepwell Plates	134
epMotion® 5073i/5073m	90	Eppendorf Eporator®	290
epMotion® 5073m NGS solution	94	Eppendorf Fast PCR Tube Strips	261
epMotion® 5075l	91	Eppendorf High-Efficiency ULT Upright Freezers	272, 274
epMotion® 5075v/5075m	92	Eppendorf Microplates	130
epMotion® 5075v/5075vt	93	Eppendorf PCR Tube Strips	262
epMotion® 96 Accessories	101	Eppendorf PCR Tubes	262
epMotion® 96 and 96xl	88	Eppendorf PCR Tubes, 0.5 mL	263
epMotion® 96 Performance Plans	378	Eppendorf PiezoXpert®	296
		Eppendorf Pipette Holder System	44

Eppendorf Purity Grades for Tips	46	Excella® E25/E25R	344
Eppendorf Purity Grades for Tubes and Plates	120	FemtoJet® 4i	301
Eppendorf RackScan	283	FemtoJet® 4i and FemtoJet® 4x	300, 302
Eppendorf Reference® 2	32, 34	FemtoJet® 4x	301
Eppendorf Research® plus	26, 28, 30	Film	265
Eppendorf Research® plus 3-pack	31	Fixed-Angle Rotors 59xx Family - Overview	220
Eppendorf Research® plus and Eppendorf Xplorer® plus	41, 42	Foil	265
Eppendorf Safe-Lock Tubes	122	Freezer Accessories	278, 279
Eppendorf SafeCode system	280	Freezer Boxes Dividers	289
Eppendorf Serological Pipets	83	Freezer Cardboard Storage Boxes	288
Eppendorf SmartBlock™	113, 114	Freezer Racks	284, 286
Eppendorf Storage Boxes	288	Freezers	266 - 289
Eppendorf ThermoMixer® C	110	Galaxy® 48 R	324
Eppendorf ThermoMixer® F	116	GELoader®	50
Eppendorf ThermoStat™ C	112	Hardware hub VisioNize®	277
Eppendorf ThermoTop®	115	Heat Sealing Film and Heat Sealing Foil	264
Eppendorf Tip-tub	31	HeatSealer	257
Eppendorf Top Buret™	86	HEF ULT Freezers	272 - 278
Eppendorf TrackIT	80	Holding Capillaries	304
Eppendorf Tubes® 3810X	121	Incubator shaker Excella® E24/E24R	345
Eppendorf Tubes® 5.0 mL	124	Incubator shaker Excella® E25/E25R	344
Eppendorf twin.tec® PCR Plates	258, 260	Incubator shaker Innova® 40/40R	343
Eppendorf twin.tec® real-time PCR Plates	261	Incubator shaker Innova® 42/42R	342
Eppendorf ULT Chest Freezers	278	Incubator shaker Innova® 43/43R	341
Eppendorf ULT Freezers	276	Incubator shaker Innova® 44/44R	340
Eppendorf ULT Upright Freezers	278	Incubator shaker S41i	331, 332
Eppendorf UVette®	242	Incubators Accessories	333
Eppendorf Varipette	80	InjectMan® 4	292
Eppendorf Vis Cuvettes	243	Innova® Freezers	278
Eppendorf Xplorer®	36	Innova® Upright Freezers	278
Eppendorf Xplorer® plus	38, 40	Innova® 2000	349
Eppendorf Xplorer®/Eppendorf Xplorer® plus	35	Innova® 2050	349
Eppendorf µCuvette® G1.0	241	Innova® 2100	348
epServices	374	Innova® 2150	348
epT.I.P.S.®	48, 50	Innova® 2300	347
epT.I.P.S.® 384	51	Innova® 2350	347
epT.I.P.S.® Box/epT.I.P.S.® Set	49	Innova® 40/40R	343
epT.I.P.S.® Long	52	Innova® 42/42R	342
epT.I.P.S.® LoRetention	56	Innova® 43/43R	341
epT.I.P.S.® Motion as Reload System	96	Innova® 44/44R	340
epT.I.P.S.® Motion pipette tips	97	Innova® 5050/5051 Rack Systems	350
epT.I.P.S.® Racks	49	Innova® S44i	338
epT.I.P.S.® Reloads	50	IsoRack	118
epT.I.P.S.® Singles	49	IsoRack adapter	179
epT.I.P.S.® Standard	49	IsoTherm-System®	118
Exceedingly Versatile – Bench Scale Fermentors and Bioreactors	367	LoBind Plates	136, 138
Excella® E24/E24R	345	LoBind Tubes	137, 139
		LoRetention tips	56

General Lab Products

Maintenance and Certification	375
Manual Dispenser Multipipette	70
Manual Pipettes	26 - 35
Masterclear® Cap Strips and real-time PCR Tube Strips	264
Masterclear® real-time PCR Film	265
Mastercycler® nexus	252, 254
Mastercycler® nexus X2	253
Mastercycler® Performance Plans	390
Mastercycler® X50	248
Microcentrifuges	146
Microinjection Capillaries	306
Microinjection system	300
Microloader™	50, 307
Micromanipulation Systems	292
Microplates	130
Microscope Adapters for Micromanipulation Systems	294
Mini Bioreactor System	366
MiniSpin®/MiniSpin® plus	146
Mixer	110, 117
MixMate®	117
Move It® - Adjustable Multichannel Pipettes	41, 42
Multipipette® E3/E3x	73, 74
Multipipette® M4	70, 72
New Brunswick™ Excella® E24/E24R	345
New Brunswick™ Excella® E25/E25R	344
New Brunswick™ Innova® 2000	349
New Brunswick™ Innova® 2050	349
New Brunswick™ Innova® 2100	348
New Brunswick™ Innova® 2150	348
New Brunswick™ Innova® 2300	347
New Brunswick™ Innova® 2350	347
New Brunswick™ Innova® 40/40R	343
New Brunswick™ Innova® 42/42R	342
New Brunswick™ Innova® 43/43R	341
New Brunswick™ Innova® 44/44R	340
New Brunswick™ Innova® 5050/5051 Racking Systems	350
New Brunswick™ S41i	331, 332
Open Air Shaker Innova® 2000	349
Open Air Shakers	346
Overview of Swing-Bucket Rotors 58xx Family	174
Overview of the Main Fixed-Angle Rotors 58xx Family	176
Packages Centrifuges 5910 R/5920 R	198
Parallel Bioprocessing for Unparalleled Results – Small-Scale Systems	366
Parallel Bioreactor Systems	366
PCR	248

PCR cap strips	263
PCR Film	265
PCR Film (self-adhesive) and PCR Foil (self-adhesive)	265
PCR plates	260, 262
PCR Rack	265
PCR Tube Strips	261, 263 - 265
PCR Tubes	263 - 264
PCR-Cooler	118
Photometry Performance Plans	388
PiezoXpert	296
Pipet Helper®	82
Pipette controller	81
Pipette Holder Systems	44
Pipette Performance Plans	376
Pipette tips	48 - 62
Pipette Tips Dualfilter	53, 54
Pipette tips epT.I.P.S.® Motion	96,97
Positive-displacement pipettes	80
Printer DPU-S445	243
Protein LoBind	137
Protein LoBind Plates	136
Protein LoBind Tubes	137
Purity Grades	46, 120
Racks for Freezer steel and aluminum	284, 286
RackScan	283
Reference Filter Set for Biospectrometer fluorescence	245
Reference Filter Sets	244
Reference Filter Sets for Biospectrometer	245
Reference 2	32, 34
Reference 2, 3-pack	34
Research plus	26, 28, 30
Research plus 3-pack	31
Research plus Move It™	41
Reservoir epMotion®	100
RFID Reader/Software	80
Rolling Cabinet	171
Rotor 96x0.2-PCR	152
Rotor A-2-DWP	179
Rotor A-2-DWP-AT	178
Rotor A-2-MTP	158
Rotor A-2-VC	231
Rotor A-4-38 with rectangular buckets	166
Rotor A-4-38 with round buckets	164
Rotor A-4-44	188
Rotor A-4-62	184
Rotor A-4-81	182

Rotor A-8-17	167
Rotor F-32x0.2-PCR	152
Rotor F-32x0.2-PCR for Centrifuge 5420	148
Rotor F-34-6-38	190
Rotor F-35-30-17	167
Rotor F-35-6-30	158, 231
Rotor F-45-12-11	146
Rotor F-45-18-11-Kit	150
Rotor F-45-18-17-Cryo	158, 167
Rotor F-45-24-11	167
Rotor F-45-30-11	154, 158
Rotor F-45-32-5-PCR	150
Rotor F-45-48-11	154, 157, 230
Rotor F-45-48-5-PCR	155
Rotor F-45-64-5-PCR	158
Rotor F-45-8-17	231
Rotor F-48x15	227
Rotor F-55-16-5 PCR	146
Rotor FA-10x5	152
Rotor FA-18x2 Kit	152
Rotor FA-20x5	226
Rotor FA-24x2 for Centrifuge 5420	148
Rotor FA-24x2-PTFE	152
Rotor FA-30x2	227
Rotor FA-45-12-17	155
Rotor FA-45-16-17	157
Rotor FA-45-18-11	147
Rotor FA-45-24-11	150, 154
Rotor FA-45-24-11-HS	158
Rotor FA-45-24-11-Kit	154, 157
Rotor FA-45-24-11-Special	150
Rotor FA-45-30-11	154, 157
Rotor FA-45-48-11	154, 157
Rotor FA-45-6-30	192
Rotor FA-48x2	226
Rotor FA-6x50	224
Rotor S-24-11-AT	155, 157
Rotor S-4-104	180
Rotor S-4-72	186
Rotor S-4x1000	214, 216
Rotor S-4x1000 round buckets	218
Rotor S-4x400	206
Rotor S-4x500	204
Rotor S-4x750	208
Rotor S-4xUniversal	202
Rotor S-4xUniversal-Large	210, 212
Rotors FA-24x2	152

Rotors for 58xx Family	178 - 192
Rotors for 5910 R	202 - 206, 227
Rotors for 5910 R/5920 R	208, 222 - 226
Rotors for 5920 R	210 -218
Rotors for Centrifuge 5424 R	150
Rotors for Centrifuge 5425	152
Rotors for Centrifuge 5427 R	154
Rotors for Centrifuge 5430/5430 R	157 - 159
Rotors for Centrifuge 5702/5702 R/5702 RH	164, 166
Rotors for Centrifuge 5810 and 5810 R	180 - 184
Rotors for Concentrator plus	230
S41i Incubator Shaker Performance Plans	400
Safe-Lock Tubes	122
SafeCode™ system	282
Sample Handling	105
Seminars and Training	375
Serological Pipets	83
SmartBlock	113,114
SmartExtender	111
Software for automated Pipetting	98
Special Tips	50, 63, 64
Stem Cells	360
Sterilizable-in-Place Fermentors and Bioreactors	368
Storage Boxes	288
Storage reaction plates	130
Swing-Bucket Rotors 59xx Family – Overview	200
Technical Service	375
Technical Specification Mastercycler® nexus	254
Technical Specification Mastercycler® nexus X2	256
Technical Specification Mastercycler® X50	250
Technical Specification Microcentrifuges	160
Temperature Control and Mixing Performance Plans	384
Temperature Verification System T6 - Multi Channel	251
Thermal Printer DPU-S445	243
ThermoMixer C	110
ThermoMixer F	116
ThermoStat™ C	112
ThermoTop	115
Tips	48, 51
Tips for 16- and 24-Channel Pipettes	64
Tips LoRetention	56
Tips SealMax	55
Top Buret	86, 87
TrackIT	80

General Lab Products

Transfer Racks	111
Transfer Racks for Eppendorf SmartBlock™	111
TransferMan® 4r	291
Tube Strips	262 - 264
Tubes 3810X	121
Tubes 5.0 mL	124
Tubes Accessories	140
Tubes Safe-Lock	122
Twin.tec PCR plates	258
twin.tec real-time PCR plates	261, 262
ULT Freezer Performance Plans	392
Universal Adapters for Rotor S-4xUniversal	203
Universal Platforms and Clamps for Incubated Shakers	352
Universal Platforms and Clamps for Innova® Open Air Shakers	354
UVette®	242
Varipette® 4720	80
Varispenser® 2/Varispenser® 2x	84
Vis Cuvettes	243
ViscoTip®	76
VisioNize®	273
VisioNize® box	277, 337
Volume range Pipette Tips	58 - 62
Workstations for Microinjection and Micromanipulation	308
Xplorer	36, 37
Xplorer plus	38, 39
Xplorer plus Move It™	41
Xplorer/Xplorer plus	35
µCuvette G1.0	241

EU-IVD Products

5.0 mL Tubes	418
Centrifuge 5418 R	420
Centrifuge 5420	421
Centrifuge 5424 R	422
Centrifuge 5425	423
Centrifuge 5427 R	424
Centrifuge 5430/5430 R	425
Centrifuge 5702/5702 R/5702 RH	426
Centrifuge 5804/5804 R and 5810/5810 R	427
Centrifuge 5910 R	429
Centrifuge 5920 R	430
Centrifuge Packages	428
Centrifuge Packages 5910 R	429
Centrifuge Packages 5920 R	430
ep Dualfilter T.I.P.S.® SealMax	416
Eppendorf Reference® 2	403, 404
Eppendorf Research® plus	406, 408
Eppendorf Safe-Lock Tubes	418
Eppendorf Tubes® 5.0 mL	418
epT.I.P.S.®	410, 412, 414
epT.I.P.S.® 384	417
epT.I.P.S.® Box/epT.I.P.S.® Set	411
epT.I.P.S.® Racks	411
epT.I.P.S.® Reloads	411
epT.I.P.S.® Singles	411
epT.I.P.S.® Standard	410
Manual Pipettes	403, 406
Microcentrifuges	419
MiniSpin®/MiniSpin® plus	419
Overview about Packaging Units	411
Pipette tips	410, 412, 414, 417
Safe-Lock Tubes	418
Tips	410, 417
Tubes 5.0 mL	418
Tubes Safe-Lock	418

EU-Medical Devices

CellTram® 4m Air/Oil	433, 434
TransferMan® 4m	431, 432

Order no.	Page	Order no.	Page	Order no.	Page	Order no.	Page
0013 021 566	243	0030 058 607	31, 34, 40	0030 073 452	59	0030 076 176	59
0013 022 153	31, 34, 40	0030 071 638	61	0030 073 460	413	0030 076 184	59
0030 000 650	61	0030 071 646	61	0030 073 479	59	0030 076 192	61
0030 000 730	61	0030 071 654	61	0030 073 487	413	0030 076 206	61
0030 000 765	61	0030 071 662	61	0030 073 495	59	0030 076 214	61
0030 000 781	61	0030 072 006	59	0030 073 509	414	0030 076 273	64
0030 000 811	59	0030 072 014	59	0030 073 517	61	0030 076 281	64
0030 000 838	59	0030 072 022	59	0030 073 606	414	0030 076 290	59
0030 000 854	59	0030 072 030	59	0030 073 614	414	0030 076 303	59
0030 000 870	59	0030 072 049	59	0030 073 622	414	0030 076 311	59
0030 000 889	59	0030 072 057	59	0030 073 630	61	0030 076 320	59
0030 000 897	59	0030 072 065	59	0030 073 649	61	0030 076 338	59
0030 000 900	59	0030 072 073	59	0030 073 657	61	0030 076 346	59
0030 000 919	59	0030 072 251	59	0030 073 746	413	0030 076 354	59
0030 000 927	59	0030 072 260	59	0030 073 754	59	0030 076 362	61
0030 000 935	59	0030 072 278	59	0030 073 762	413	0030 076 370	417
0030 000 951	61	0030 072 286	59	0030 073 770	59	0030 076 389	417
0030 000 978	61	0030 072 367	59	0030 073 789	413	0030 076 397	413
0030 001 222	63	0030 072 375	59	0030 073 797	59	0030 076 400	413
0030 001 320	63	0030 072 383	59	0030 073 800	413	0030 076 419	413
0030 010 019	413	0030 072 391	59	0030 073 819	59	0030 076 427	413
0030 010 027	59	0030 073 002	413	0030 073 827	413	0030 076 435	413
0030 010 035	413	0030 073 010	59	0030 073 835	59	0030 076 443	413
0030 010 043	59	0030 073 029	413	0030 073 843	413	0030 076 451	413
0030 010 051	413	0030 073 037	59	0030 073 851	59	0030 076 460	414
0030 010 060	59	0030 073 045	413	0030 073 860	413	0030 076 478	414
0030 014 383	97	0030 073 053	59	0030 073 878	59	0030 076 486	414
0030 014 391	97	0030 073 061	413	0030 073 886	414	0030 076 494	413
0030 014 405	97	0030 073 070	59	0030 073 894	61	0030 076 508	413
0030 014 413	97	0030 073 088	413	0030 075 226	59	0030 076 516	413
0030 014 421	96	0030 073 096	59	0030 075 234	59	0030 076 524	413
0030 014 430	96	0030 073 100	413	0030 075 242	59	0030 076 532	413
0030 014 448	97	0030 073 118	59	0030 075 250	59	0030 076 540	413
0030 014 456	97	0030 073 126	413	0030 075 269	59	0030 076 559	413
0030 014 464	96	0030 073 134	59	0030 075 277	61	0030 076 567	414
0030 014 472	96	0030 073 142	414	0030 075 285	61	0030 077 598	63
0030 014 480	97	0030 073 150	61	0030 075 293	61	0030 078 500	62
0030 014 499	97	0030 073 169	414	0030 075 307	61	0030 078 519	62
0030 014 502	96	0030 073 177	61	0030 075 315	61	0030 078 527	62
0030 014 510	96	0030 073 207	413	0030 075 323	413	0030 078 535	62
0030 014 529	96	0030 073 215	59	0030 075 331	413	0030 078 543	62
0030 014 537	96	0030 073 223	413	0030 075 340	413	0030 078 551	62
0030 014 545	96	0030 073 231	59	0030 075 358	413	0030 078 560	62
0030 014 553	96	0030 073 240	413	0030 075 366	413	0030 078 578	62
0030 014 561	96	0030 073 258	59	0030 075 374	414	0030 078 586	62
0030 014 600	97	0030 073 266	413	0030 075 382	414	0030 078 594	62
0030 014 618	97	0030 073 274	59	0030 075 390	414	0030 078 616	63
0030 014 626	97	0030 073 282	413	0030 075 404	414	0030 078 624	63
0030 014 634	97	0030 073 290	59	0030 075 412	414	0030 078 632	62
0030 014 642	97	0030 073 304	413	0030 076 001	64	0030 078 640	62
0030 014 650	97	0030 073 312	59	0030 076 010	64	0030 078 659	62
0030 015 185	97	0030 073 320	413	0030 076 028	64	0030 078 667	62
0030 015 193	97	0030 073 339	59	0030 076 036	64	0030 078 675	62
0030 015 207	97	0030 073 347	414	0030 076 044	64	0030 078 683	62
0030 015 215	97	0030 073 355	61	0030 076 052	64	0030 078 691	62
0030 015 223	97	0030 073 363	413	0030 076 060	417	0030 078 705	62
0030 015 231	97	0030 073 371	59	0030 076 079	417	0030 078 713	62
0030 015 240	97	0030 073 380	413	0030 076 087	417	0030 078 721	62
0030 015 258	97	0030 073 398	59	0030 076 095	417	0030 078 730	62
0030 048 130	80	0030 073 401	413	0030 076 125	59	0030 078 748	62
0030 050 525	80	0030 073 410	59	0030 076 133	59	0030 078 756	416
0030 050 533	80	0030 073 428	413	0030 076 141	59	0030 078 764	416
0030 050 541	80	0030 073 436	59	0030 076 150	59	0030 078 772	416
0030 050 568	80	0030 073 444	413	0030 076 168	59	0030 078 780	416

Order no.	Page	Order no.	Page	Order no.	Page	Order no.	Page
0030 078 799	416	0030 108 132	137	0030 122 321	125	0030 128 605	260
0030 078 802	416	0030 108 302	125, 137	0030 122 330	125	0030 128 613	260
0030 078 810	62	0030 108 310	125, 139	0030 122 348	139	0030 128 648	260
0030 078 829	62	0030 118 405	127	0030 122 356	137	0030 128 656	260
0030 078 837	62	0030 118 413	127	0030 122 364	125	0030 128 664	260
0030 078 845	62	0030 118 421	127	0030 122 402	125	0030 128 672	260
0030 078 853	65	0030 119 380	125	0030 122 410	127	0030 128 680	260
0030 078 861	65	0030 119 401	125	0030 122 429	127	0030 129 300	260
0030 079 345	243	0030 119 452	125	0030 122 437	127	0030 129 318	260
0030 079 353	243	0030 119 460	125	0030 123 301	123	0030 129 326	260
0030 079 400	282	0030 119 479	125	0030 123 328	123	0030 129 334	260
0030 079 418	282	0030 119 487	125	0030 123 344	123	0030 129 342	260
0030 079 426	282	0030 119 509	125	0030 123 603	123	0030 129 350	260
0030 079 434	282	0030 119 517	418	0030 123 611	123	0030 129 504	260
0030 079 442	282	0030 119 606	125	0030 123 620	123	0030 129 512	260
0030 079 450	282	0030 119 800	140	0030 124 235	229	0030 129 547	260
0030 079 469	282	0030 119 819	121, 123, 140	0030 124 243	229	0030 129 580	260
0030 079 477	282	0030 119 827	125, 129, 140	0030 124 332	262	0030 129 598	260
0030 079 485	282	0030 119 835	129, 140	0030 124 359	262	0030 129 601	260
0030 079 493	282	0030 119 843	140	0030 124 537	263	0030 129 610	260
0030 089 405	79	0030 119 851	140, 242, 243, 290	0030 124 545	265	0030 129 628	260
0030 089 413	79			0030 124 707	262	0030 129 636	261
0030 089 421	79	0030 120 086	123	0030 124 804	262	0030 129 644	261
0030 089 430	79	0030 120 094	123	0030 124 812	262	0030 129 660	260
0030 089 448	79	0030 120 159	123	0030 124 820	262	0030 129 679	260
0030 089 456	79	0030 120 167	123	0030 124 839	263	0030 131 517	140
0030 089 464	79	0030 120 175	123	0030 124 847	263	0030 131 525	140
0030 089 472	79	0030 120 183	123	0030 124 901	261	0030 132 505	261
0030 089 480	79	0030 120 191	123	0030 124 910	261	0030 132 513	261
0030 089 502	79	0030 120 205	123	0030 124 928	261	0030 132 530	261
0030 089 618	79	0030 120 213	123	0030 125 150	121	0030 132 548	261
0030 089 626	79	0030 120 221	123	0030 125 177	121	0030 132 700	261
0030 089 634	79	0030 120 230	123	0030 125 185	121	0030 132 718	261
0030 089 642	79	0030 120 248	123	0030 125 193	121	0030 132 874	264
0030 089 650	79	0030 120 973	141	0030 125 207	121	0030 132 882	264
0030 089 669	79	0030 121 023	123	0030 125 215	121	0030 132 890	264
0030 089 677	79	0030 121 112	123	0030 126 505	100	0030 132 947	265
0030 089 685	79	0030 121 120	123	0030 126 513	100	0030 133 307	260
0030 089 693	79	0030 121 139	123	0030 126 521	100	0030 133 331	260
0030 089 715	79	0030 121 147	123	0030 126 530	101	0030 133 358	260
0030 089 723	79	0030 121 155	123	0030 126 548	101	0030 133 366	260
0030 089 731	79	0030 121 503	418	0030 126 556	88, 100	0030 133 374	260
0030 089 740	79	0030 121 570	123	0030 127 692	83	0030 133 382	260
0030 089 758	79	0030 121 589	123	0030 127 706	83	0030 133 390	260
0030 089 766	79	0030 121 597	123	0030 127 714	83	0030 133 404	260
0030 089 774	79	0030 121 686	123	0030 127 722	83	0030 140 508	141, 289
0030 089 782	79	0030 121 694	123	0030 127 730	83	0030 140 516	141, 289
0030 089 790	79	0030 121 708	123	0030 127 749	83	0030 140 524	121, 123, 141, 289
0030 089 804	79	0030 121 872	418	0030 127 781	265		
0030 089 812	79	0030 121 880	418	0030 127 790	265	0030 140 532	125, 141, 289
0030 089 820	79	0030 122 151	129	0030 127 838	140, 257, 264	0030 140 540	141, 289
0030 089 839	79	0030 122 160	129	0030 127 854	140, 257, 264	0030 140 567	141, 289
0030 089 847	79	0030 122 178	129	0030 127 870	140	0030 140 583	129, 141, 289
0030 089 855	79	0030 122 186	129	0030 127 889	140	0030 140 591	129, 141, 289
0030 089 863	79	0030 122 194	129	0030 127 960	140	0030 140 613	125, 141, 289
0030 089 871	79	0030 122 208	129, 139	0030 127 978	140	0030 140 729	141, 289
0030 089 936	79	0030 122 216	129, 137	0030 128 508	260	0030 501 101	135
0030 106 300	242	0030 122 224	129	0030 128 516	260	0030 501 110	135
0030 106 318	242	0030 122 232	129, 139	0030 128 524	260	0030 501 136	135
0030 108 035	139	0030 122 240	129, 137	0030 128 532	260	0030 501 144	135
0030 108 051	139	0030 122 259	129	0030 128 540	260	0030 501 209	135
0030 108 078	139	0030 122 267	129	0030 128 575	260	0030 501 217	135
0030 108 094	137	0030 122 305	125	0030 128 583	260	0030 501 233	135
0030 108 116	137	0030 122 313	125	0030 128 591	260	0030 501 241	135

Order no.	Page	Order no.	Page	Order no.	Page	Order no.	Page
0030 501 306	135	0030 627 300	138	0050 600 122	377	0082 030 027	381
0030 501 314	135	0030 628 306	136	0050 600 128	377	0082 030 028	381
0030 501 330	135	0030 700 015	316	0050 600 130	377	0082 030 029	380
0030 501 349	135	0030 700 112	316	0050 600 255	380	0082 030 033	381
0030 502 108	135	0030 701 011	316	0050 600 259	380	0082 030 034	381
0030 502 116	135	0030 701 119	316	0082 000 000	377	0082 030 035	381
0030 502 132	135	0030 702 018	316	0082 000 001	377	0082 030 037	381
0030 502 140	135	0030 702 115	316	0082 000 002	377	0082 030 038	381
0030 502 205	135	0030 710 010	316	0082 000 003	377	0082 030 039	380
0030 502 213	135	0030 710 029	316	0082 000 104	377	0082 030 169	383
0030 502 230	135	0030 710 118	316	0082 000 105	377	0082 040 027	390
0030 502 248	135	0030 710 126	316	0082 000 106	377	0082 040 043	391
0030 502 302	135	0030 711 017	316	0082 000 107	377	0082 040 044	391
0030 502 310	135	0030 711 025	316	0082 000 114	377	0082 040 045	391
0030 502 337	135	0030 711 114	316	0082 000 115	377	0082 040 047	391
0030 502 345	135	0030 711 122	316	0082 000 116	377	0082 040 048	391
0030 503 104	138	0030 712 013	316	0082 000 117	377	0082 040 049	391
0030 503 147	138	0030 712 021	316	0082 010 003	395	0082 050 003	401
0030 503 201	138	0030 712 110	316	0082 010 004	395	0082 050 004	401
0030 503 244	138	0030 712 129	316	0082 010 005	395	0082 050 005	401
0030 504 100	136	0030 720 016	316	0082 010 007	395	0082 050 007	401
0030 504 119	136	0030 720 113	316	0082 010 008	395	0082 050 008	401
0030 504 208	136	0030 720 130	316	0082 010 009	395	0082 050 009	401
0030 504 216	136	0030 721 012	316	0082 010 013	395	0082 060 003	397
0030 504 305	136	0030 721 110	316	0082 010 014	395	0082 060 004	397
0030 505 107	135	0030 722 019	316	0082 010 015	395	0082 060 005	397
0030 505 204	135	0030 722 116	316	0082 010 017	395	0082 060 007	397
0030 505 301	135	0030 723 015	316	0082 010 018	395	0082 060 008	397
0030 506 103	135	0030 723 112	316	0082 010 019	395	0082 060 009	397
0030 506 200	135	0030 730 011	316	0082 020 003	387	0082 070 003	393
0030 506 308	135	0030 730 020	133	0082 020 004	387	0082 070 004	393
0030 507 100	138	0030 730 119	316	0082 020 005	387	0082 070 005	393
0030 507 207	138	0030 730 135	316	0082 020 008	387	0082 070 007	393
0030 508 106	136	0030 740 009	321	0082 020 009	387	0082 070 008	393
0030 508 203	136	0030 740 017	321	0082 020 013	387	0082 070 009	393
0030 521 102	135	0030 741 005	321	0082 020 014	387	0082 080 003	399
0030 522 109	135	0030 741 013	133, 321	0082 020 015	387	0082 080 004	399
0030 523 105	138	0030 741 021	321	0082 020 018	387	0082 080 005	399
0030 524 101	136	0030 741 030	321	0082 020 019	387	0082 080 007	399
0030 525 108	135	0030 741 048	133	0082 020 023	387	0082 080 008	399
0030 526 104	135	0030 742 001	321	0082 020 024	387	0082 080 009	399
0030 527 100	138	0030 742 010	321	0082 020 025	387	0082 080 013	399
0030 528 107	136	0030 742 028	321	0082 020 028	387	0082 080 014	399
0030 601 106	131	0030 742 036	321	0082 020 029	387	0082 080 015	399
0030 601 203	131	0030 742 044	321	0082 020 033	387	0082 080 017	399
0030 601 300	131	0030 742 052	321	0082 020 034	387	0082 080 018	399
0030 601 475	133	0030 742 060	321	0082 020 035	387	0082 080 019	399
0030 601 572	133	0030 742 079	321	0082 020 038	387	0082 080 023	399
0030 601 670	133	0038 110 010	318	0082 020 039	387	0082 080 024	

Order no.	Page	Order no.	Page	Order no.	Page	Order no.	Page
0082 080 219	399	3122 000 027	408	3125 000 222	30	4861 000 792	40
0082 100 003	385	3122 000 035	408	3880 000 011	119	4861 000 793	40
0082 100 004	385	3122 000 043	408	3880 000 151	111, 114	4861 000 794	43
0082 100 005	385	3122 000 051	408	3880 000 160	119	4861 000 795	43
0082 100 007	385	3122 000 060	408	3880 000 178	119	4861 000 805	39
0082 100 008	385	3122 000 078	409	3880 000 305	111, 114	4861 000 813	39
0082 100 009	385	3122 000 086	409	3880 001 018	119	4861 000 816	43
0082 110 003	389	3122 000 094	409	3880 001 026	119	4861 000 817	43
0082 110 004	389	3122 000 108	409	3880 001 042	119	4861 000 818	43
0082 110 005	389	3122 000 213	408	3880 001 166	119	4861 000 821	39
0082 110 007	389	3122 000 221	408	3880 001 174	119	4861 000 830	39
0082 110 009	389	3122 610 003	31, 34, 40	3881 000 015	119	4861 000 833	43
0082 110 013	389	3122 611 000	31	3881 000 023	119	4861 000 834	43
0082 110 014	389	3122 612 006	31, 40	3881 000 031	119	4861 000 835	43
0082 110 015	389	3122 613 002	31, 40	3903 000 014	31, 34, 40, 80	4861 605 006	40
0082 110 017	389	3123 000 012	28	4099 001 009	242	4880 603 006	40
0082 110 019	389	3123 000 020	28	4099 002 005	242	4920 000 016	404
1006 000 009	277, 337	3123 000 039	28	4099 003 001	242	4920 000 024	404
1006 073 006	277, 337	3123 000 047	28	4099 005 004	242	4920 000 032	404
3116 000 015	45	3123 000 055	28	4099 100 007	242	4920 000 040	404
3116 000 023	45	3123 000 063	28	4309 000 019	290	4920 000 059	404
3116 000 031	45	3123 000 071	29	4421 601 009	81	4920 000 067	404
3116 000 040	45	3123 000 080	29	4423 000 010	82	4920 000 075	404
3116 000 058	45	3123 000 098	28	4423 601 014	82	4920 000 083	404
3116 000 112	45	3123 000 101	28	4430 000 018	81	4920 000 091	404
3116 000 120	45	3123 000 144	29	4430 605 009	81	4920 000 105	404
3116 000 139	45, 75	3123 000 900	31	4430 606 005	81	4920 000 113	404
3116 000 147	45, 72	3123 000 918	31	4720 000 011	80	4920 000 903	404
3116 602 007	45	3123 000 926	31	4861 000 015	36	4920 000 911	404
3116 603 003	45	3124 000 016	28	4861 000 017	36	4920 000 920	404
3120 000 011	407	3124 000 024	28	4861 000 023	36	4920 622 009	34
3120 000 020	407	3124 000 032	28	4861 000 027	36	4920 623 005	31, 34
3120 000 038	407	3124 000 040	28	4861 000 031	36	4920 624 001	31, 34
3120 000 046	407	3124 000 059	28	4861 000 040	36	4920 625 008	34
3120 000 054	407	3124 000 067	28	4861 000 044	36	4920 626 004	34
3120 000 062	407	3124 000 075	28	4861 000 058	36	4921 000 010	403
3120 000 070	407	3124 000 083	28	4861 000 066	36	4921 000 028	403
3120 000 089	407	3124 000 091	28	4861 000 104	37	4921 000 036	403
3120 000 097	407	3124 000 105	28	4861 000 112	37	4921 000 044	403
3120 000 100	407	3124 000 113	28	4861 000 120	37	4921 000 052	403
3120 000 143	407	3124 000 121	28	4861 000 139	37	4921 000 060	403
3120 000 909	407	3125 000 010	29	4861 000 147	37	4921 000 079	403
3120 000 917	407	3125 000 028	30	4861 000 155	37	4921 000 087	403
3120 000 925	407	3125 000 036	29	4861 000 163	37	4921 000 095	403
3120 633 006	31, 34	3125 000 044	30	4861 000 171	37	4921 000 109	403
3120 634 002	31, 34, 40	3125 000 052	29	4861 000 708	38	4921 000 117	403
3120 635 009	31, 34, 40	3125 000 060	30	4861 000 710	38	4921 000 125	403
3120 636 005	31	3125 000 079	30	4861 000 716	38	4921 000 133	403
3120 639 004	31	3125 000 087	30	4861 000 720	38	4921 000 141	403
3121 000 015	406	3125 000 095	30	4861 000 724	38	4921 000 150	403
3121 000 023	406	3125 000 109	30	4861 000 732	38	4921 000 168	403
3121 000 031	406	3125 000 117	43	4861 000 736	38	4921 000 176	403
3121 000 040	406	3125 000 125	43	4861 000 740	38	4922 000 013	405
3121 000 058	406	3125 000 133	43	4861 000 759	38	4922 000 021	405
3121 000 066	406	3125 000 141	43	4861 000 767	39	4922 000 030	405
3121 000 074	406	3125 000 150	43	4861 000 775	39	4922 000 048	405
3121 000 082	406	3125 000 168	43	4861 000 778	40	4922 000 056	405
3121 000 090	406	3125 000 176	43	4861 000 779	40	4922 000 064	405
3121 000 104	406	3125 000 184	43	4861 000 781	43	4924 000 010	33
3121 000 112	406	3125 000 192	43	4861 000 782	43	4924 000 029	33
3121 000 120	406	3125 000 206	43	4861 000 783	39	4924 000 037	33
3122 000 019	408	3125 000 214	29	4861 000 791	39	4924 000 045	33

Order no.	Page	Order no.	Page	Order no.	Page	Order no.	Page
4924 000 053	33	4966 507 000	87	5075 005 212	381	5075 789 000	101
4924 000 061	33	4966 508 006	87	5075 005 220	381	5075 790 009	102
4924 000 070	33	4966 509 002	87	5075 005 239	381	5075 791 005	102
4924 000 088	33	4966 511 007	87	5075 005 247	381	5075 792 001	102
4924 000 096	33	4966 614 000	87	5075 005 263	381, 383	5075 792 028	102
4924 000 100	33	4966 615 007	87	5075 014 009	99	5075 792 044	102
4924 000 118	33	4967 000 014	85	5075 014 220	99	5075 792 060	102
4924 000 908	34	4967 000 022	85	5075 014 300	99	5075 792 087	102
4924 000 916	34	4967 000 030	85	5075 015 200	99	5075 792 109	102
4924 000 924	34	4967 000 049	85	5075 751 003	103	5075 792 125	102
4925 000 014	33	4967 000 057	85	5075 751 054	101	5075 793 008	102
4925 000 022	33	4967 000 065	85	5075 751 160	101	5075 794 004	102
4925 000 030	33	4980 215 003	72	5075 751 186	101	5075 795 000	102
4925 000 049	33	4982 000 012	72	5075 751 275	102	5075 796 007	102
4925 000 057	33	4982 000 314	72	5075 751 305	101	5075 798 000	98
4925 000 065	33	4986 603 005	40, 75	5075 751 330	101	5075 799 049	100
4925 000 073	33	4987 000 010	75	5075 751 364	100	5075 799 081	100
4925 000 081	33	4987 000 029	75	5075 751 399	96, 100	5075 799 103	100
4925 000 090	33	4987 000 371	75	5075 751 453	102	5075 799 120	100
4925 000 103	33	4987 000 380	75	5075 751 500	103	5075 799 146	100
4925 000 111	33	5069 000 012	88	5075 751 526	101	5075 799 162	100
4925 000 120	33	5069 000 110	88	5075 751 577	101	5075 799 189	100
4925 000 138	33	5069 000 217	88	5075 751 640	101	5075 799 260	100
4925 000 146	33	5069 000 314	88	5075 751 666	101	5075 799 340	100, 125
4925 000 154	33	5069 072 005	101	5075 751 720	103	5075 799 421	100
4925 000 162	33	5069 073 001	101	5075 751 747	102	5181 070 015	293
4925 000 170	33	5069 074 008	88, 101	5075 751 763	103	5181 150 094	293
4926 000 018	34	5070 000 282	95	5075 751 780	103	5181 301 009	295
4926 000 026	34	5070 000 283	95	5075 751 836	101	5181 303 001	295
4926 000 034	34	5070 005 036	380	5075 751 879	100	5181 305 004	295
4926 000 042	34	5070 005 044	380	5075 751 895	100	5181 307 007	295
4926 000 050	34	5070 006 032	95	5075 751 917	100	5181 309 000	295
4926 000 069	34	5070 006 108	95	5075 751 933	100	5192 000 019	292
4960 800 040	87	5070 752 001	98	5075 751 950	100	5192 071 005	293
4960 800 058	87	5073 000 582	95	5075 752 000	103	5192 072 001	293
4960 800 082	87	5073 000 590	103	5075 753 006	103	5192 073 008	293
4960 800 090	87	5073 000 604	95	5075 753 103	103	5192 080 004	293, 302
4960 800 104	87	5073 000 612	95	5075 754 002	100	5192 081 000	293, 302
4960 800 120	87	5073 000 930	95	5075 755 009	103	5192 082 007	293
4960 800 139	87	5073 000 949	95	5075 757 001	98	5192 301 000	294
4960 800 147	87	5073 000 957	95	5075 760 002	102	5192 302 007	294
4960 800 155	87	5073 000 965	95	5075 761 009	102	5192 306 002	294
4960 805 009	87	5073 751 006	102	5075 762 005	102	5192 307 009	294
4960 832 006	87	5073 920 061	380	5075 763 001	102	5192 308 005	294
4960 834 009	87	5073 920 070	380	5075 766 000	101	5192 311 006	294
4960 835 005	87	5075 000 301	95	5075 767 007	101	5192 312 002	294
4960 839 000	87	5075 000 302	95	5075 767 031	101	5192 316 008	294
4960 851 000	87	5075 000 303	95	5075 769 000	101	5192 317 004	294
4965 000 017	86	5075 000 304	95	5075 771 004	101	5192 318 000	294
4965 000 025	86	5075 000 305	95	5075 772 000	100	5192 321 001	294
4966 000 010	85	5075 000 610	98	5075 774 003	99	5192 325 007	294
4966 000 029	85	5075 000 628	101	5075 775 000	102	5193 000 012	291
4966 000 037	85	5075 000 636	102	5075 776 006	102	5194 000 016	297</

Order no.	Page	Order no.	Page	Order no.	Page	Order no.	Page
5195 000 060	307	5366 000 021	111, 114	5425 715 005	146, 147, 148, 150, 152, 155, 159, 226, 229, 419, 420	5490 034 007	230
5195 000 079	307	5367 000 025	111, 114			5490 035 003	230
5195 000 087	297, 307	5382 000 015	111			5490 036 000	230
5195 000 095	297, 307	5383 000 019	112	5425 716 001	146, 147, 148, 150, 152, 155, 159, 226, 229, 419, 420	5490 037 006	230
5196 000 013	299	5384 000 012	116			5490 038 002	230
5196 000 030	299	5385 000 016	116			5490 039 009	230
5196 061 004	299	5386 000 010	116			5490 040 007	230
5196 062 000	299, 302	5387 000 013	116	5425 717 008	146, 147, 148, 150, 152, 155, 159, 226, 229, 419, 420	5490 041 003	230
5196 063 007	302	5391 000 001	257			5490 042 000	230
5196 081 005	299, 302	5391 070 018	257			5490 043 006	230
5196 082 001	297, 299, 302	5391 070 026	257	5425 723 008	229	5490 044 002	230
5196 083 008	297, 299, 302	5391 070 034	257	5427 000 011	425	5490 045 009	230
5196 084 004	297, 299, 302	5392 000 005	257	5427 000 015	156	5490 047 001	230
5196 085 000	297, 299, 302	5392 070 011	257	5427 000 210	156	5495 400 001	148
5196 086 007	299, 302	5392 070 020	257	5427 000 216	425	5495 404 007	148
5196 088 000	299	5392 070 038	257	5427 000 410	425	5495 500 006	152
5196 089 006	299	5401 000 010	147	5427 000 415	156	5495 503 005	152
5242 952 008	307	5401 000 013	420	5427 000 610	156	5495 505 008	152
5242 956 003	63, 307	5404 000 010	149	5427 000 615	425	5495 508 007	152
5242 957 000	307	5404 000 014	422	5427 700 005	159	5495 510 001	152
5252 000 013	302	5404 000 210	149	5427 705 007	159	5495 512 004	152
5252 070 011	302	5404 000 219	422	5427 708 006	159, 167	5702 000 010	163
5252 070 020	293	5404 000 410	149	5427 710 000	159	5702 000 019	426
5252 070 054	302	5404 000 413	422	5427 712 003	159	5702 000 320	163, 173
5253 000 017	302	5404 000 610	149	5427 714 006	159	5702 000 329	426, 428
5280 000 010	99	5404 000 618	422	5427 716 009	159	5702 700 002	167
5280 000 037	99	5405 000 018	423	5427 723 005	159	5702 704 008	167
5280 000 053	99	5405 000 115	151	5427 726 004	159	5702 705 004	167
5280 000 100	99	5405 000 212	423	5427 727 000	159	5702 709 000	166
5280 000 215	99	5405 000 310	151	5427 732 004	159	5702 710 008	166
5280 000 231	99	5405 000 417	423	5427 734 007	159	5702 711 004	166
5280 000 258	99	5405 000 514	151	5427 735 003	159	5702 712 000	166
5280 000 304	99	5405 000 611	423	5427 736 000	159	5702 713 007	166
5282 000 018	101	5405 000 719	151	5427 737 006	159	5702 716 006	166
5301 316 005	229	5409 000 010	153	5427 738 002	159	5702 718 009	165
5305 000 100	229	5409 000 012	424	5427 740 007	159	5702 719 005	165
5305 000 304	229	5409 000 210	153	5427 741 003	159	5702 720 003	165
5305 000 509	229	5409 000 217	424	5427 742 000	159	5702 721 000	165
5305 000 703	229	5409 000 530	153	5427 743 006	159	5702 722 006	165
5306 000 006	111, 114	5409 000 535	424	5427 746 005	125, 159	5702 723 002	165
5307 000 000	111, 114	5409 000 630	153	5427 747 001	125, 159	5702 724 009	165
5308 000 003	111, 112, 115, 116	5409 000 632	424	5427 750 002	125, 159	5702 732 001	165
		5409 700 006	125, 155	5427 752 005	159	5702 733 008	125, 165
5309 000 007	111, 114, 125	5409 702 009	155	5427 753 001	159	5702 734 004	165
5309 000 333	125	5409 704 001	155	5427 753 001	159	5702 735 000	165
5310 000 002	111, 114	5409 706 004	155	5427 754 008	159	5702 736 007	165
5316 000 004	111, 114	5409 708 007	155	5427 755 004	159	5702 737 003	165
5322 000 008	111, 112, 116	5409 710 001	155	5427 757 007	159	5702 737 003	165
5341 611 000	252	5409 710 001	155	5428 000 010	156	5702 740 004	166
5341 612 006	252	5409 712 004	155	5428 000 010	156	5702 745 006	165
5353 000 510	117	5409 714 007	155	5428 000 015	425	5702 746 002	167
5353 040 113	117	5409 715 003	155	5428 000 205	156	5702 747 009	167
5353 040 121	117	5418 707 005	147	5428 000 210	425	5702 752 002	159, 167
5353 040 130	117	5420 000 016	421	5428 000 410	156	5702 753 000	165
5353 040 148	117	5420 000 113	148	5428 000 414	425	5702 755 004	165
5353 040 156	117	5420 000 210	421	5428 000 610	156	5702 757 007	159
5360 000 038	111, 114	5420 000 210	421	5428 000 619	425	5702 757 007	159
5361 000 031	111, 114	5420 000 318	148	5452 000 010	146	5702 763 004	166
5362 000 035	111, 114	5424 700 004	150	5452 000 018	419	5703 000 010	163
5363 000 039	111, 114	5424 702 007	150	5452 720 008	146, 419	5703 000 012	426
5363 000 233	111, 114	5424 704 000	150	5452 727 007	146, 419	5703 000 320	163
5364 000 024	111, 114	5424 706 002	150	5453 000 011	419	5703 000 322	426
5365 000 028	111, 114	5424 860 036	387	5453 000 015	146	5703 000 420	426, 428
5365 000 109	111, 114	5424 860 044	387	5490 030 001	230	5703 000 425	163, 173
		5424 860 109	387	5490 032 004	230	5704 000 010	163
		5424 860 150	387			5704 000 016	426
						5804 000 010	170
						5804 000 013	427
						5804 000 320	173

Order no.	Page	Order no.	Page	Order no.	Page	Order no.	Page
5804 000 323	428	5810 000 525	173	5820 727 004	192, 224	5895 150 004	224
5804 000 520	173	5810 000 620	173	5820 728 000	192, 224	5895 155 006	227
5804 000 528	428	5810 000 629	428	5820 729 007	192, 224	5895 160 000	227
5804 706 005	188, 189	5810 702 003	184, 185	5820 730 005	125, 192, 224	5895 170 005	204
5804 709 004	189	5810 709 008	185	5820 732 008	125	5895 171 001	204
5804 712 005	189	5810 710 006	185	5820 733 004	192, 224	5895 175 007	222
5804 715 004	177	5810 711 002	185	5820 734 000	192, 224	5895 180 000	206
5804 717 007	188	5810 716 004	185	5820 740 000	181	5895 190 006	213
5804 718 003	188	5810 718 007	183	5820 741 007	181	5895 200 001	202
5804 719 000	189	5810 720 001	183, 204	5820 742 003	181	5910 700 008	206
5804 726 006	177	5810 721 008	183, 204	5820 743 000	181	5910 701 004	206
5804 727 002	191	5810 722 004	183, 204	5820 744 006	181	5910 702 000	206
5804 730 003	178	5810 723 000	183, 204	5820 747 005	181, 209, 219	5910 703 007	206
5804 731 000	178	5810 724 007	183, 204	5820 748 001	181, 209	5910 704 003	206
5804 732 006	178	5810 725 003	183	5820 754 001	181	5910 705 000	206
5804 735 005	178	5810 728 002	183, 204	5820 755 008	181	5910 706 006	206
5804 737 008	189	5810 729 009	183, 200	5820 760 001	177	5910 707 002	200
5804 738 004	190	5810 730 007	183	5820 765 003	125, 177	5910 708 009	206
5804 739 000	190	5810 739 004	183, 204	5820 768 002	152, 155, 159, 177, 226	5910 709 005	206
5804 740 009	179	5810 741 009	183, 204	5820 769 009	152, 155, 159, 177, 226	5910 711 000	206
5804 741 005	189	5810 742 005	183, 204	5820 770 007	152, 155, 159, 177, 226	5910 712 006	206
5804 746 007	187	5810 743 001	183			5910 714 009	206
5804 750 004	188	5810 745 004	183, 204			5910 750 005	202
5804 751 000	188	5810 746 000	183, 204	5820 771 003	178	5910 751 001	203
5804 752 007	188	5810 747 007	183, 204	5820 772 000	178	5910 752 008	203
5804 753 003	188	5810 748 003	183, 204	5820 772 000	178	5910 753 004	203
5804 754 000	188	5810 750 008	184	5821 020 010	171	5910 754 000	203
5804 755 006	188	5810 751 004	184	5825 706 005	179, 229	5910 755 007	203
5804 756 002	188	5810 752 000	184	5825 708 008	179	5910 756 003	203
5804 757 009	188	5810 753 007	184	5825 709 004	179	5910 757 000	203
5804 758 005	188	5810 754 003	184	5825 711 009	179	5910 758 006	203
5804 759 001	188	5810 755 000	184	5825 713 001	179	5910 760 000	203
5804 760 000	188	5810 756 006	184	5825 719 000	179	5910 762 003	203
5804 761 006	188	5810 757 002	184	5825 722 000	183, 204	5910 764 006	203
5804 770 005	190	5810 758 009	184	5825 730 003	183	5910 769 008	203
5804 771 001	190	5810 759 005	184	5825 732 006	181, 209, 219	5910 770 006	200
5804 772 008	190	5810 760 003	184	5825 733 002	181, 209, 219	5920 700 006	219
5804 773 004	190	5810 761 000	184	5825 734 009	181, 209, 219	5920 701 002	219
5804 774 000	190	5810 763 002	184	5825 736 001	181, 209, 219	5920 703 005	219
5804 775 007	190	5810 770 009	184	5825 738 004	181, 209, 219	5920 705 008	217, 219
5804 776 003	190	5810 770 009	184	5825 739 000	125	5920 706 004	217
5804 777 000	125, 190	5810 860 040	387	5825 740 009	181, 209, 219	5920 707 000	217

Order no.	Page	Order no.	Page	Order no.	Page	Order no.	Page	Order no.	Page	Order no.	Page	Order no.	Page	Order no.	Page
5920 744 003	212	6001 012 510	285	6135 005 019	389	6731 000 351	329	F652999006	279	M1191-9910	341, 344, 347, 353, 355	M1282-5011	340	M1335-0800	342
5920 745 000	212	6001 012 910	285	6135 005 027	389	6731 000 511	329	F660300001	278	M1191-9911	341, 344, 347, 353, 355	M1282-9904	340	M1335-0810	342
5920 746 006	210	6001 021 110	286	6135 011 000	234, 235, 236, 237, 243	6731 000 521	329	F660320001	278	M1191-9912	347, 355	M1282-9905	353, 340	M1352-0002	345
5920 747 002	210	6001 021 210	286	6135 928 001	235, 236, 245	6731 000 841	329	F740320011	278	M1191-9913	347, 355	M1282-9906	353, 340	M1352-0006	345
5920 748 009	210	6001 021 310	286	6136 000 002	236	6731 000 851	329	F740320021	278	M1191-9914	347, 355	M1282-9907	353, 340	M1353-0002	344
5920 749 005	212	6001 021 410	286	6136 000 800	236	6731 001 011	329	F740320031	278	M1192-9901	342, 343, 345, 348	M1282-9908	353, 340	M1353-0006	344
5920 750 003	212	6001 021 910	286	6136 005 004	389	6731 001 021	329	F740320041	278	M1194-0002	348	M1282-9909	353, 340	P0625-2100	279
5920 751 000	210	6001 022 210	286	6137 000 006	237	6731 001 041	329	F740320111	278	M1194-0012	348	M1282-9913	353, 340	P0625-2110	279
5920 752 006	213	6001 022 310	286	6137 000 901	237	6731 001 051	329	F740320131	278	M1194-9903	353, 355, 342, 343, 345, 348	M1282-9915	340	P0625-2111	279
5920 753 002	210	6001 022 410	286	6137 005 008	389	6731 001 081	329	F740340011	278	M1194-9904	353, 355, 342, 343, 345, 348	M1282-9921	340	P0628-5000	333
5920 760 009	223	6001 022 910	286	6137 928 009	237, 245	6731 001 091	329	F740340021	278	M1194-9905	353, 355, 342, 343, 345, 348	M1282-9922	340	P0628-5060	333
5920 761 005	223	6001 040 010	287	6138 000 018	241	6731 001 341	329	F740340031	278	M1194-9906	353, 355, 342, 343, 345, 348	M1282-9925	340	P0628-5080	325
5920 762 001	223	6001 040 011	287	6301 000 012	248	6731 001 351	329	K0641-1690	287	M1194-9907	353, 355, 342, 343, 345, 348	M1282-9926	340	P0628-5940	325
5920 763 008	223	6001 040 110	287	6303 000 010	248	6731 001 811	329	K0641-1700	287	M1194-9908	353, 355, 342, 343, 345, 348	M1289-0001	351	P0628-6140	329
5920 764 004	223	6001 040 111	287	6305 000 017	248	6731 001 821	329	K0641-1750	287	M1194-9909	342, 343, 345, 348	M1289-0002	351	P0628-6150	333
5920 765 000	223	6001 040 210	287	6306 000 010	248	6731 070 085	329	K0641-1880	287	M1194-9910	342, 343, 345, 348	M1289-0003	351	P0628-6181	332
5920 766 007	223	6001 040 211	287	6311 000 010	248	6731 070 093	329	K0641-1890	287	M1194-9912	348	M1289-0004	351	P0628-6260	329
5920 767 003	223	6001 050 010	287	6313 000 018	248	6731 080 013	329	K0641-1900	287	M1194-9915	355	M1289-0005	351	P0628-6390	329
5920 768 000	223	6001 050 011	287	6315 000 015	248	6734 000 011	330	K0641-3000	287	M1194-9916	355	M1289-0006	351	P0628-6502	332
5920 769 006	223	6001 050 110	287	6316 000 019	248	ACE-1000S	353, 355	K0641-3001	287	M1194-9917	355	M1289-0010	351	P0628-6831	333
5920 770 004	223	6001 050 111	287	6321 897 000	390	ACE-10S	353, 355	K0641-3002	287	M1194-9918	355	M1289-0020	351	P0628-7880	333
5920 771 000	223	6001 050 210	287	6321 897 507	390	ACE-2000S	353, 355	K0641-3003	287	M1194-9919	355, 348	M1289-0030	351	P0628-7881	333
5942 000 010	194	6001 050 211	287	6328 006 500	251	ACE-3000S	353, 355	K0641-3004	287	M1194-9920	355, 348	M1289-0040	351	P0628-7890	333
5942 000 016	429	6001 061 210	285	6328 007 000	251	ACE-4000S	353, 355	K0641-3005	287	M1194-9921	348	M1289-0050	351	PTL-393	347
5942 000 210	429	6001 061 310	285	6328 007 507	251	ACE-5000S	353, 355	K0660-0051	279	M1194-9922	348	M1289-0060	351	S41I230011	332
5942 000 215	198	6001 061 410	285	6328 008 007	251	ACE-6000S	353, 355	M1001-0240	349	M1194-9923	342, 343, 345, 348	M1289-0100	351	S44I040001	339
5942 000 315	198	6001 061 510	285	6328 008 503	251	ACFE-2800S	353, 355	M11001-9920	349	M1194-9924	347, 348	M1289-0200	351	S44I040002	353, 339
5942 000 318	429	6001 061 910	285	6328 009 003	251	ACSB-1000S	351, 353, 355	M1194-9916	355	M1194-9925	348	M1289-0300	351	S44I040003	353, 339
5942 000 410	198	6001 062 210	285	6328 009 500	251	ACSB-500S	351, 353, 355	M1194-9917	355	M1194-9926	348	M1289-0400	351	S44I040004	353, 339
5942 000 415	429	6001 062 310	285	6330 000 013	252	AG-00	341, 344, 347, 353, 355	M1190-0002	349	M1194-9927	348	M1289-0500	351	S44I040005	353, 339
5942 000 512	429	6001 062 410	285	6331 000 017	252	AG-1	341, 344, 347, 353, 355	M1190-0012	349	M1194-9928	348	M1289-0600	351	S44I040006	353, 339
5942 000 515	198	6001 062 510	285	6332 000 010	252	AG-2	341, 344, 347, 353, 355	M1190-0300	355	M1194-9929	348	M1289-0700	353, 355, 351	S44I041001	339
5942 000 610	429	6001 062 910	285	6333 000 014	252	AG-21-00	347	M1190-9000	353, 355	M1194-9930	348	M1299-0082	343	S44I041002	339
5942 000 615	198	6001 071 110	286	6334 000 018	252	AG2-00	349	M1190-9001	353, 355	M1194-9931	348	M1299-0086	343	S44I041003	339
5942 000 710	198	6001 071 210	286	6335 000 011	252	AG2-UT	349	M1190-9002	353, 355	M1194-9932	348	M1299-0092	343	S44I041005	339
5942 000 717	429	6001 071 310	286	6336 000 015	253	B50-SQ	289	M1190-9004	353, 355	M1194-9933	348	M1299-0096	343	S44I041006	339
5948 000 010	194	6001 071 410	286	6337 000 019	253	B75-SQ	289	M1190-9005	353, 355	M1194-9934	348	M1320-0002	341	S44I042001	339
5948 000 018	430	6001 071 510	286	6338 000 012	253	B95-SQ	289	M1190-9900	349	M1194-9935	348	M1320-0006	341	S44I042002	339
5948 000 210	199	6001 071 910	286	6339 000 016	253	CO48300001	325	M1190-9902	349, 355	M1194-9936	348	M1320-0012	341	S44I300001	339
5948 000 212	430	6001 072 210	286	6345 000 010	252	CO48310001	325	M1190-9903	349, 355	M1194-9937	348	M1320-0016	341	S44I310001	339
5948 000 310	430	6001 072 310	286	6346 000 013	252	CO48310041	325	M1190-9904	349, 355	M1232-0101	350	M1320-0300	341	S44I311001	339
5948 000 315	199	6001 072 410	286	6347 000 017	252	CO48310061	325	M1190-9905	349, 355	M1232-0111	350	M1320-0400	341	S44I320001	339
5948 000 410	199	6001 072 510	286	6348 000 010	252	CO48312001	325	M1190-9906	349, 355	M1250-9504	332, 351	M1320-0500	341	S44I330001	339
5948 000 417	430	6001 072 910	286	6349 000 014	249	CO48312041	325	M1190-9907	349	M1250-9600	351	M1320-0600	341	S44I331001	339
5948 000 810	199	6001 081 110	286	6705 070 103	325	CO48312061	325	M1190-9908	349	M1250-9700	332, 351	M1320-8029	340, 341, 342, 343	TTR-210	351
5948 000 816	430	6001 081 210	286	6705 070 111	325	CO48320001	325	M1190-9909	349	M1250-9902	342, 343, 345, 348	M1334-9920	332	TTR-215	351
5948 000 910	199	6001 081 310	286	6705 070 120	325	CO48330001	325	M1190-9910	349	M1250-9903	353, 355, 342, 343, 345, 348	M1334-9921	332	TTR-221	353, 355, 351
5948 000 913	430	6001 081 410	286	6705 851 016	325	CO48332001	325	M1190-9911	349, 355	M1250-9904	353, 355, 341, 344, 347	M1334-9922	332	U9043-0002	279
6001 000 310	287	6001 081 510	286	6710 070 251	333	CO483332011	325	M1190-9915	349, 355	M1250-9906	342, 343, 345, 348, 351	M1334-9923	332	U9043-0004	279
6001 000 311	287	6001 081 910	286	6710 859 009	329	D100	289	M1190-9916	349, 355	M1250-9920	341, 344, 347	M1334-9924	332	U9043-0006	279
6001 000 410	287	6001 082 210	286	6710 859 106	329	D49	289	M1190-9917	349, 355	M1250-9921	347, 351	M1334-9925	332	U9043-0008	279
6001 000 411	287	6001 082 310	286	6731 000 011	329	D64	289	M1190-9918	349, 355	M1282-0002	340	M1334-9926	332	U9044-0002	279
6001 000 510	287	6001 082 410	286	6731 000 021	329	D81	289	M1190-9919	349, 355	M1282-0006	340	M1334-9927	332	U9044-0004	279
6001 000 910	287	6001 082 510	286	6731 000 041	329	F101340001	278	M1191-0002	347	M1282-0012	340	M1335-0002	342	U9044-0006	279
6001 000 911	287	6001 082 910	286	6731 000 051	329	F570300001	278	M1191-0012	347	M1282-0016	340	M1335-0006	342	U9044-0008	279
6001 011 110	285	6002 000 006	283	6731 000 111	329	F570320001	278	M1191-0022	347	M1282-0291	340	M1335-0012	342	U9260-0001	278
6001 011 210	285	6002 000 014	283	6731 000 121	329	F570320101	278	M1191-0032	347	M1282-0500	340	M1335-0016	342	U9260-0008	278
6001 011 310	285	6132 005 018	389	6731 000 211	329	F652999001	279	M1191-9904	347	M1282-0600	340	M1335-0080	342	U9400-0001	278
6001 011 410	285	6132 005 026	389	6731 000 221	329	F652999002	279	M1191-9905	347	M1282-0700	340	M1335-0300	342	U9410-0001	278
6001 011 510	285	6133 000 001	234	6731 000 311	329	F652999003	279	M1191-9908	341, 344, 347, 353, 355	M1282-0800	340	M1335-0400	342	U9425-0001	278
6001 011 910	285	6133 000 907	234	6731 000 321	32										

Order Numbers for Different Mains Voltage Versions



The following products are available in the listed mains voltage versions. For mains voltage versions for which no separate order number is listed, the valid order numbers are also those listed in the first column or in

the product description. The versions marked n.a. are not available. Order-related production is marked with *

Automated Liquid Handling

Power supply	Europe	UK/HKG	Australia	China	Japan	Argentina	ROW
epMotion® 96	5069 000 012	5069 000 020	5069 000 039	5069 000 047	5069 000 004	5069 000 055	5069 000 004
epMotion® 96 with 2-position slider	5069 000 110	5069 000 128	5069 000 136	5069 000 144	5069 000 101	5069 000 152	5069 000 101
epMotion® 96xl	5069 000 217	5069 000 225	5069 000 233	5069 000 241	5069 000 209	5069 000 250	5069 000 209
epMotion® 96xl with 2-position slider	5069 000 314	5069 000 322	5069 000 330	5069 000 349	5069 000 306	5069 000 357	5069 000 306
epMotion® 5070 EasyCon	5070 006 032	5070 007 002	5070 007 003	5070 007 004	5070 007 001	5070 007 005	5070 007 001
epMotion® 5070f EasyCon	5070 006 108	5070 007 102	5070 007 103	5070 007 104	5070 007 101	5070 007 105	5070 007 101
epMotion® 5070 MultiCon	5070 000 282	5070 007 012	5070 007 013	5070 007 014	5070 007 011	5070 007 015	5070 007 011
epMotion® 5070f MultiCon	5070 000 283	5070 007 112	5070 007 113	5070 007 114	5070 007 111	5070 007 115	5070 007 111
epMotion® P5073	5073 000 000	5073 000 227	5073 000 035	5073 000 043	5073 000 019	5073 000 051	5073 000 019
epMotion® M5073	5073 000 205	5073 000 221	5073 000 230	5073 000 248	5073 000 507	5073 000 256	5073 000 213
epMotion® P5073c	5073 000 302	5073 007 202	5073 007 203	5073 007 204	5073 007 201	5073 007 205	5073 007 201
epMotion® M5073c	5073 000 400	5073 007 302	5073 007 303	5073 007 304	5073 000 515	5073 007 305	5073 007 301
epMotion® 5073l EasyCon	5073 000 582	5073 007 402	5073 007 403	5073 007 404	5073 007 401	5073 007 405	5073 007 401
epMotion® 5073l MultiCon	5073 000 590	5073 007 412	5073 007 413	5073 007 414	5073 007 411	5073 007 415	5073 007 411
epMotion® 5073lc EasyCon	5073 000 604	5073 007 502	5073 007 503	5073 007 504	5073 007 501	5073 007 505	5073 007 501
epMotion® 5073lc MultiCon	5073 000 612	5073 007 512	5073 007 513	5073 007 514	5073 007 511	5073 007 515	5073 007 511
epMotion® 5073m EasyCon	5073 000 787	5073 007 802	5073 007 803	5073 007 804	n.a.	5073 007 805	5073 007 801
epMotion® 5073m MultiCon	5073 000 795	5073 007 812	5073 007 813	5073 007 814	5073 000 884	5073 007 815	5073 007 811
epMotion® 5073mc EasyCon	5073 000 809	5073 007 902	5073 007 903	5073 007 904	n.a.	5073 007 905	5073 007 901
epMotion® 5073mc MultiCon	5073 000 817	5073 007 912	5073 007 913	5073 007 914	5073 000 892	5073 007 915	5073 007 911
epMotion® 5075l	5075 000 301	*	*	*	*	*	*
epMotion® 5075t	5075 000 302	*	*	*	*	*	*
epMotion® 5075t NGS solution	5075 000 962	*	*	*	*	*	*
epMotion® 5075tc NGS solution	5075 000 963	*	*	*	*	*	*
epMotion® 5075v	5075 000 303	*	*	*	*	*	*
epMotion® 5075vt	5075 000 304	*	*	*	*	*	*
epMotion® 5075m	5075 000 305	*	*	*	*	*	*
epMotion® 5073m EasyCon NGS solution	5073 000 930	*	*	*	*	*	*
epMotion® 5073m MultiCon NGS solution	5073 000 949	*	*	*	*	*	*
epMotion® 5073mc EasyCon NGS solution	5073 000 957	*	*	*	*	*	*
epMotion® 5073mc MultiCon NGS solution	5073 000 965	*	*	*	*	*	*

Sample Preparation

Power supply	Europe	UK/HKG	Australia	China	Japan	Argentina	ROW
Eppendorf ThermoMixer® C, basic device without thermoblock	5382 000 015	5382 000 031	5382 000 066	5382 000 074	5382 000 023	5382 000 082	5382 000 023
Eppendorf ThermoMixer® F0.5, with thermoblock for 24 reaction vessels 0.5 mL	5386 000 010	5386 000 036	5386 000 060	5386 000 079	5386 000 028	5386 000 087	5386 000 028
Eppendorf ThermoMixer® F1.5, with thermoblock for 24 reaction vessels 1.5 mL	5384 000 012	5384 000 039	5384 000 063	5384 000 071	5384 000 020	5384 000 080	5384 000 020
Eppendorf ThermoMixer® F2.0, with thermoblock for 24 reaction vessels 2.0 mL	5387 000 013	5387 000 030	5387 000 064	5387 000 072	5387 000 021	5387 000 080	5387 000 021
Eppendorf ThermoMixer® FP, with thermoblock for Microplates and Deepwell Plates, including lid	5385 000 016	5385 000 032	5385 000 067	5385 000 075	5385 000 024	5385 000 083	5385 000 024
Eppendorf ThermoStat™ C, basic device without thermoblock	5383 000 019	5383 000 035	5383 000 060	5383 000 078	5383 000 027	5383 000 086	5383 000 027
MixMate®, basic device without tube holders	5353 000 510	5353 000 537	5353 000 545	5353 000 553	n.a.	n.a.	5353 000 022

Centrifuges and Rotors - General Lab Products

Power supply	Europe	UK/HKG	Australia	China	Japan	Argentina	ROW
Centrifuge MiniSpin® plus, with Rotor F-45-12-11	5453 000 015	5452 000 060	5453 000 089		5453 000 038	5453 000 054	n.a.
Centrifuge MiniSpin®, with Rotor F-45-12-11	5452 000 010	5453 000 060	5452 000 085		5452 000 034	5452 000 050	n.a.
Centrifuge 5418 R, with Rotor FA-45-18-11 and rotor lid	5401 000 010	5401 000 060	5401 000 080		5401 000 030	5401 000 056	5401 000 021
Centrifuge 5420, without rotor	5420 000 318	5420 000 369	5420 000 288		5420 000 237	5420 000 253	5420 000 229
Centrifuge 5420, with aerosol-tight Rotor FA-24x2	5420 000 113	5420 000 164	5420 000 083		5420 000 032	5420 000 059	5420 000 024
Centrifuge 5424 R, with Rotor FA-45-24-11	5404 000 010	5404 000 060	5404 000 081		5404 000 030	5404 000 057	5404 000 022
Centrifuge 5424 R, with Rotor FA-45-24-11	5404 000 410	5404 000 460	5404 000 480		5404 000 430	5404 000 456	5404 000 421
Centrifuge 5424 R, without rotor	5404 000 610	5404 000 265	5404 000 286		n.a.	5404 000 251	5404 000 227
Centrifuge 5424 R, without rotor	5404 000 210	5404 000 660	5404 000 685		5404 000 634	5404 000 650	5404 000 626
Centrifuge 5425, without rotor	5405 000 310	5405 000 360	5405 000 280		n.a.	5405 000 255	5405 000 220
Centrifuge 5425, without rotor	5405 000 719	5405 000 760	5405 000 689		5405 000 638	5405 000 654	5405 000 620
Centrifuge 5425, with Rotor FA-24x2	5405 000 115	5405 000 166	5405 000 085		n.a.	5405 000 050	5405 000 026
Centrifuge 5425, with Rotor FA-24x2	5405 000 514	5405 000 565	5405 000 484		5405 000 433	5405 000 450	5405 000 425
Centrifuge 5427 R, without rotor	5409 000 010	5409 000 060	5409 000 080		5409 000 039	5409 000 055	5409 000 020
Centrifuge 5427 R, with Rotor FA-45-12-17	5409 000 630	5409 000 660	5409 000 683		n.a.	5409 000 659	5409 000 624
Centrifuge 5427 R, with Rotor FA-45-30-11	5409 000 530	5409 000 565	5409 000 586		5409 000 519	5409 000 551	5409 000 527
Centrifuge 5427 R, with Rotor FA-45-48-11	5409 000 210	5409 000 260	5409 000 284		5409 000 233	5409 000 250	5409 000 225
Centrifuge 5430, without rotor	5427 000 015	5427 000 060	5427 000 089		5427 000 038	5427 000 054	5427 000 020
Centrifuge 5430, without rotor	5427 000 610	5427 000 660	5427 000 682		5427 000 631	5427 000 658	5427 000 623
Centrifuge 5430, with Rotor FA-45-30-11 incl. rotor lid	5427 000 210	5427 000 260	5427 000 283		5427 000 232	5427 000 259	5427 000 224
Centrifuge 5430, with Rotor FA-45-30-11 incl. rotor lid	5427 000 415	5427 000 465	5427 000 488		5427 000 437	5427 000 453	5427 000 429
Centrifuge 5430 R, without rotor	5428 000 205	5428 000 255	5428 000 287		5428 000 236	5428 000 252	5428 000 228
Centrifuge 5430 R, without rotor	5428 000 610	5428 000 655	5428 000 686		5428 000 635	5428 000 651	5428 000 627
Centrifuge 5430 R, with Rotor FA-45-30-11 and rotor lid	5428 000 010	5428 000 060	5428 000 082		5428 000 031	5428 000 058	5428 000 023
Centrifuge 5430 R, with Rotor FA-45-30-11 and rotor lid	5428 000 410	5428 000 460	5428 000 481		5428 000 430	5428 000 457	5428 000 422

Centrifuges and Rotors - General Lab Products

Power supply	Europe	UK/HKG	Australia	China	Japan	Argentina	ROW
Centrifuge 5702, without rotor	5702 000 010	5702 000 065	5702 000 086		5702 000 043	5702 000 051	5702 000 817
Centrifuge 5702, with Rotor A-4-38 incl. adapters for 15/50 mL conical tubes, 2 sets of 2 adapters	5702 000 320	5702 000 365	5702 000 388		n.a.	5702 000 353	5702 000 345
Centrifuge 5702 R, without rotor	5703 000 010	5703 000 060	5703 000 080		5703 000 039	5703 000 055	5703 000 047
Centrifuge 5702 R, with Rotor A-4-38 incl. adapters for 13/16 mm blood collection tubes, 2 sets of 2 adapters	5703 000 320	5703 000 360	5703 000 381		n.a.	5703 000 357	5703 000 349
Centrifuge 5702 R, with Rotor A-4-38 incl. adapters for 15/50 mL conical tubes, 2 sets of 2 adapters	5703 000 425	5703 000 460	5703 000 489		n.a.	5703 000 454	5703 000 470
Centrifuge 5702 RH, without rotor	5704 000 010	5704 000 060	5704 000 083		5704 000 032	5704 000 059	5704 000 040
Centrifuge 5804, without rotor	5804 000 010	5804 000 060	5804 000 080		n.a.	5804 000 056	5804 000 170
Centrifuge 5804 R, without rotor	5805 000 010	5805 000 060	5805 000 084		n.a.	5805 000 050	n.a.
Centrifuge 5804, with Rotor A-4-44 incl. adapters for 15/50 mL conical tubes	5804 000 320	5804 000 360	5804 000 382		*	5804 000 358	5804 000 374
Centrifuge 5804, with Rotor S-4-72 incl. adapters for 15/50 mL conical tubes	5804 000 520	5804 000 565	5804 000 587		*	5804 000 552	5804 000 544
Centrifuge 5804, with Rotor A-4-44 incl. adapters for 15/50 mL conical tubes	5804 000 320	5805 000 365	5805 000 386		*	5805 000 351	5805 000 378
Centrifuge 5804, with Rotor S-4-72 incl. adapters for 15/50 mL conical tubes	5804 000 520	5805 000 665	5805 000 688		*	5805 000 653	5805 000 645
Centrifuge 5810, without rotor	5810 000 010	5810 000 060	5810 000 084		n.a.	5810 000 050	5810 000 190
Centrifuge 5810 R, without rotor	5811 000 015	5811 000 065	5811 000 088		n.a.	5811 000 053	n.a.
Centrifuge 5810 R, with Rotor A-4-62 incl. adapters for 15/50 mL conical tubes	5811 000 325	5811 000 360	5811 000 380		*	5811 000 355	5811 000 371
Centrifuge 5810, with Rotor A-4-81 incl. adapters for 15/50 mL conical tubes	5810 000 420	5810 000 460	5810 000 483		*	5810 000 459	5810 000 475
Centrifuge 5810 R, with Rotor A-4-81 incl. adapters for 15/50 mL conical tubes	5811 000 420	5811 000 465	5811 000 487		*	5811 000 452	5811 000 479
Centrifuge 5810, with Rotor S-4-104 incl. adapters for 15/50 mL conical tubes	5810 000 525	5810 000 560	5810 000 580		*	5810 000 556	5810 000 548
Centrifuge 5810 R, with Rotor S-4-104 incl. adapters for 15/50 mL conical tubes	5811 000 620	5811 000 660	5811 000 681		*	5811 000 657	5811 000 649
Centrifuge 5810, with Rotor S-4-104 incl. adapters for 13/16 mm round-bottom tubes	5810 000 620	5810 000 665	5810 000 688		*	5810 000 653	5810 000 670
Centrifuge 5810, with Rotor A-4-62 incl. adapters for 15/50 mL conical tubes	5810 000 320	5810 000 365	5810 000 386		5810 000 378	5810 000 351	5810 000 378
Centrifuge 5810 R, with Rotor S-4-104 incl. adapters for 13/16 mm round-bottom tubes	5811 000 820	5810 000 665	5811 000 886		*	5811 000 851	5811 000 843
Centrifuge 5910 R, without rotor	5942 000 010	5942 000 060	5942 000 083		5942 000 032	5942 000 059	5942 000 024
Centrifuge 5910 R, with Rotor S-4xUniversal	5942 000 315	5942 000 360	5942 000 385		5942 000 334	5942 000 350	5942 000 326
Centrifuge 5910 R, with Rotor S-4xUniversal	5942 000 215	5942 000 265	5942 000 288		5942 000 229	5942 000 253	5942 000 229
Centrifuge 5910 R, with Rotor S-4xUniversal	5942 000 410	5942 000 460	5942 000 482		5942 000 431	5942 000 458	5942 000 423
Centrifuge 5910 R, with Rotor S-4x750	5942 000 515	5942 000 560	5942 000 580		5942 000 539	5942 000 555	5942 000 520
Centrifuge 5910 R, with Rotor S-4x500	5942 000 615	5942 000 665	5942 000 687		5942 000 636	5942 000 652	5942 000 628
Centrifuge 5910 R, with Rotor S-4x400	5942 000 710	5942 000 760	5942 000 784		5942 000 733	5942 000 750	5942 000 725
Centrifuge 5920 R, without rotor	5948 000 010	5948 000 060	5948 000 085			5948 000 050	5948 000 026
Centrifuge 5920 R, with Rotor S-4xUniversal-Large	5948 000 910	5948 000 960	5948 000 980			5948 000 956	5948 000 921
Centrifuge 5920 R, with Rotor S-4xUniversal-Large	5948 000 810	5948 000 860	5948 000 883			5948 000 859	5948 000 824
Centrifuge 5920 R, with Rotor S-4x1000	5948 000 210	5948 000 260	5948 000 280			5948 000 255	5948 000 220
Centrifuge 5920 R, with Rotor S-4x1000	5948 000 410	5948 000 460	5948 000 484			5948 000 450	5948 000 425
Centrifuge 5920 R, with Rotor S-4x1000	5948 000 315	5948 000 365	5948 000 387			5948 000 352	5948 000 328
Centrifuge 5920 R, with Rotor S-4x750	5948 000 510	5948 000 560	5948 000 581			5948 000 557	5948 000 522
Concentrator plus basic device	5305 000 100	5305 000 169	5305 000 185	5305 000 193	5305 000 142	5305 000 150	5305 000 177
Concentrator plus complete system	5305 000 304	5305 000 363	5305 000 380	5305 000 398	5305 000 347	5305 000 355	5305 000 371
Concentrator plus complete system	5305 000 509	5305 000 568	5305 000 584	5305 000 592	5305 000 541	5305 000 550	5305 000 576
Concentrator plus complete system	5305 000 703	5305 000 762	5305 000 589	5305 000 797	5305 000 746	5305 000 754	5305 000 770

Detection

Power supply	Europe	UK/HKG	Australia	China	Japan	Argentina	ROW
Eppendorf BioPhotometer® D30	6133 000 001	6133 000 028	6133 000 036	6133 000 044	6133 000 010	6133 000 052	6133 000 010
Eppendorf µCuvette® G1.0 and Eppendorf BioPhotometer® D30	6133 000 907	6133 000 909	6133 000 910	6133 000 911	6133 000 908	6133 000 912	6133 000 908
Eppendorf BioSpectrometer® basic	6135 000 009	6135 000 025	6135 000 033	6135 000 041	6135 000 017	6135 000 050	6135 000 050
Eppendorf BioSpectrometer® fluorescence	6137 000 006	6137 000 022	6137 000 030	6137 000 049	6137 000 014	6137 000 057	6137 000 014
Eppendorf µCuvette® G1.0 and Eppendorf BioSpectrometer® fluorescence	6137 000 901	6137 000 903	6137 000 904	6137 000 905	6137 000 902	6137 000 906	6137 000 902
Eppendorf BioSpectrometer® kinetic	6136 000 002	6136 000 029	6136 000 037	6136 000 045	6136 000 010	6136 000 053	6136 000 053
Eppendorf µCuvette® G1.0 and Eppendorf BioSpectrometer® kinetic	6136 000 800	6136 000 029	6136 000 827	6136 000 835	6136 000 851	6136 000 843	6136 000 851
Eppendorf µCuvette® G1.0 and Eppendorf BioSpectrometer® basic	6135 000 904	6135 000 906	6135 000 907	6135 000 908	6135 000 905	6135 000 909	6135 000 905
Thermal Printer DPU-S445	6135 011 000	6135 012 007	n.a.	n.a.	6135 010 004	n.a.	6135 011 000

PCR

Power supply	Europe	UK/HKG	Australia	China	Japan	Argentina	ROW
Mastercycler® nexus	6333 000 014	6333 000 049	6333 000 065	6333 000 073	6333 000 030	n.a.	6333 000 030
Mastercycler® nexus eco	6332 000 010	6332 000 045	6332 000 061	6332 000 070	6332 000 037	n.a.	6332 000 037
Mastercycler® nexus gradient	6331 000 017	6331 000 041	6331 000 068	6331 000 076	6331 000 033	n.a.	6331 000 033
Mastercycler® nexus flat	6335 000 011	6335 000 046	6335 000 062	6335 000 070	6335 000 038	6335 000 089	6335 000 038
Mastercycler® nexus flat eco	6330 000 013	6330 000 048	6330 000 064	6330 000 072	6330 000 021	6330 000 080	6330 000 021
Mastercycler® nexus GSX1	6345 000 010	6345 000 044	6345 000 060	6345 000 079	6345 000 028	6345 000 087	6345 000 028
Mastercycler® nexus GSX1e	6347 000 017	6347 000 041	6347 000 068	6347 000 076	6347 000 025	6347 000 084	6347 000 025
Mastercycler® nexus SX1e	6348 000 010	6348 000 045	6348 000 061	6348 000 070	6348 000 029	6348 000 088	6348 000 029
Mastercycler® nexus SX1	6346 000 013	6346 000 048	6346 000 064	6346 000 072	6346 000 021	6346 000 080	6346 000 021
Mastercycler® nexus GX2	6336 000 015	6336 000 040	6336 000 066	6336 000 074	n.a.	6336 000 082	6336 000 023
Mastercycler® nexus GX2e	6338 000 012	6338 000 047	6338 000 063	6338 000 071	n.a.	6338 000 080	6338 000 020
Mastercycler® nexus X2	6337 000 019	6337 000 043	6337 000 060	6337 000 078	6337 000 027	6337 000 086	n.a.
Mastercycler® nexus X2e	6339 000 016	6339 000 040	6339 000 067	6339 000 075	n.a.	6339 000 083	6339 000 024
Mastercycler® X50s	6311 000 010	6311 000 045	6311 000 061	6311 000 070	n.a.	6311 000 088	n.a.
Mastercycler® X50a	6313 000 018	6313 000 042	6313 000 069	6313 000 077	n.a.	6313 000 085	n.a.
Mastercycler® X50p	6315 000 015	6315 000 040	6315 000 066	6315 000 074	n.a.	n.a.	n.a.
Mastercycler® X50h	6316 000 019	6316 000 043	6316 000 060	6316 000 078	n.a.	6316 000 086	n.a.
Mastercycler® X50i	6301 000 012	6301 000 047	6301 000 063	6301 000 071	n.a.	6301 000 080	n.a.
Mastercycler® X50l	6303 000 010	6303 000 044	6303 000 060	6303 000 079	n.a.	6303 000 087	n.a.
Mastercycler® X50r	6305 000 017	6305 000 041	6305 000 068	6305 000 076	n.a.	6305 000 084	n.a.
Mastercycler® X50t	6306 000 010	6306 000 045	6306 000 061	6306 000 070	n.a.	6306 000 088	n.a.
HeatSealer S100, incl. PCR Plate Adapter	5391 000 001	5391 000 036	5391 000 044	5391 000 060	n.a.	5391 000 079	5391 000 010
HeatSealer S200, incl. PCR Plate Adapter	5392 000 005	5392 000 030	5392 000 048	5392 000 064	n.a.	5392 000 072	5392 000 013

Freezers

Power supply	230 V, 50 Hz	120 V, 60 Hz	208-230 V, 60 Hz	120-220 V, 60 Hz
CryoCube® F570, with LED interface, classic cooling liquids, and air-cooling	F570300001	F570200005	F570400005	
CryoCube® F570h, with LED interface, green cooling liquids, and air-cooling	F570320001	F570220005		
CryoCube® F570hw, with LED interface, green cooling liquids, and water-cooling	F570320101			
Innova® U535, with LED interface, classic cooling liquids, and air-cooling	U9430-0001	U9430-0000	U9430-0002	
HEF® U410, with LED interface, green cooling liquids, and air-cooling	U9260-0008	U9260-0007		
Premium U410, with LED interface, classic cooling liquids, and air-cooling	U9260-0001	U9260-0000	U9260-0002	
Innova® U360, with LED interface, classic cooling liquids, and air-cooling	U9425-0001	U9425-0000		
Innova® C760, with LED interface, classic cooling liquids, and air-cooling	U9410-0001		U9410-0002	
CryoCube® FC660, with LED interface, classic cooling liquids, and air-cooling	F660300001		F660400005	
Innova® C585, with LED interface, classic cooling liquids, and air-cooling	U9400-0001	U9400-0000	U9400-0002	
CryoCube® FC660h, with LED interface, green cooling liquids, and air-cooling	F660320001		F660420005	
CO ₂ back-up system, narrow version	U9043-0004			U9043-0002
LN ₂ back-up system, narrow version	U9044-0004			U9044-0002
CO ₂ back-up system, premium version	U9043-0008			
LN ₂ back-up system, premium version	U9044-0008			U9044-0006

Power supply	Europe	UK/HKG	Australia	China	USA	Japan
CryoCube® F101h, with LED interface, green cooling liquids, and air-cooling	F101340001	F101340002	F101340003	F101340004	F101240005	–
CryoCube® F740h, 3c., with LED interface, green cooling liquids, and air-cooling, 100 – 240 V					F740540015	
CryoCube® F740h, 3c., with LED interface, green cooling liquids, and air-cooling	F740340011	F740340012	F740340013	F740340014		F740040016
CryoCube® F740h, 3c., with LED interface, green cooling liquids, and air-cooling, 100 – 240 V					F740540024	
CryoCube® F740h, 3c., with LED interface, green cooling liquids, and air-cooling	F740340021	F740340022	F740340023	F740340024		F740040026
CryoCube® F740h, 5c., with LED interface, green cooling liquids, and air-cooling, 100 – 240 V					F740540035	
CryoCube® F740h, 5c., with LED interface, green cooling liquids, and air-cooling	F740340031	F740340032	F740340033	F740340034		F740400036
CryoCube® F740h, 3c., with LED interface, green cooling liquids, and air-cooling, 100 – 240 V					F740540025	
CryoCube® F740h, 3c., with LED interface, green cooling liquids, and air-cooling	F740340021	F740340022	F740340023	F740340024		F740040026
CryoCube® F740hi, 5 c., with touchscreen interface, green cooling liquids, and air-cooling, 110 – 120 V					F740220035	
CryoCube® F740hi, 5 c., with touchscreen interface, green cooling liquids, and air-cooling, 208 V					F740420035	
CryoCube® F740hi, 5 c., with touchscreen interface, green cooling liquids, and air-cooling	F740320031	F740320032	F740320033	F740320034		F740020036
CryoCube® F740hi, 3 c., with touchscreen interface, green cooling liquids, and air-cooling, 110 – 120 V					F740220015	
CryoCube® F740hi, 3 c., with touchscreen interface, green cooling liquids, and air-cooling, 208 V					F740420015	
CryoCube® F740hi, 3 c., with touchscreen interface, green cooling liquids, and air-cooling	F740320011	F740320012	F740320013	F740320014		F740020016
CryoCube® F740hiw, 5 c., with touchscreen interface, green cooling liquids, and water-cooling, 110 – 120 V					F740220135	
CryoCube® F740hiw, 5 c., with touchscreen interface, green cooling liquids, and water-cooling, 208 V					F740420135	
CryoCube® F740hiw, 5 c., with touchscreen interface, green cooling liquids, and water-cooling	F740320131	F740320132	F740320133	F740320134		F740020136
CryoCube® F740hiw, 3 c., with touchscreen interface, green cooling liquids, and water-cooling, 110 – 120 V					F740220115	
CryoCube® F740hiw, 3 c., with touchscreen interface, green cooling liquids, and water-cooling, 208 V					F740420115	
CryoCube® F740hiw, 3 c., with touchscreen interface, green cooling liquids, and water-cooling	F740320111	F740320112	F740320113	F740320114		F740020116

Cell Technology

Power supply	Europe	UK/HKG	Australia	China	Japan	Argentina	ROW
Eppendorf Eporator®, for bacteria and yeasts	4309 000 019	4309 000 035	4309 000 051	4309 000 060	4309 000 027	4309 000 078	n.a.
Eppendorf PiezoXpert®, for piezo-assisted micromanipulation, incl. actuator 2, foot control and spacer plate and grip head 4 size 0	5194 000 016	5194 000 032	5194 000 059	5194 000 067	5194 000 024	5194 000 075	n.a.
FemtoJet® 4x, programmable microinjector with external pressure supply (not included)	5253 000 017	5253 000 033	5253 000 050	5253 000 068	5253 000 025	5253 000 076	n.a.
FemtoJet® 4i, programmable microinjector with integrated pressure supply	5252 000 013	5252 000 030	5252 000 056	5252 000 064	5252 000 021	5252 000 072	n.a.
InjectMan® 4, micromanipulator with dynamic movement control	5192 000 019	5192 000 035	5192 000 043	5192 000 051	5192 000 027	5192 000 060	–
TransferMan® 4m, micromanipulator with DualSpeed™ joystick for direct and dynamic movement control	5191 000 015	5191 000 031	–	–	–	–	–
TransferMan® 4r, micromanipulator with DualSpeed™ joystick for direct and dynamic movement control	5193 000 012	5193 000 039	5193 000 047	5193 000 055	5193 000 020	5193 000 063	–

Incubator

Power supply	Europe	UK/HKG	Australia	China	ROW
Galaxy® 48 R, Standard	CO48300001	CO48300002	CO48300003	CO48300004	CO48200005
Galaxy® 48 R, 1 – 19 % O ₂ Control	CO48320001	CO48320002	CO48300003	CO48320004	CO48220005
Galaxy® 48 R, High-Temp Disinfection	CO48310001	CO48310002	CO48310003	CO48310004	CO48210005
Galaxy® 48 R, High-Temp Disinfection, 1 – 19 % O ₂ Control	CO48330001	CO48330002	CO48330003	CO48330004	CO48230005
Galaxy® 48 R, High-Temp Disinfection, 2-Split Inner Door	CO48312001	CO48312002	CO48312003	CO48312004	CO48212005
Galaxy® 48 R, High-Temp Disinfection, 0.1 – 19 % O ₂ Control	CO48310041	CO48310042	CO48310043	CO48310044	CO48210045
Galaxy® 48 R, High-Temp Disinfection, 0.1 – 19 % O ₂ Control, Humidity Package	CO48310061	CO48310062	CO48310063	CO48310064	CO48210065
Galaxy® 48 R, High-Temp Disinfection, 0.1 – 19 % O ₂ Control, 2-Split Inner Door	CO48312041	CO48312042	CO48312043	CO48312044	CO48212045
Galaxy® 48 R, High-Temp Disinfection, 0.1 – 19 % O ₂ Control, 2-Split Inner Door, Humidity Package	CO48312061	CO48312062	CO48312063	CO48312064	CO48212065
Galaxy® 48 R, High-Temp Disinfection, 1 – 19 % O ₂ Control, 2-Split Inner Door	CO48332001	CO48332002	CO48332003	CO48332004	CO48232005
Galaxy® 48 R, High-Temp Disinfection, 1 – 19 % O ₂ Control, 2-Split Inner Door, Humidity Package	CO48332011	CO48332012	CO48332013	CO48332014	CO48232015

Power supply	Europe	UK/HKG	Australia	China	ROW
C170, Std, Right, 230 V EU	6734 000 011	6734 000 012	6734 000 013	6734 000 014	6734 010 015
C170i, Std, Right, 230 V EU	6731 000 011	6731 000 012	6731 000 013	6731 000 014	6731 010 015
C170i, Std, Right, Copper, 230 V EU	6731 000 511	6731 000 512	6731 000 513	6731 000 514	6731 010 515
C170i, Std, Right, O ₂ , 230 V EU	6731 001 011	6731 001 012	6731 001 013	6731 001 014	6731 011 015
C170i, Std, Left, 230 V EU	6731 000 021	6731 000 022	6731 000 023	6731 000 024	6731 010 025
C170i, Std, Left, Copper, 230 V EU	6731 000 521	6731 000 522	6731 000 523	6731 000 524	6731 010 525
C170i, Std, Left, O ₂ , 230 V EU	6731 001 021	6731 001 022	6731 001 023	6731 001 024	6731 011 025

Power supply	Europe	UK/HKG	Australia	China	ROW
New Brunswick™ S41i	S411230011	S411230012	S411230013	S411230014	S41120010

Shakers

Power supply	230 V, 50 Hz	120 V, 60 Hz	100 V, 60 Hz	100 V, 50 Hz
New Brunswick™ Innova® 40, 1.9 cm (3/4 in)	M1299-0082	M1299-0080	M1299-0081	M1299-0083
New Brunswick™ Innova® 40, 2.5 cm (1 in)	M1299-0092	M1299-0090	M1299-0091	M1299-0093
New Brunswick™ Innova® 40R, 1.9 cm (3/4 in)	M1299-0086	M1299-0084	M1299-0085	M1299-0087
New Brunswick™ Innova® 40R, 2.5 cm (1 in)	M1299-0096	M1299-0094	M1299-0095	M1299-0097
New Brunswick™ Innova® 42, 1.9 cm (3/4 in)	M1335-0002	M1335-0000	M1335-0001	M1335-0003
New Brunswick™ Innova® 42, 2.5 cm (1 in)	M1335-0012	M1335-0010	M1335-0011	M1335-0013
New Brunswick™ Innova® 42R, 1.9 cm (3/4 in)	M1335-0006	M1335-0004	M1335-0005	M1335-0007
New Brunswick™ Innova® 42R, 2.5 cm (1 in)	M1335-0016	M1335-0014	M1335-0015	M1335-0017
New Brunswick™ Innova® 43, 2.5 cm (1 in)	M1320-0002	M1320-0000	M1320-0001	M1320-0003
New Brunswick™ Innova® 43, 5.1 cm (2 in)	M1320-0012	M1320-0010	M1320-0011	M1320-0013
New Brunswick™ Innova® 43R, 2.5 cm (1 in)	M1320-0006	M1320-0004	M1320-0005	M1320-0007
New Brunswick™ Innova® 43R, 5.1 cm (2 in)	M1320-0016	M1320-0014	M1320-0015	M1320-0017
New Brunswick™ Innova® 44, 2.5 cm (1 in)	M1282-0002	M1282-0000	M1282-0001	M1282-0003
New Brunswick™ Innova® 44, 5.1 cm (2 in)	M1282-0012	M1282-0010	M1282-0011	M1282-0013
New Brunswick™ Innova® 44R, 2.5 cm (1 in)	M1282-0006	M1282-0004	M1282-0005	M1282-0007
New Brunswick™ Innova® 44R, 5.1 cm (2 in)	M1282-0016	M1282-0014	M1282-0015	M1282-0017
New Brunswick™ Excella® E24, 1.9 cm (3/4 in)	M1352-0002	M1352-0000	M1352-0001	
New Brunswick™ Excella® E24R, 1.9 cm (3/4 in)	M1352-0006	M1352-0004	M1352-0005	
New Brunswick™ Excella® E25, 2.5 cm (1 in)	M1353-0002	M1353-0000	M1353-0001	M1353-0003
New Brunswick™ Excella® E25R, 2.5 cm (1 in)	M1353-0006			

Power supply	Europe	UK/HKG	Australia	China	Japan	Argentina	Brazil	ROW
Innova® S44i, 2.5 cm (1 in) orbit, 2.5 cm (1 in)	S441300001	S441i331002	S441300003	S441300004	S441000006	S441300008	S441300009	S441200005
Innova® S44i, 2.5 cm (1 in) orbit, 2.5 cm (1 in)	S441310001	S441i331002	S441310003	S441310004	S441010006	S441310008	S441310009	S441210005
Innova® S44i, 2.5 cm (1 in) orbit, 2.5 cm (1 in)	S441311001	S441i331002	S441311003	S441311004		S441311008	S441311009	S441211005
Innova® S44i, 5.1 cm (2 in) orbit, 5.1 cm (2 in)	S441320001	S441i331002	S441320003	S441320004	S441020006	S441320008	S441320009	S441220005
Innova® S44i, 5.1 cm (2 in) orbit, 5.1 cm (2 in)	S441330001	S441i331002	S441330003	S441330004	S441030006	S441330008	S441330009	S441230005
Innova® S44i, 5.1 cm (2 in) orbit, 5.1 cm (2 in)	S441331001	S441i331002	S441331003	S441331004		S441331008	S441331009	S441231005

Power supply	230 V, 50 Hz	230 V, 50/60 Hz	220/230 V, 50/60 Hz	230/240 V, 50/60 Hz	240 V, 50/60 Hz
New Brunswick™ Innova® 2000, 1.9 cm (0.75 in)	n.a.	n.a.	M1190-0002	n.a.	M1190-0003
New Brunswick™ Innova® 2050, 1.9 cm (0.75 in)	n.a.	n.a.	M1190-0012	n.a.	M1190-0013
New Brunswick™ Innova® 2100, 1.9 cm (0.75 in)	n.a.	n.a.	M1194-0002	n.a.	M1194-0003
New Brunswick™ Innova® 2150, 1.9 cm (0.75 in)	n.a.	n.a.	M1194-0012	n.a.	M1194-0013
New Brunswick™ Innova® 2300, 2.5 cm (1 in)	n.a.	n.a.	M1191-0002	n.a.	M1191-0003
New Brunswick™ Innova® 2300, 5.1 cm (2 in)	n.a.	n.a.	M1191-0022	n.a.	M1191-0023
New Brunswick™ Innova® 2350, 2.5 cm (1 in)	n.a.	n.a.	M1191-0012	n.a.	M1191-0013
New Brunswick™ Innova® 2350, 5.1 cm (2 in)	n.a.	n.a.	M1191-0032	n.a.	M1191-0033
New Brunswick™ Innova® 5000, 5.1 cm (2 in)	n.a.	n.a.	M1196-0002	n.a.	M1196-0003
New Brunswick™ Innova® 5050 Rack System	n.a.	n.a.	*	M1232-0101	*
New Brunswick™ Innova® 5051 Rack Extension	n.a.	n.a.	*	M1232-0111	*

Shakers

Power supply	120 V, 60 Hz	120 V, 50/60 Hz	100/120 V, 50/60 Hz	100 V, 60 Hz	100 V, 50 Hz	100 V, 50/60 Hz
New Brunswick™ Innova® 2000, 1.9 cm (0.75 in)		M1190-0000				M1190-0001
New Brunswick™ Innova® 2050, 1.9 cm (0.75 in)		M1190-0010				M1190-0011
New Brunswick™ Innova® 2100, 1.9 cm (0.75 in)		M1194-0000				M1194-0001
New Brunswick™ Innova® 2150, 1.9 cm (0.75 in)		M1194-0010				M1194-0011
New Brunswick™ Innova® 2300, 2.5 cm (1 in)		M1191-0000				M1191-0001
New Brunswick™ Innova® 2300, 5.1 cm (2 in)		M1191-0020				M1191-0021
New Brunswick™ Innova® 2350, 2.5 cm (1 in)		M1191-0010				M1191-0011
New Brunswick™ Innova® 2350, 5.1 cm (2 in)		M1191-0030				M1191-0031
New Brunswick™ Innova® 5050 Rack System			M1232-0100			
New Brunswick™ Innova® 5051 Rack Extension			M1232-0110			

Centrifuges and Rotors - EU-IVD Products

Power supply	Europe	UK	Australia	China ¹⁾	Japan	Argentina	ROW
Centrifuge MiniSpin® plus, with Rotor F-45-12-11	5453 000 011	5452 000 069		5452 000 093			
Centrifuge MiniSpin®, with Rotor F-45-12-11	5452 000 018	5453 000 062		5453 000 097			
Centrifuge 5418 R, with Rotor FA-45-18-11 and rotor lid	5401 000 013	5401 000 064		5401 000 099			
Centrifuge 5420, without rotor	5420 000 210	5420 000 261		5420 000 296			
Centrifuge 5420, with aerosol-tight Rotor FA-24x2	5420 000 016	5420 000 067		5420 000 091			
Centrifuge 5424 R, with Rotor FA-45-24-11	5404 000 014	5404 000 065		5404 000 090			
Centrifuge 5424 R, with Rotor FA-45-24-11	5404 000 413	5404 000 464		5404 000 499			
Centrifuge 5424 R, without rotor	5404 000 219	5404 000 260		5404 000 294			
Centrifuge 5424 R, without rotor	5404 000 618	5404 000 669		5404 000 693			
Centrifuge 5427 R, without rotor	5409 000 012	5409 000 063		5409 000 098			
Centrifuge 5427 R, with Rotor FA-45-12-17	5409 000 632	5409 000 667		5409 000 691			
Centrifuge 5427 R, with Rotor FA-45-30-11	5409 000 535	5409 000 560		5409 000 594			
Centrifuge 5427 R, with Rotor FA-45-48-11	5409 000 217	5409 000 268		5409 000 292			
Centrifuge 5430 R, with Rotor FA-45-30-11 incl. rotor lid	5428 000 015	5428 000 066		5428 000 090			
Centrifuge 5430 R, with Rotor FA-45-30-11 incl. rotor lid	5428 000 414	5428 000 465		5428 000 490			
Centrifuge 5430 R, without rotor	5428 000 210	5428 000 260		5428 000 295			
Centrifuge 5430 R, without rotor	5428 000 619	5428 000 660		5428 000 694			
Centrifuge 5430, with Rotor FA-45-30-11 incl. rotor lid	5427 000 216	5427 000 267		5427 000 291			
Centrifuge 5430, with Rotor FA-45-30-11 incl. rotor lid	5427 000 410	5427 000 461		5427 000 496			
Centrifuge 5430, without rotor	5427 000 011	5427 000 062		5427 000 097			
Centrifuge 5430, without rotor	5427 000 615	5427 000 666		5427 000 690			

¹⁾ Listed articles (except for Centrifuge 5920 R) registered as medical devices class 1 in China.

Power supply	Europe	UK	Australia	China ¹⁾	Japan	Argentina	ROW
Centrifuge 5702, with Rotor A-4-38 incl. adapters for 15/50 mL conical tubes, 2 sets of 2 adapters	5702 000 329	5702 000 361		5702 000 396			
Centrifuge 5702 R, with Rotor A-4-38 incl. adapters for 15/50 mL conical tubes, 2 sets of 2 adapters	5703 000 420	5703 000 462		5703 000 497			
Centrifuge 5702 R, with Rotor A-4-38 incl. adapters for 13/16 mm blood collection tubes, 2 sets of 2 adapters	5703 000 322	5703 000 365		5703 000 390			
Centrifuge 5702 R, without rotor	5703 000 012	5703 000 063		5703 000 098			
Centrifuge 5702 RH, without rotor	5704 000 016	5704 000 067		5704 000 091			
Centrifuge 5702, without rotor	5702 000 019	5702 000 060		5702 000 094			
Centrifuge 5804, with Rotor A-4-44 incl. adapters for 15/50 mL conical tubes	5804 000 323	5804 000 366		5804 000 390			
Centrifuge 5804, with Rotor S-4-72 incl. adapters for 15/50 mL conical tubes	5804 000 528	5804 000 560		5804 000 595			
Centrifuge 5804 R, with Rotor A-4-44 incl. adapters for 15/50 mL conical tubes	5805 000 327	5805 000 360		5805 000 394			
Centrifuge 5804 R, with Rotor S-4-72 incl. adapters for 15/50 mL conical tubes	5805 000 629	5805 000 661		5805 000 696			
Centrifuge 5804 R, without rotor	5805 000 017	5805 000 068		5805 000 092			
Centrifuge 5804, without rotor	5804 000 013	5804 000 064		5804 000 099			
Centrifuge 5810, with Rotor A-4-62 incl. adapters for 15/50 mL conical tubes	5810 000 327	5810 000 360		5810 000 394			
Centrifuge 5810, with Rotor A-4-81 incl. adapters for 15/50 mL conical tubes	5810 000 424	5810 000 467		5810 000 491			
Centrifuge 5810, with Rotor S-4-104 incl. adapters for 15/50 mL conical tubes	5810 000 521	5810 000 564		5810 000 599			
Centrifuge 5810, with Rotor S-4-104 incl. adapters for 13/16 mm round-bottom tubes	5810 000 629	5810 000 661		5810 000 696			
Centrifuge 5810 R, with Rotor A-4-62 incl. adapters for 15/50 mL conical tubes	5811 000 320	5811 000 363		5811 000 398			
Centrifuge 5810 R, with Rotor A-4-81 incl. adapters for 15/50 mL conical tubes	5811 000 428	5811 000 460		5811 000 495			
Centrifuge 5810 R, with Rotor S-4-104 incl. adapters for 15/50 mL conical tubes	5811 000 622	5811 000 665		5811 000 690			
Centrifuge 5810 R, with Rotor S-4-104 incl. adapters for 13/16 mm round-bottom tubes	5811 000 827	5811 000 860		5811 000 894			
Centrifuge 5810 R, without rotor	5811 000 010	5811 000 061		5811 000 096			
Centrifuge 5810, without rotor	5810 000 017	5810 000 068		5810 000 092			
Centrifuge 5910 R, without rotor	5942 000 016	5942 000 067		5942 000 091			
Centrifuge 5910 R, with Rotor S-4xUniversal	5942 000 210	5942 000 261		5942 000 296			
Centrifuge 5910 R, with Rotor S-4xUniversal	5942 000 318	5942 000 369		5942 000 393			
Centrifuge 5910 R, with Rotor S-4xUniversal	5942 000 415	5942 000 466		5942 000 490			
Centrifuge 5910 R, with Rotor S-4x750	5942 000 512	5942 000 563		5942 000 598			
Centrifuge 5910 R, with Rotor S-4x500	5942 000 610	5942 000 660		5942 000 695			
Centrifuge 5910 R, with Rotor S-4x400	5942 000 717	5942 000 768		5942 000 792			
Centrifuge 5920 R	5948 000 018	5948 000 069		5948 000 093			
Centrifuge 5920 R, with Rotor S-4x1000	5948 000 212	5948 000 263		5948 000 298			
Centrifuge 5920 R, with Rotor S-4x1000	5948 000 310	5948 000 360		5948 000 395			
Centrifuge 5920 R, with Rotor S-4x1000	5948 000 417	5948 000 468		5948 000 492			
Centrifuge 5920 R, with Rotor S-4xUniversal-Large	5948 000 816	5948 000 867		5948 000 891			
Centrifuge 5920 R, with Rotor S-4xUniversal-Large	5948 000 913	5948 000 964		5948 000 999			

¹⁾ Listed articles (except for Centrifuge 5920 R) registered as medical devices class 1 in China.

ALBANIA*

Eppendorf Austria GmbH
Ignaz Köck Straße 10/2. OG
1210 Wien
AUSTRIA
Tel: +43 (0) 1 890 13 64 - 0
Fax: +43 (0) 1 890 13 64 - 20
office@eppendorf.at
www.eppendorf.at

ARMENIA

Eppendorf Austria GmbH
Ignaz Köck Straße 10/2. OG
1210 Wien
AUSTRIA
Tel: +43 (0) 1 890 13 64 - 0
Fax: +43 (0) 1 890 13 64 - 20
office@eppendorf.at
www.eppendorf.at

AZERBAIJAN

Eppendorf Austria GmbH
Ignaz Köck Straße 10/2. OG
1210 Wien
AUSTRIA
Tel: +43 (0) 1 890 13 64 - 0
Fax: +43 (0) 1 890 13 64 - 20
office@eppendorf.at
www.eppendorf.at

BANGLADESH

MBiologix
House # 39 (4th Floor), Road # 14,
Sector # 13
Uttara Model Town
Dhaka-1230
BANGLADESH
Tel: +88-02-8933572
Fax: +88-02-8933484
sales@mbiologix.com

BELGIUM*

Eppendorf Belgium N.V./S.A.
Nijverheidslaan 22
3200 Aarschot
BELGIUM
Tel.: +32 16 52 58 10
Fax: +32 1657 2753
Info-be@eppendorf.be
www.eppendorf.be

BOTSWANA*

Eppendorf Middle East and Africa FZ-LLC
Office G08A, Ground Floor
Dubai Science Park- Nucleotide Complex,
Al Barsha South 2, Um Suqeim Road,
P.O. Box 502019, Dubai
UNITED ARAB EMIRATES
Tel: +971 4 369 29 54
Fax: +971 4 368 82 60
info-dubai@eppendorf.ae
www.eppendorf.ae

ALGERIA

Eurl la Nouvelle Technologie de Santé (N.T.S)
Coopérative Abbas Laghrour
Bt B, No. 02
16308 Kouba Alger
ALGERIA
Tel :+ 213 (0) 21 29 87 52 / 75 /70
Fax:+ 213 (0) 21 29 89 80
nts-dz@hotmail.com

AUSTRALIA*

Eppendorf South Pacific Pty. Ltd.
Level 1, 97 Waterloo Road
Macquarie Park, NSW 2113
AUSTRALIA
Tel.: +61 2 9889 5000
Fax: +61 2 9889 5111
info@eppendorf.com.au
www.eppendorf.com

BAHRAIN

Eppendorf Middle East and Africa FZ-LLC
Office G08A, Ground Floor
Dubai Science Park- Nucleotide Complex,
Al Barsha South 2, Um Suqeim Road,
P.O. Box 502019, Dubai
UNITED ARAB EMIRATES
Tel: +971 4 369 29 54
Fax: +971 4 368 82 60
info-dubai@eppendorf.ae
www.eppendorf.ae

BANGLADESH*

Eppendorf India Private Limited
Plot No: 18, 19, 20 (Part)
Sidco Industrial Estate (South Phase)
Ambattur, Chennai 600 058
INDIA
Tel.: +91 44 66 31 22 22
info@eppendorf.co.in
www.eppendorf.co.in

BHUTAN*

Eppendorf India Private Limited
Plot No: 18, 19, 20 (Part)
Sidco Industrial Estate (South Phase)
Ambattur, Chennai 600 058
INDIA
Tel.: +91 44 66 31 22 22
info@eppendorf.co.in
www.eppendorf.co.in

BRAZIL

Eppendorf do Brasil Ltda.
Rua Presidente Antônio Cândido, nº 80
05083-060. Alto da Lapa – São Paulo
BRAZIL
Tel.: +55 11 3648 5400
eppendorf@eppendorf.com.br
www.eppendorf.com.br

ANGOLA*

Eppendorf Middle East and Africa FZ-LLC
Office G08A, Ground Floor
Dubai Science Park- Nucleotide Complex,
Al Barsha South 2, Um Suqeim Road,
P.O. Box 502019, Dubai
UNITED ARAB EMIRATES
Tel: +971 4 369 29 54
Fax: +971 4 368 82 60
info-dubai@eppendorf.ae
www.eppendorf.ae

AUSTRIA*

Eppendorf Austria GmbH
Ignaz Köck Straße 10/2. OG
1210 Wien
AUSTRIA
Tel: +43 (0) 1 890 13 64 - 0
Fax: +43 (0) 1 890 13 64 - 20
office@eppendorf.at
www.eppendorf.at

BAHRAIN

Al-Faiha for Laboratories & Scientific Supplies
W.L.L.
Al-Sayegh Commercial Centre Building No. 163
F11 King Hussein Street, Abdali
P.O.Box 926209
Amman 11190 Jordan
Tel.: +962 6 465 9609, 4633290 Ext. 105
Fax: +962 6 463 3295
info@sahoury.com

BELARUS

Eppendorf Austria GmbH
Ignaz Köck Straße 10/2. OG
1210 Wien
AUSTRIA
Tel: +43 (0) 1 890 13 64 - 0
Fax: +43 (0) 1 890 13 64 - 20
office@eppendorf.at
www.eppendorf.at

BOSNIA-HERZEGOVINA*

Eppendorf Austria GmbH
Ignaz Köck Straße 10/2. OG
1210 Wien
AUSTRIA
Tel: +43 (0) 1 890 13 64 - 0
Fax: +43 (0) 1 890 13 64 - 20
office@eppendorf.at
www.eppendorf.at

BRUNEI*

Eppendorf Asia Pacific Sdn. Bhd.
10th Floor, Menara Symphony
No. 5, Jalan Prof. Khoo Kay Kim
Seksyen 13
46200 Petaling Jaya, Selangor Darul Ehsan
MALAYSIA
Tel.: +60 3 7610 5200
Fax: +60 3 7610 5252
eppendorf@eppendorf.com.my
www.eppendorf.com.my

BRUNEI

Medicorp Sdn Bhd Block A, Unit 8, 9 & 10
Bangunan Hj Lajim & Anak-Anak, Kg. KiarongBE
1318, BRUNEI
Tel: +673 2424 768 / 769
Fax: +673 2424 770
www.medicorp.biz
sales@medicorp.biz

CANADA*

Eppendorf Canada Ltd.
2810 Argentia Road, Unit # 2
Mississauga, Ontario L5N 8L2
CANADA
Tel.: +1 800 263 8715
+1 905 826 5525
Fax: +1 905 826 5424
canada@eppendorf.com
www.eppendorf.ca

CHINA*

Eppendorf China Ltd.
Guangzhou Office
Room 2006-07, Tower B, China Int'l Center
No.33 Zhong Shan San Road
Guangzhou 510055, P.R.CHINA
Tel.: +86 20 8375 4160
Fax: +86 20 8385 4130
market.info@eppendorf.cn
www.eppendorf.cn

CYPRUS*

Eppendorf Austria GmbH
Ignaz Köck Straße 10/2. OG
1210 Wien
AUSTRIA
Tel: +43 (0) 1 890 13 64 - 0
Fax: +43 (0) 1 890 13 64 - 20
office@eppendorf.at
www.eppendorf.at

EGYPT

Eppendorf Middle East and Africa FZ-LLC
Office G08A, Ground Floor
Dubai Science Park- Nucleotide Complex,
Al Barsha South 2, Um Suqeim Road,
P.O. Box 502019, Dubai
UNITED ARAB EMIRATES
Tel: +971 4 369 29 54
Fax: +971 4 368 82 60
info-dubai@eppendorf.ae
www.eppendorf.ae

ETHIOPIA

Eppendorf Middle East and Africa FZ-LLC
Office G08A, Ground Floor
Dubai Science Park- Nucleotide Complex,
Al Barsha South 2, Um Suqeim Road,
P.O. Box 502019, Dubai
UNITED ARAB EMIRATES
Tel: +971 4 369 29 54
Fax: +971 4 368 82 60
info-dubai@eppendorf.ae
www.eppendorf.ae

BULGARIA*

Eppendorf Austria GmbH
Ignaz Köck Straße 10/2. OG
1210 Wien
AUSTRIA
Tel: +43 (0) 1 890 13 64 - 0
Fax: +43 (0) 1 890 13 64 - 20
office@eppendorf.at
www.eppendorf.at

CHINA*

Eppendorf (Shanghai) International
Trade Co., Ltd.
1001-1007, 10th Floor, The Center
989, Chang Le Road
Shanghai 200031, P.R. CHINA
Tel.: +86 21 38560500
Fax: +86 21 38560555
market.info@eppendorf.cn
www.eppendorf.cn

CHINA*

Eppendorf China Ltd.
Hong Kong Office
Unit 1801-05, Westin Centre
26 Hung To Road, Kwun Tong, Kowloon
HONG KONG SAR, P.R. CHINA
Tel.: +852 3528 8900
Fax: +852 3528 8980
info@eppendorf.hk
www.eppendorf.hk

CZECH REPUBLIC*

Eppendorf Czech & Slovakia s.r.o.
Voděradská 2552/16
251 01 Říčany u Prahy
CZECH REPUBLIC
Tel.: +420 323 605 454
Eppendorf@eppendorf.cz
www.eppendorf.cz

EGYPT**

For Bioprocess:
United Scientific Equipment
24 Elsobky street, Dokki
Giza
EGYPT
Tel: +202 33367880
Fax:+202 37613211
cleobio@link.net

FINLAND*

Eppendorf Nordic A/S
Slotsmarken 12
2970 Horsholm
DENMARK
Tel.: +358 9 88 171 305
nordic@eppendorf.dk
www.eppendorf.dk

CAMBODIA

DKSH Cambodia
10, Street 240
Chaktomuk, Daun Penh District
Phnom Penh City
CAMBODIA
Tel.: +855 23 218 670
Fax: +855 23 218 571
olivier.drouet@dksh.com
www.europcontinents.com; www.dksh.com

CHINA*

Eppendorf (Shanghai) International
Trade Co., Ltd., Beijing Office
Unit 1901, 1902, 1911A, 19F, Tower B, Pacific
Century Place,
A2 North Gongti Road,
Chaoyang District, Beijing 100027, P.R. CHINA
Tel.: +86 10 8836 0998
Fax: +86 10 8836 0501
market.info@eppendorf.cn
www.eppendorf.cn

CROATIA*

Eppendorf Austria GmbH
Ignaz Köck Straße 10/2. OG
1210 Wien
AUSTRIA
Tel: +43 (0) 1 890 13 64 - 0
Fax: +43 (0) 1 890 13 64 - 20
office@eppendorf.at
www.eppendorf.at

DENMARK*

Eppendorf Nordic A/S
Slotsmarken 12
2970 Horsholm
DENMARK
Tel.: +45 43 24 00 00
nordic@eppendorf.dk
www.eppendorf.dk

ESTONIA

Quantum Eesti AS
Saekoja 36a
50107 Tartu
ESTONIA
Tel.: +372 7 301320
Fax: +372 7 304 310
quantum@quantum.ee
www.quantum.ee

FRANCE*

EPPENDORF FRANCE SAS
2/6 rue du Château d'Eau
78360 Montesson
FRANCE
Tel.: +33 1 30 15 67 40
Fax: +33 1 30 15 67 45
eppendorf@eppendorf.fr
www.eppendorf.fr

GERMANY*

Eppendorf Vertrieb
Deutschland GmbH
Peter-Henlein-Straße 2
50389 Wesseling-Berzdorf
GERMANY
Tel.: +49 2232 418-0
Fax: +49 2232 418-155
vertrieb@eppendorf.de
www.eppendorf.de

GHANA

Inqaba Biotech West Africa Ltd
Within the campus of University of Ghana
1st Floor, Dept. of Biochemistry
Cell & Molecular Biology
Legon, Accra,
GHANA
Tel. +233 303 969 327
akwaaba@inqababiotech.ng
www.inqababiotech.ng

HUNGARY*

Eppendorf Austria GmbH
Ignaz Köck Straße 10/2. OG
1210 Wien
AUSTRIA
Tel.: +43 1 890 3 64 0
Fax: +43 1 890 3 64 20
Mobil: +36 20 532 86 97
bosze.z@eppendorf.at
www.eppendorf.hu

INDONESIA*

PT Infiniti Bioanalitika Solusindo
Rukan Grand Aries Niaga
Blok A1. No. 1N
Jl Taman Airies
Jakarta Barat 11620
INDONESIA
Tel.: +62 21 5870 361
Fax: +62 21 5890 6884
sales@ibs.co.id
www.ibs.co.id

INDONESIA*

PT. Enseval Medika Prima,
Jl. Pulo Lentut No. 12,
Jakarta Industrial Estate Pulogadung (JIEP)
East Jakarta 13920, INDONESIA
Tel.: +62 21 4682 3234
Fax: +62 21 4682 2413
customer.care@emp.co.id
www.emp.co.id

GEORGIA

Eppendorf Austria GmbH
Ignaz Köck Straße 10/2. OG
1210 Wien
AUSTRIA
Tel: +43 (0) 1 890 13 64 - 0
Fax: +43 (0) 1 890 13 64 - 20
office@eppendorf.at
www.eppendorf.at

GREECE*

Eppendorf Austria GmbH
Ignaz Köck Straße 10/2. OG
1210 Wien
AUSTRIA
Tel: +43 (0) 1 890 13 64 - 0
Fax: +43 (0) 1 890 13 64 - 20
office@eppendorf.at
www.eppendorf.at

ICELAND*

Eppendorf Nordic A/S
Slotsmarken 12
2970 Horsholm
DENMARK
Tel.: +45 43 24 00 00
nordic@eppendorf.dk
www.eppendorf.dk

INDONESIA**

PT ITS Science Indonesia
Sentra Bisnis Artha Gading
Block A6-A, No. 3 & 5
Jl Boulevard Artha Gading, Kelapa Gading
Jakarta 14240; INDONESIA
Tel.: +62 21 451 6222
Fax.: +62 21 451 6223
info@its-indonesia.com
www.its-indonesia.com

IRAN

Tadjhiz Gostar Co.
No. 168 Taleghani Ave.
P. O. Box 14335 - 153
P.C. 14178 Tehran
IRAN
Tel.: +98 21 6649-8684
Fax: +98 21 6649-5098
info@tadjhizgostar.com
www.tadjhizgostar.com

GHANA

Eppendorf Middle East and Africa FZ-LLC
Office G08A, Ground Floor
Dubai Science Park- Nucleotide Complex,
Al Barsha South 2, Um Suqeim Road,
P.O. Box 502019, Dubai
UNITED ARAB EMIRATES
Tel: +971 4 369 29 54
Fax: +971 4 368 82 60
info-dubai@eppendorf.ae
www.eppendorf.ae

HONG KONG SAR*

Eppendorf China Ltd.
Hong Kong Office
Unit 1801-05, Westin Centre
26 Hung To Road, Kwun Tong, Kowloon
HONG KONG SAR, P.R. CHINA
Tel.: +852 3528 8900
Fax: +852 3528 8980
info@eppendorf.hk
www.eppendorf.hk

INDIA*

Eppendorf India Private Limited
Plot No: 18, 19, 20 (Part)
Sidco Industrial Estate (South Phase)
Ambattur, Chennai 600 058
INDIA
Tel.: +91 44 66 31 22 22
info@eppendorf.co.in
www.eppendorf.co.in

INDONESIA**

PT GaiaScience Indonesia
Kirana Boutique Office Blok D3 No. 3
Jl. Boulevard Raya No. 1
Kelapa Gading, Jakarta 14240
INDONESIA
Tel.: +62 21 4586 0646
Fax.: +62 21 4586 0645
info@gaiascience.co.id
www.gaiascience.co.id

IRAN**

Iran Panam
Iran Panam
1st Floor, Bldg.32
shahid hosseini st.
Karimkhan Av.
Tehran , IRAN
Phone: (+9821) 88321070-4
(+9821) 88841880
Fax: (+9821) 88321069
Email: info@iran-panam.ir
www.iranpanam.ir

IRAQ

Eppendorf Middle East and Africa FZ-LLC
Office G08A, Ground Floor
Dubai Science Park- Nucleotide Complex,
Al Barsha South 2, Um Suqeim Road,
P.O. Box 502019, Dubai
UNITED ARAB EMIRATES
Tel: +971 4 369 29 54
Fax: +971 4 368 82 60
info-dubai@eppendorf.ae
www.eppendorf.ae

IRELAND (Republic)*

Eppendorf UK Limited
Eppendorf House
Gateway 1000 Whittle Way
Arlington Business Park
Stevenage SG1 2FP, UNITED KINGDOM
Tel.: +44 1438 735 888
Fax: +44 1438 735 889
sales@eppendorf.co.uk
www.eppendorf.co.uk

ISRAEL**

For Bioprocess: Small Scale Systems
Danyel Biotech
8 Hamada Street, Science Park
P.O.Box 2417
Rehovot, ISRAEL
Tel.: +972 544606773
guy@danyel.co.il

JORDAN

Al-Faiha for Laboratories & Scientific Supplies
W.L.L.
Al-Sayegh Commercial Centre Building No. 163
F11 King Hussein Street, Abdali
P.O.Box: 926209
Amman 11190 JORDAN
Tel: +962 6 465 9609, 4633290 Ext 105
Fax: +962 6 463 3295
info@sahoury.com

KENYA**

SWAMA
6th Floor, Tausi court, Tausi Road, off Muthithi
Road, Westlands,
P.O. Box 10256-00400
Nairobi
KENYA
Tel: +254 20 3741242
Fax: + 254 20 3742033
swama@africaonline.co.ke

KUWAIT

Central Circle Co.
P.O. Box 1015
Salmieh, 22011
Salmieh
KUWAIT
Tel.: +965 2 241 1758/1748
Fax: +965 2 244 5457
cencico@centralcircleco.com
www.centralcircleco.com

IRAQ

Al-Faiha for Laboratories & Scientific Supplies
W.L.L.
Al-Sayegh Commercial Centre
King Hussein Street, Abdali
P.O Box: 926209
Amman 11190 JORDAN
Tel: +962 6 465 9609, 4633290 Ext. 105
Fax: +962 6 463 3295
info@sahoury.com

ISRAEL

All Products:
Lumitron Ltd.
17 Hamefalsim St. Kiryat Arye
Petah-Tikva 49514
ISRAEL
Tel.: +972 73 2000777
Fax: +972 73 2000763
lumitron@lumitron.co.il
www.lumitron.co.il

ITALY*

Eppendorf s.r.l.
Via Zante 14
20138 Milano
ITALY
Tel.: +390 2 55 404 1
Fax: +390 2 58 013 438
eppendorf@eppendorf.it
www.eppendorf.it

KAZAKHSTAN

Eppendorf Austria GmbH
Ignaz Köck Straße 10/2. OG
1210 Wien
AUSTRIA
Tel: +43 (0) 1 890 13 64 - 0
Fax: +43 (0) 1 890 13 64 - 20
office@eppendorf.at
www.eppendorf.at

KOSOVO*

Eppendorf Austria GmbH
Ignaz Köck Straße 10/2. OG
1210 Wien
AUSTRIA
Tel: +43 (0) 1 890 13 64 - 0
Fax: +43 (0) 1 890 13 64 - 20
office@eppendorf.at
www.eppendorf.at

KYRGYZSTAN

Eppendorf Austria GmbH
Ignaz Köck Straße 10/2. OG
1210 Wien
AUSTRIA
Tel: +43 (0) 1 890 13 64 - 0
Fax: +43 (0) 1 890 13 64 - 20
office@eppendorf.at
www.eppendorf.at

IRAQ**

IFAA Medical Ltd.
Palestine Street 48,
Baghdad
IRAQ
Tel: +964 7808 442 244
Fax: +964 1717 2383
info@ifaa-med.net

ISRAEL**

For Bioprocess:
Bio-Instrument Jerusalem Ltd.
3 Dahomey Street,
Jerusalem 96587
ISRAEL
Tel.: +972 2 6416419
Fax: +972 26438149
bioinstj@zahav.net.il

JAPAN*

Eppendorf Co., Ltd.
Horisho Building
Higashi-Kanda 2-4-5, Chiyoda-ku
Tokyo 101-0031
JAPAN
Tel.: +81 3 5825 2361
Fax: +81 3 5825 2365
info@eppendorf.jp
www.eppendorf.com/jp

KENYA

F & S Scientific Ltd
Shamneel Court,2 Muthithi Road,Westlands
P.O Box 39081-00623
Nairobi, KENYA
Tel: +254 20 3594777
Fax: +254 20 4449633
mail@fnscientific.com
www.fnscientific.com

KUWAIT

Eppendorf Middle East and Africa FZ-LLC
Office G08A, Ground Floor
Dubai Science Park- Nucleotide Complex,
Al Barsha South 2, Um Suqeim Road,
P.O. Box 502019, Dubai
UNITED ARAB EMIRATES
Tel: +971 4 369 29 54
Fax: +971 4 368 82 60
info-dubai@eppendorf.ae
www.eppendorf.ae

LATIN AMERICA*

Eppendorf do Brasil Ltda.
Rua Presidente Antônio Cândido, nº 80
05083-060. Alto da Lapa – São Paulo
BRAZIL
Tel.: +55 11 3648 5400
eppendorf@eppendorf.com.br
www.eppendorf.com.br

LAOS

New Link Lao Sole Co., Ltd
Technology Solutions
Nakhouay Road Unit 2 Baan
Khamsavath Saysettha District
Vientiane
LAOS PDR
Tel.: +856 20 555 18174
newlinklaosts.dir@gmail.com

LEBANON**

IV LAB S.A.R.L.
Baouchrieh-Industrial City-St. Jean center,
2nd floor, Beirut
LEBANON
Tel.: +961 3 962530
Fax: +961 1 875792
tony.hkayem@ivlab-leb.com

LUXEMBOURG*

Eppendorf Belgium N.V./S.A.
Stationsstraat 180/4
3110 Rotselaar
BELGIUM
Tel.: +32 1656 2831
Fax: +32 1657 2753
info@eppendorf.be
www.eppendorf.be

MALAWI*

Eppendorf Middle East and Africa FZ-LLC
Office G08A, Ground Floor
Dubai Science Park- Nucleotide Complex,
Al Barsha South 2, Um Suqeim Road,
P.O. Box 502019, Dubai
UNITED ARAB EMIRATES
Tel: +971 4 369 29 54
Fax: +971 4 368 82 60
info-dubai@eppendorf.ae
www.eppendorf.ae

MAURITIUS*

Eppendorf Middle East and Africa FZ-LLC
Office G08A, Ground Floor
Dubai Science Park- Nucleotide Complex,
Al Barsha South 2, Um Suqeim Road,
P.O. Box 502019, Dubai
UNITED ARAB EMIRATES
Tel: +971 4 369 29 54
Fax: +971 4 368 82 60
info-dubai@eppendorf.ae
www.eppendorf.ae

LATVIA

SIA Quantum Latvia
Balta iela 3/9
Riga LV1055
LATVIA
Tel.: +371 747 29 26
Fax: +371 747 29 39
anna@quantum.lv
www.quantum.lv

LIBYA

Eppendorf Middle East and Africa FZ-LLC
Office G08A, Ground Floor
Dubai Science Park- Nucleotide Complex,
Al Barsha South 2, Um Suqeim Road,
P.O. Box 502019, Dubai
UNITED ARAB EMIRATES
Tel: +971 4 369 29 54
Fax: +971 4 368 82 60
info-dubai@eppendorf.ae
www.eppendorf.ae

MACEDONIA*

Eppendorf Austria GmbH
Ignaz Köck Straße 10/2. OG
1210 Wien
AUSTRIA
Tel: +43 (0) 1 890 13 64 - 0
Fax: +43 (0) 1 890 13 64 - 20
office@eppendorf.at
www.eppendorf.at

MALAYSIA*

Eppendorf Asia Pacific Sdn. Bhd.
10th Floor, Menara Symphony
No. 5, Jalan Prof. Khoo Kay Kim
Seksyen 13
46200 Petaling Jaya, Selangor Darul Ehsan
MALAYSIA
Tel.: +60 3 7610 5200
Fax: +60 3 7610 5252
eppendorf@eppendorf.com.my
www.eppendorf.com.my

MOLDOVA*

Eppendorf Austria GmbH
Ignaz Köck Straße 10/2. OG
1210 Wien
AUSTRIA
Tel: +43 (0) 1 890 13 64 - 0
Fax: +43 (0) 1 890 13 64 - 20
office@eppendorf.at
www.eppendorf.at

LEBANON

Tamer Frères s.a.l.
Tamer Bldgs
Jean Tamer Street
Sin El Fil
P.O.Box 84
Beirut
LEBANON
Tel.: +961 1 499 846+847
Fax: +961 1 510 233+234
elie.gerges@tamer-group.com

LITHUANIA

GRIDA UAB
Molėtų g. 16
Didžioji Riešė
14260 Vilniaus r.
LITHUANIA
Tel.: +370 5 2469435
Fax: +370 5 2469436
Labor@grida.lt
www.grida.lt

MADAGASKAR*

Eppendorf Middle East and Africa FZ-LLC
Office G08A, Ground Floor
Dubai Science Park- Nucleotide Complex,
Al Barsha South 2, Um Suqeim Road,
P.O. Box 502019, Dubai
UNITED ARAB EMIRATES
Tel: +971 4 369 29 54
Fax: +971 4 368 82 60
info-dubai@eppendorf.ae
www.eppendorf.ae

MALTA*

Eppendorf s.r.l.
Via Zante 14
20138 Milano
ITALY
Tel.: +390 2 55 404 1
Fax: +390 2 58 013 438
eppendorf@eppendorf.it
www.eppendorf.it

MONTENEGRO*

Eppendorf Austria GmbH
Ignaz Köck Straße 10/2. OG
1210 Wien
AUSTRIA
Tel: +43 (0) 1 890 13 64 - 0
Fax: +43 (0) 1 890 13 64 - 20
office@eppendorf.at
www.eppendorf.at

GERMANY*

Eppendorf Vertrieb
Deutschland GmbH
Peter-Henlein-Straße 2
50389 Wesseling-Berzdorf
GERMANY
Tel.: +49 2232 418-0
Fax: +49 2232 418-155
vertrieb@eppendorf.de
www.eppendorf.de

GHANA

Inqaba Biotech West Africa Ltd
Within the campus of University of Ghana
1st Floor, Dept. of Biochemistry
Cell & Molecular Biology
Legon, Accra,
GHANA
Tel. +233 303 969 327
akwaaba@inqababiotech.ng
www.inqababiotech.ng

HUNGARY*

Eppendorf Austria GmbH
Ignaz Köck Straße 10/2. OG
1210 Wien
AUSTRIA
Tel.: +43 1 890 3 64 0
Fax: +43 1 890 3 64 20
Mobil: +36 20 532 86 97
bosze.z@eppendorf.at
www.eppendorf.hu

INDONESIA*

PT Infiniti Bioanalitika Solusindo
Rukan Grand Aries Niaga
Blok A1. No. 1N
Jl Taman Airies
Jakarta Barat 11620
INDONESIA
Tel.: +62 21 5870 361
Fax: +62 21 5890 6884
sales@ibs.co.id
www.ibs.co.id

INDONESIA*

PT. Enseval Medika Prima,
Jl. Pulo Lentut No. 12,
Jakarta Industrial Estate Pulogadung (JIEP)
East Jakarta 13920, INDONESIA
Tel.: +62 21 4682 3234
Fax: +62 21 4682 2413
customer.care@emp.co.id
www.emp.co.id

GEORGIA

Eppendorf Austria GmbH
Ignaz Köck Straße 10/2. OG
1210 Wien
AUSTRIA
Tel: +43 (0) 1 890 13 64 - 0
Fax: +43 (0) 1 890 13 64 - 20
office@eppendorf.at
www.eppendorf.at

GREECE*

Eppendorf Austria GmbH
Ignaz Köck Straße 10/2. OG
1210 Wien
AUSTRIA
Tel: +43 (0) 1 890 13 64 - 0
Fax: +43 (0) 1 890 13 64 - 20
office@eppendorf.at
www.eppendorf.at

ICELAND*

Eppendorf Nordic A/S
Slotsmarken 12
2970 Horsholm
DENMARK
Tel.: +45 43 24 00 00
nordic@eppendorf.dk
www.eppendorf.dk

INDONESIA**

PT ITS Science Indonesia
Sentra Bisnis Artha Gading
Block A6-A, No. 3 & 5
Jl Boulevard Artha Gading, Kelapa Gading
Jakarta 14240; INDONESIA
Tel.: +62 21 451 6222
Fax.: +62 21 451 6223
info@its-indonesia.com
www.its-indonesia.com

IRAN

Tadjhiz Gostar Co.
No. 168 Taleghani Ave.
P. O. Box 14335 - 153
P.C. 14178 Tehran
IRAN
Tel.: +98 21 6649-8684
Fax: +98 21 6649-5098
info@tadjhizgostar.com
www.tadjhizgostar.com

GHANA

Eppendorf Middle East and Africa FZ-LLC
Office G08A, Ground Floor
Dubai Science Park- Nucleotide Complex,
Al Barsha South 2, Um Suqeim Road,
P.O. Box 502019, Dubai
UNITED ARAB EMIRATES
Tel: +971 4 369 29 54
Fax: +971 4 368 82 60
info-dubai@eppendorf.ae
www.eppendorf.ae

HONG KONG SAR*

Eppendorf China Ltd.
Hong Kong Office
Unit 1801-05, Westin Centre
26 Hung To Road, Kwun Tong, Kowloon
HONG KONG SAR, P.R. CHINA
Tel.: +852 3528 8900
Fax: +852 3528 8980
info@eppendorf.hk
www.eppendorf.hk

INDIA*

Eppendorf India Private Limited
Plot No: 18, 19, 20 (Part)
Sidco Industrial Estate (South Phase)
Ambattur, Chennai 600 058
INDIA
Tel.: +91 44 66 31 22 22
info@eppendorf.co.in
www.eppendorf.co.in

INDONESIA**

PT GaiaScience Indonesia
Kirana Boutique Office Blok D3 No. 3
Jl. Boulevard Raya No. 1
Kelapa Gading, Jakarta 14240
INDONESIA
Tel.: +62 21 4586 0646
Fax.: +62 21 4586 0645
info@gaiascience.co.id
www.gaiascience.co.id

IRAN**

Iran Panam
1st Floor, Bldg.32
shahid hosseini st.
Karimkhan Av.
Tehran , IRAN
Phone: (+9821) 88321070-4
(+9821) 88841880
Fax: (+9821) 88321069
Email: info@iran-panam.ir
www.iranpanam.ir

PAKISTAN*

Eco Biosciences
1st Floor, 109-W, Sardar Begum Plaza
Blue Area
Islamabad
PAKISTAN
Tel.: +92 51 234 851 59
Fax: +92 51 234 85 20
info@ecobiosciences.com
www.ecobiosciences.com

PALESTINE

Eppendorf Middle East and Africa FZ-LLC
Office G08A, Ground Floor
Dubai Science Park- Nucleotide Complex,
Al Barsha South 2, Um Suqeim Road,
P.O. Box 502019, Dubai
UNITED ARAB EMIRATES
Tel.: +971 4 369 29 54
Fax: +971 4 368 82 60
info-dubai@eppendorf.ae
www.eppendorf.ae

POLAND*

Eppendorf Poland Sp.z o.o
Al. Jerozolimskie 212
02-486 Warszawa
POLAND
Tel. +48 22 571 40 20
Fax +48 22 571 40 30
info@eppendorf.pl
www.eppendorf.pl

QATAR**

Petro Emphor Co. W.L.L
Bldg.# 314, New Salata Area,
P.O.Box. No. 31822,
D' ring Rd, Doha,
QATAR
Tel.: +974 44654563
Fax: +974 44652256
petroemphor@emphor.biz
www.emphorlas.biz

RWANDA*

Eppendorf Middle East and Africa FZ-LLC
Office G08A, Ground Floor
Dubai Science Park- Nucleotide Complex,
Al Barsha South 2, Um Suqeim Road,
P.O. Box 502019, Dubai
UNITED ARAB EMIRATES
Tel: +971 4 369 29 54
Fax: +971 4 368 82 60
info-dubai@eppendorf.ae
www.eppendorf.ae

PAKISTAN**

H. A. Shah & Sons
3rd Floor, 109-W, Sardar Begum Plaza
Jinnah Avenue, Blue Area
Islamabad
PAKISTAN
Tel.: +92 51 227 3557
Fax: +92 51 227 2743
info@hashah.com
www.hashah.com

PHILIPPINES

Chemoscience Phils.Inc.
2825 Park Avenue BRGY 075
Pasay City 1302
Manila
PHILIPPINES
Tel. +63 2 833 7883
Fax: +63 2 253 1603
kytan@chemopharm.com.my
www.chemoscience.com.ph

PORTUGAL*

Eppendorf Ibérica S.L.U.
Avenida Tenerife 2
Edificio 1
28703 San Sebastián de los Reyes
Madrid, SPAIN
Tel.: +34 91 651 76 94
Fax: +34 91 651 81 44
eppendorf-portugal@eppendorf.pt
www.eppendorf.pt

ROMANIA*

Eppendorf Austria GmbH
Ignaz Köck Straße 10/2. OG
1210 Wien
AUSTRIA
Tel: +43 (0) 1 890 13 64 - 0
Fax: +43 (0) 1 890 13 64 - 20
office@eppendorf.at
www.eppendorf.at

SERBIA*

Eppendorf Austria GmbH
Ignaz Köck Straße 10/2. OG
1210 Wien
AUSTRIA
Tel: +43 (0) 1 890 13 64 - 0
Fax: +43 (0) 1 890 13 64 - 20
office@eppendorf.at
www.eppendorf.at

PAKISTAN**

INSTECH
428-4th Floor, Mashriq Centre
Sir Shah Mohammed Suleman Road, Block-14,
Gulshan-e-Iqbal, Karachi-75300
PAKISTAN
Tel. +92 21 494 5487
Fax +92 21 412 5992
instech@cyber.net.pk

PHILIPPINES

PHILAB Industries, Inc.
8/ Hanjin Bldg. 1128 University
Parkway Drive
Bonifacio Global City, Taguig City 1634
PHILIPPINES
Tel.: +63 2 551 9614
Fax: +63 2 897 7732
info@philab.com
www.philab.com

QATAR

Gulfmed Medical Supplies
Zone:7 Al Merqap Alqadeem
St no : 109 Gabr Bin Mohamed
Building no :14, Floor no :1 office no:5&6
Doha/ QATAR
Tel.: +974 44866216
Fax: +974 44878546
sales@gulfmedqatar.com
www.gulfdrug.com

RUSSIA*

Eppendorf Russia LLC
Derbenevskaya quay, 11
Business Center POLLARS
Office Б 301
Moscow 115114
RUSSIA
Tel: +7 495 743 51 23
Fax: +7 495 741 51 22
info@eppendorf.ru

SAUDI ARABIA

Abdulla Fouad for Medical Supplies and Service
Company
P.O. Box 257, Dammam 31411
SAUDI ARABIA
Tel: +966 13 814 1414
Fax: +966 13 810 2100
Hussein.fares@abdulla-fouad.com
www.abdulla-fouad.com

SAUDI ARABIA

Eppendorf Middle East and Africa FZ-LLC
Office G08A, Ground Floor
Dubai Science Park- Nucleotide Complex,
Al Barsha South 2, Um Suqeim Road,
P.O. Box 502019, Dubai
UNITED ARAB EMIRATES
Tel: +971 4 369 29 54
Fax: +971 4 368 82 60
info-dubai@eppendorf.ae
www.eppendorf.ae

SINGAPORE**

ITS Science & Medical Pte Ltd
219, Henderson Road
#11 02 Henderson Industrial Park
Singapore 159556
SINGAPORE
Tel.: +65 6273 0898
Fax.: +65 6273 0810
info@its-sciencemedical.com
www.its-sciencemedical.com

SOUTH AFRICA

Inqaba Biotechnical Industries (Pty) Ltd.
PO Box 14356, Hatfield 0028
Pretoria, SOUTH AFRICA
Tel: +27 12 343 5829
Fax: +27 86 677 8409
Email: info@inqababiotec.co.za
www.inqababiotec.co.za

SOUTH KOREA*

Eppendorf Korea Ltd.
Megazone Building 10F
46,Nonhyeon-ro 85-gil,
Gangnam-gu, Seoul, 06235
SOUTH KOREA
Tel.: +82 1577 4395
Fax: +82 2 2190 7799
cs@eppendorf.kr
www.eppendorf.kr

SOUTH SUDAN*

Eppendorf Middle East and Africa FZ-LLC
Office G08A, Ground Floor
Dubai Science Park- Nucleotide Complex,
Al Barsha South 2, Um Suqeim Road,
P.O. Box 502019, Dubai
UNITED ARAB EMIRATES
Tel: +971 4 369 29 54
Fax: +971 4 368 82 60
info-dubai@eppendorf.ae
www.eppendorf.ae

SINGAPORE

AITBIOTECH Pte Ltd
25 Pandan Crescent # 05-15
TIC TECH Centre
Singapore 128477
SINGAPORE
Tel.: +65 6778 6822
Fax.: +65 6778 2962
sales@aitbiotech.com
www.aitbiotech.com

SLOVAKIA*

Eppendorf Czech & Slovakia s.r.o. – organizačná
zložka
Prírodovedecká fakulta UK v Bratislave
Mlynská dolina
842 15 Bratislava
SLOVAKIA
Tel.: +421 911 181 474
eppendorf@eppendorf.sk
www.eppendorf.sk

SOUTH AFRICA

Merck (Pty) Ltd
1 Friesland Drive
Longmeadow Business Estate
Modderfontein, 1645
SOUTH AFRICA
Tel.: +27 11 3725129
Fax: +27 11 3725398
adele.heath@merckgroup.com
www.merckmillipore.com

SPAIN*

Eppendorf Ibérica S.L.U.
Avenida Tenerife 2
Edificio 1
28703 San Sebastián de los Reyes
Madrid
SPAIN
Tel.: +34 91 651 76 94
Fax: +34 91 651 81 44
eppendorf@eppendorf.es
www.eppendorf.es

SWEDEN*

Eppendorf Nordic A/S
Slotsmarken 12
2970 Horsholm
DENMARK
Tel.: +46 8 222 970
nordic@eppendorf.dk
www.eppendorf.dk

SINGAPORE

VWR Singapore Pte Ltd.
18 Gul Drive
Singapore 629468
SINGAPORE
Tel.: +65 6505 0760
Fax: +65 6264 3780
sales@sg.vwr.com
www.vwr.com

SLOVENIA*

Eppendorf Austria GmbH
Ignaz Köck Straße 10/2. OG
1210 Wien
AUSTRIA
Tel: +43 (0) 1 890 13 64 - 0
Fax: +43 (0) 1 890 13 64 - 20
office@eppendorf.at
www.eppendorf.at

SOUTH AFRICA

Analytical Solutions
370 Angus Crescent,
Northlands Business Park,
29 Newmarket Road,
Northriding, Randburg, 2169
SOUTH AFRICA
Tel.: +27 (0)87 610 0900
Fax: +27 (0)11 704 7713
info@analyticalsolutions.co.za
www.analyticalsolutions.co.za

SRI LANKA

Avon Pharmo Chem (Pvt) Ltd.
No 64 B, Jambugasnulla Road
Nugegoda
SRI LANKA
Tel: +94 11 436 19 09
Fax: +94 11 281 41 58
sales@avonpck.com

SWITZERLAND*

Vaudaux-Eppendorf AG
Im Kirschgarten 30
4124 Schönenbuch
SWITZERLAND
Tel.: +41 61 482 1414
Fax: +41 61 482 1419
eppendorf@eppendorf.ch
www.eppendorf.ch

SYRIA

Eppendorf Middle East and Africa FZ-LLC
Office G08A, Ground Floor
Dubai Science Park- Nucleotide Complex,
Al Barsha South 2, Um Suqeim Road,
P.O. Box 502019, Dubai
UNITED ARAB EMIRATES
Tel: +971 4 369 29 54
Fax: +971 4 368 82 60
info-dubai@eppendorf.ae
www.eppendorf.ae

TAJIKISTAN

Eppendorf Austria GmbH
Ignaz Köck Straße 10/2. OG
1210 Wien
AUSTRIA
Tel: +43 (0) 1 890 13 64 - 0
Fax: +43 (0) 1 890 13 64 - 20
office@eppendorf.at
www.eppendorf.at

TUNISIA*

EPPENDORF FRANCE SAS
2/6 rue du Château d'Eau
78360 Montesson
FRANCE
Tel.: +33 1 30 15 67 40
Fax: +33 1 30 15 67 45
eppendorf@eppendorf.fr
www.eppendorf.fr

TURKEY

For Bioprocess:
SEM Labs
Barbaros Mah. Temmuz Sok.
Sem Plaza No. 6, Atasehir
Istanbul, TURKEY
Tel: +90 533 2755 421
zafer.karkac@sem.com.tr
www.sem.com.tr

UKRAINE

Alsi Ltd.
Shovkunenko str., 8/20
of. 51
03049 Kiev
UKRAINE
Tel.: +380 44 245 3224
info@alsi.kiev.ua or mt@alsi.kiev.ua
www.alsi.ua

TAIWAN

Yu Shing Bio-tech Co., Ltd.
7F.-2, No. 141, Sec. 2, Heping W. Rd.,
Zhongzheng Dist.
Taipei City 100,
TAIWAN (R.O.C.)
Tel.: +886 2100 1008
Fax: +886 2 2522 1018
service@yu-shing.com.tw
www.yu-shing.com.tw/catalog/

TANZANIA*

Eppendorf Middle East and Africa FZ-LLC
P. O. Box 502019
Al Thuraya Tower 1 / Office 901
Media City, Dubai
UNITED ARAB EMIRATES
Tel: +971 4 369 29 54
Fax: +971 4 368 82 60
info-dubai@eppendorf.ae
www.eppendorf.ae

TUNISIA

Biopole
45, Rue Du Japon Imm Le 45
Appart A12
1073 - Montplaisir
TUNISIA
Tel: +216 71 903 975
Fax: +216 71 903 965
biopole@biopole.com.tn
www.biopole-tunisie.com

TURKMENISTAN

Eppendorf Austria GmbH
Ignaz Köck Straße 10/2. OG
1210 Wien
AUSTRIA
Tel: +43 (0) 1 890 13 64 - 0
Fax: +43 (0) 1 890 13 64 - 20
office@eppendorf.at
www.eppendorf.at

UNITED ARAB EMIRATES

Eppendorf Middle East and Africa FZ-LLC
Office G08A, Ground Floor
Dubai Science Park- Nucleotide Complex,
Al Barsha South 2, Um Suqeim Road,
P.O. Box 502019, Dubai
UNITED ARAB EMIRATES
Tel: +971 4 369 29 54
Fax: +971 4 368 82 60
info-dubai@eppendorf.ae
www.eppendorf.ae

TAIWAN

Flamegold Material Corporation
No. 335-9, Sec. 1, Wenhua 2nd Rd.
Linkou Dist.
New Taipei City 244
TAIWAN (R.O.C.)
Tel.: +886 2 2609 8982
Fax: +886 2 2600 7768
cs@flamegold.com.tw

THAILAND*

Eppendorf (Thailand) Co., Ltd.
5 Soi Krungthepkreetha 4,
Huamark, Bangkok,
Bangkok 10240
THAILAND
Tel.: +66 2 379 4212-54
Fax: +66 2 379 4216
info@eppendorf.co.th
www.eppendorf.co.th

TURKEY

Incekalar A. S.
1404. Sok. No: 16,
N. Akar Mah., Balgat
06520 Ankara
TURKEY
Tel.: +90 312 295 25 25
Fax: +90 312 295 25 00
eppendorf@incekara.com.tr
www.incekara.com.tr

UGANDA*

Eppendorf Middle East and Africa FZ-LLC
Office G08A, Ground Floor
Dubai Science Park- Nucleotide Complex,
Al Barsha South 2, Um Suqeim Road,
P.O. Box 502019, Dubai
UNITED ARAB EMIRATES
Tel: +971 4 369 29 54
Fax: +971 4 368 82 60
info-dubai@eppendorf.ae
www.eppendorf.ae

UNITED ARAB EMIRATES

Gulf Drug L.L.C.
Next to Saleh Bin Lahej Building, Al Barsha 1
P.O.Box 3264
Dubai
UNITED ARAB EMIRATES
Tel.: +971 4 501 4000
Fax: +971 4 501 4100
info@gulfdrug.com
www.gulfdrug.com

UNITED KINGDOM*

Eppendorf UK Limited
Eppendorf House
Gateway 1000 Whittle Way
Arlington Business Park
Stevenage SG1 2FP, UNITED KINGDOM
Tel.: +44 1438 735 888
Fax: +44 1438 735 889
sales@eppendorf.co.uk
www.eppendorf.co.uk

VIETNAM

BCE Vietnam Office in Hanoi
10th Floor, LICOI 13 Tower,
No.164 Khuat Duy Tien Str.
Thanh Xuan District
Hanoi, VIETNAM
Tel.: +84 4 3234 5666
Fax: +84 4 3234 5668
infors@bcevietnam.com.vn
www.bcevietnam.com.vn

YEMEN*

Eppendorf Middle East and Africa FZ-LLC
Office G08A, Ground Floor
Dubai Science Park- Nucleotide Complex,
Al Barsha South 2, Um Suqeim Road,
P.O. Box 502019, Dubai
UNITED ARAB EMIRATES
Tel: +971 4 369 29 54
Fax: +971 4 368 82 60
info-dubai@eppendorf.ae
www.eppendorf.ae

USA*

Eppendorf North America, Inc.
102 Motor Parkway
Hauppauge, NY 11788-5178
USA
Tel.: +1 800 645 3050
+1 516 334 7500
Fax: +1 516 334 7506
info@eppendorf.com
www.eppendorf.com

VIETNAM

BCE Vietnam Office in Ho Chi Minh City
49/3 Hoang Du Khuong Road, District 10,
Ho Chi Minh City
VIETNAM
Tel.: +84 8 6290 5623
Fax: +84 8 6290 5622
infors@bcevietnam.com.vn
www.bcevietnam.com.vn

ZAMBIA*

Eppendorf Middle East and Africa FZ-LLC
Office G08A, Ground Floor
Dubai Science Park- Nucleotide Complex,
Al Barsha South 2, Um Suqeim Road,
P.O. Box 502019, Dubai
UNITED ARAB EMIRATES
Tel: +971 4 369 29 54
Fax: +971 4 368 82 60
info-dubai@eppendorf.ae
www.eppendorf.ae

UZBEKISTAN

Eppendorf Austria GmbH
Ignaz Köck Straße 10/2. OG
1210 Wien
AUSTRIA
Tel: +43 (0) 1 890 13 64 - 0
Fax: +43 (0) 1 890 13 64 - 20
office@eppendorf.at
www.eppendorf.at

VIETNAM**

An Duong Science Technological Equipment
Company Ltd.
4th Floor, Sapphire Building, 163 Ba Trieu Street,
Le Dai Hanh Ward, Hai Ba Trung District
Hanoi, VIETNAM
Tel.: +84 24 3861 2612
Fax.: +84 24 3863 1616
info@adgroup.vn
www.adgroup.vn

ZIMBABWE*

Eppendorf Middle East and Africa FZ-LLC
Office G08A, Ground Floor
Dubai Science Park- Nucleotide Complex,
Al Barsha South 2, Um Suqeim Road,
P.O. Box 502019, Dubai
UNITED ARAB EMIRATES
Tel: +971 4 369 29 54
Fax: +971 4 368 82 60
info-dubai@eppendorf.ae
www.eppendorf.ae

Legal Notices, Trademarks, patent and design Attributions

Eppendorf group patents:

Eppendorf is the owner of numerous patents worldwide. Please respect our intellectual property. The following products and services are protected by patents in the US and in other countries. The purpose of this catalog is to fulfill the provisions for the virtual arrogation of patents of the "America Invents Act". The following list of the products and services supplied by the Eppendorf group may be incomplete, and other products and services supplied by the Eppendorf group which are not listed here may be protected by American patents or patents of other countries. Any information on patents for products and services which are not listed in this catalog will be stated on the products, on the packaging or on the inserts, if in doubt, please check these. In addition to the patents listed below, other patents may have been applied for.

Disclaimer

epMotion® M5073, M5073c, 5073m, 5073mc and 5075m
This product and its use may be covered by one or more patents owned by Gen-Probe Incorporated. The purchase price for this product includes only limited, nontransferable rights under certain claims of certain patents owned by Gen-Probe Incorporated to use this product for research purposes only. No other rights are conveyed. Purchaser is not granted any rights under patents of Gen-Probe Incorporated to use this product for any commercial use. Further information regarding purchasing a licence under patents of Gen-Probe Incorporated to use this product for any other purposes, including without any limitation, for commercial use, may be obtained by contacting Gen-Probe Incorporated, Attn: Business Development Department, 10210 Genetic Center Drive; San Diego California 92121-4362, U.S.A.

Trademark Information:

The trademarks of the Eppendorf group are recognized worldwide. Please respect our brands as we will protect their use.

US Patents Eppendorf Group

Product	Patent number
BioBLU® 5p, BioBLU® 5c, BioBLU® 14c, BioBLU® 50c	US 8,522,996
BioBLU® 0.3c, BioBLU® 1c, BioBLU® 3c, BioBLU® 5c, BioBLU® 5p, BioBLU® 10c, BioBLU® 14c, BioBLU® 50c	US 9,347,912
BioBLU® 0.3c, BioBLU® 0.3f, BioBLU® 1c, BioBLU® 1f, BioBLU® 3c, BioBLU® 3f, BioBLU® 10c, BioBLU® 10f	US 10,030,220
BioFlo® 510, BioFlo® 610, BioFlo® PRO	US 8,292,591
Centrifuge 5418R, 5424R, 5427R, 5430R, 5702R, 5702RH, 5804R, 5810R, 5910 R, 5910R (NF 5810R) 230V, 5910R (NF 5810R) 120V ENA, 5910R (NF 5810R) 100V Jap, 5920R	US 6,866,621
Centrifuge 5418R, 5424R, 5430R, 5427R	US 8,845,967
Centrifuge 5424R, 5427R	US 8,783,737
Centrifuge 5418, 5418 R, 5424, 5702, 5702R, 5702RH	US 7,029,040
Centrifuge 5425, 5420, 5419	US 9,149,815
Centrifuge 5702 swing-bucket rotor	US 6,746,391
Aerosol-tight fixed-angle rotor for Centrifuges 5920R, 5804, 5804R, 5810, 5810R, 5427R, 5430, 5430R, 5418, 5418R	US 9,149,815

Combitips advanced® 25ml / 50ml	US 8,839,685 US 8,813,584 US 9,291,529
Combitips advanced®	US 8,813,584 US 9,291,529
Easypet® 3	US 9,028,774
Electrofusion Buffers	US 7,157,257
Electroporation Buffer	US 7,157,257
ep Dualfilter T.I.P.S.® SealMax	US 9,138,741
epMotion® 5073; epMotion® 5075	US 8,377,396
epMotion® 5075 VAC	US 6,666,978
Eppendorf BioSpectrometer® Family	US 8,464,171
Eppendorf Cell Culture Flasks (all)	US 9,708,576
Eppendorf Cell Culture Flasks (all Flasks with plug-seal cap)	US 9,776,771
Eppendorf DNA LoBind Produkte	US 9,937,492
Eppendorf Deepwell Plate	US 8,636,965
Eppendorf Injectman® 4	US 9,644,763
Eppendorf Microplates	US 8,636,965
Eppendorf PiezoXpert®	US 9,422,520
Eppendorf Reference® 2	US 7,674,432 US 8,297,134 US 9,044,749
Eppendorf Reference® 2 multi channel	US 7,673,532 US 9,339,811 US 9,393,561
Eppendorf Reference® 2 single channel ≤ 1000 µl	US 7,434,484
Eppendorf Reference® 2 multi channel	US 9,027,419
Eppendorf Reference® 2 variable	US 9,295,986
Eppendorf Research® plus	US 7,674,432 US 8,133,453 US 8,297,134
Eppendorf Research® plus ≤ 1000 µl	US 7,434,484
Eppendorf Research® plus multi channel	US 7,673,532 US 9,393,561
Eppendorf ThermoMixer® C	US 8,827,540 US 9,016,929 US 9,352,323
Eppendorf ThermoMixer® F0.5, F1.5, F2.0	US 8,827,540 US 9,016,929
Eppendorf ThermoMixer® FP	US 8,827,540 US 9,352,323
Eppendorf ThermoStat™ C	US 9,352,323
Eppendorf TransferMan® 4r	US 9,644,763 US 10,071,486 US 10,086,376
Eppendorf TransferMan® 4m	US 9,644,763 US 10,071,486 US 10,086,376
Eppendorf Xplorer®/ Eppendorf Xplorer® plus	US 7,674,432 US 7,694,592 US 8,028,592 US 8,096,198 US 8,570,051 US 9,403,163 US 9,579,645
Eppendorf Xplorer®/Eppendorf Xplorer® plus multi channel	US 7,673,532 US 9,393,561

Eppendorf Xplorer®/Eppendorf Xplorer® plus single channel ≤ 1.000 µl	US 7,434,484
Eppendorf Xplorer®/Eppendorf Xplorer® plus multi channel <1.250 µl	
Eppendorf µCuvette®	US 9,677,994
Gripping tool for epMotion® 5073; epMotion® 5075	US 7,462,327
Innova S44i	US 8,226,291
MagSep reagent kits	US 8,940,248
Mastercycler® pro Family	US 8,492,137 US 8,722,394
Mastercycler® pro Family; Mastercycler® nexus Family	US 8,322,918 US 8,722,394
Mastercycler® X50 Family	US 8,722,394
MixMate®	US 7,575,363 US 8,550,696
Multipette®/Repeater family	US 8,114,361 US 9,011,799 US 9,579,645
Multipette®/Repeater M4	US 8,408,079 US 9,180,446 US 8,813,584 US 9,291,529 US 9,289,762 US 9,579,644
Multipette®/Repeater® stream/ Xstream, Multipette®/ Repeater® E3/ E3x	US 7,731,908 US 8,813,584 US 9,291,529 US 9,289,762
Multipette®/Repeater® E3x	US 9,835,600
Optical sensor epMotion®; epMotion® 5070, 5057 - all types	US 6,819,437
PCR Cooler	US 6,616,897
Pipetting tool for epMotion®	US 8,377,396
twin.tec PCR Plates	US 6,340,589 US 7,347,977 US 7,767,153 US 8,636,965
DASbox® Mini Bioreactor System	US 9,745,547

US Design Patents Eppendorf Group

Product	Patent number
Eppendorf Research® plus	US D625429
Eppendorf ThermoMixer®	US D569988 US D731237 US D759265 US D759266 US D798468 US D798467 US D798466
Eppendorf Plates®	US D601713 US D601714
Eppendorf Xplorer®	US D674913
Eppendorf µCuvette®	US D731671
Multipette® stream and Multipette® Xstream	US D548358
ep Dualfilter T.I.P.S.®	US D679826
epMotion® 96 Interface	US D771661
Eppendorf Centrifuge Rotor	US D760400

Eppendorf Combitips®	US D709623 US D706946 US D733909 US D733910 US D740436 US D740437 US D782619
----------------------	--

Trademarks Eppendorf Group











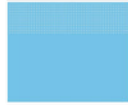



Trademark	Status	Owner
BioBLU	®	Eppendorf AG
BioCommand	®	Eppendorf, Inc.
BioFlo	®	Eppendorf, Inc.
Biomaster	®	Eppendorf AG
Biopur	®	Eppendorf AG
CCCadvanced	®	Eppendorf AG
cellferm-pro	®	DASGIP Information and Process Technology GmbH
CellGem	®	Eppendorf, Inc.
CelliGen	®	Eppendorf, Inc.
CellTram	®	Eppendorf AG
CellXpert	®	Eppendorf AG
Combilong	®	Eppendorf AG
Combitips	®	Eppendorf AG
Combitips advanced	®	Eppendorf AG
Combitips plus	®	Eppendorf AG
condens.protect	®	Eppendorf AG
ConvexAccess	™	Eppendorf AG
CryoCube	®	Eppendorf AG
DASbox	®	DASGIP Information and Process Technology GmbH
DASGIP	®	DASGIP Information and Process Technology GmbH
DASware	®	DASGIP Information and Process Technology GmbH
DualSpeed	™	Eppendorf AG
Easypet	®	Eppendorf AG
eLAB	™	Bio-ITech BV
eLabJournal	®	Bio-ITech BV
ep Dualfilter T.I.P.S.	®	Eppendorf AG
epBlue	™	Eppendorf AG
epGreen	®	Eppendorf AG
epMotion	®	Eppendorf AG
Eppendorf	®	Eppendorf AG
Eppendorf µCuvette	®	Eppendorf AG
Eppendorf Advantage	™	Eppendorf AG
Eppendorf BioPhotometer	®	Eppendorf AG
Eppendorf BioPhotometer plus	®	Eppendorf AG
Eppendorf BioSpectrometer	®	Eppendorf AG
Eppendorf Combitips	®	Eppendorf AG
Eppendorf EasyCon	™	Eppendorf AG
Eppendorf Epurator	®	Eppendorf AG
Eppendorf Kit rotor	®	Eppendorf AG
Eppendorf LoBind	®	Eppendorf AG
Eppendorf MagSep	™	Eppendorf AG
Eppendorf PerfectPiston	®	Eppendorf AG











Legal Notices, Trademarks, patent and design Attributions

Trademark	Status	Owner
Eppendorf PhysioCare Concept	®	Eppendorf AG
Eppendorf PiezoXpert	®	Eppendorf AG
Eppendorf Plates	®	Eppendorf AG
Eppendorf Quality	™	Eppendorf AG
Eppendorf QuickLock	®	Eppendorf AG
Eppendorf QuickRelease	™	Eppendorf AG
Eppendorf Reference	®	Eppendorf AG
Eppendorf Research	®	Eppendorf AG
Eppendorf Research pro	®	Eppendorf AG
Eppendorf SmartBlock	™	Eppendorf AG
Eppendorf SpectraZoom	®	Eppendorf AG
Eppendorf ThermoMixer	®	Eppendorf AG
Eppendorf ThermoMixer 1.5 mL	®	Eppendorf AG
Eppendorf ThermoMixer plates	®	Eppendorf AG
Eppendorf ThermoStat	™	Eppendorf AG
Eppendorf ThermoStat expert	®	Eppendorf AG
Eppendorf ThermoTop	®	Eppendorf AG
Eppendorf Top Buret	™	Eppendorf AG
Eppendorf Tubes	®	Eppendorf AG
Eppendorf twin.tec	®	Eppendorf AG
Eppendorf Varitips	®	Eppendorf AG
Eppendorf Xplorer	®	Eppendorf AG
Eppi	®	Eppendorf AG
epPoints	®	Eppendorf AG
epServices for premium performance	®	Eppendorf AG
epT.I.P.S.	®	Eppendorf AG
Excella	®	Eppendorf, Inc.
FastTemp pro	®	Eppendorf AG
fedbatch-pro	®	DASGIP Information and Process Technology GmbH
FemtoJet	®	Eppendorf AG
Femtotips	®	Eppendorf AG
flexlid	®	Eppendorf AG
Flex-Tube	®	Eppendorf AG
Galaxy	®	Eppendorf, Inc.
GELoader	®	Eppendorf AG
g-Safe	®	Eppendorf AG
HEF	®	Eppendorf, Inc.
In touch with life	®	Eppendorf AG
InjectMan	®	Eppendorf AG
Innova	®	Eppendorf, Inc.
IsoTherm-System	®	Eppendorf AG
Masterclear	®	Eppendorf AG
Mastercycler	®	Eppendorf AG
Mastertip	®	Eppendorf AG
Maxipettor	®	Eppendorf AG
Microloader	™	Eppendorf AG
MiniSpin	®	Eppendorf AG
MixMate	®	Eppendorf AG
Movelt	®	Eppendorf AG
Multipette	®	Eppendorf AG
Multipette smart	®	Eppendorf AG

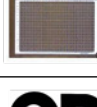
Trademark	Status	Owner
Multiporator	®	Eppendorf AG
Nanotip	®	Eppendorf AG
New Brunswick	™	Eppendorf AG
OptiBowl	®	Eppendorf AG
OptiTrack	®	Eppendorf AG
PhysioCare Concept	®	Eppendorf AG
PourMatic	®	Eppendorf, Inc.
Picaso	®	Eppendorf AG
Pipet Helper	®	Eppendorf AG
RecoverMax	®	Eppendorf AG
Repeater	®	Eppendorf AG
SafeCode	™	Eppendorf AG
SciVario	™	Eppendorf AG
Silence Speed Simplicity	®	Eppendorf AG
SnapTec	™	Eppendorf AG
SplashProtect	™	Eppendorf AG
STAGBIO	®	Eppendorf AG
SteadySlope	®	Eppendorf AG
TransferMan	®	Eppendorf AG
TransferTip	®	Eppendorf AG
Transjector	®	Eppendorf AG
UVette	®	Eppendorf AG
Vacufuge	®	Eppendorf AG
vapoprotect	®	Eppendorf AG
Varipette	®	Eppendorf AG
Varispenser	®	Eppendorf AG
VersaBay	™	Eppendorf AG
ViscoTip	®	Eppendorf AG
VisioNize	®	Eppendorf AG



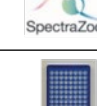
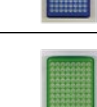
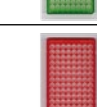





Figurative marks / 3D marks

Trademark	Status	Owner
	®	Eppendorf AG
	®	Eppendorf AG
	®	Eppendorf AG
	®	Eppendorf AG
	®	Eppendorf AG
	®	Eppendorf AG
	®	Eppendorf AG
	®	Eppendorf AG
	®	Eppendorf AG
	®	Eppendorf AG
	®	Eppendorf AG
	®	Eppendorf AG
	®	Eppendorf AG
	®	Eppendorf AG

Trademark	Status	Owner
	®	Eppendorf AG
	®	Eppendorf AG (USPTO)
	®	Eppendorf AG
	®	Eppendorf AG
	®	Eppendorf AG
	®	Eppendorf AG
	®	Eppendorf AG
	®	Eppendorf AG
	®	Eppendorf AG
	®	Eppendorf AG
	®	Eppendorf AG
	®	Eppendorf AG
	®	Eppendorf AG

Legal Notices, Trademarks, patent and design Attributions

Figurative marks

Trademark	Status	Owner
	®	Eppendorf AG
	®	Eppendorf AG
	®	Eppendorf AG
	®	Eppendorf AG
	®	Eppendorf AG
	TM	Eppendorf AG
	®	Bio-ITech BV
	®	Bio-ITech BV
	®	Calibration Technology LTD.

Further Trademarks

Trademark	Status	Owner
AddThis	®	Addthis Inc.
Adidas	®	Adidas AG
Adobe	®	Adobe Systems Inc.
Adobe Flash	®	Adobe Systems Inc.
Adobe logo	®	Adobe Systems Inc.
Allen Bradley	™	Rockwell Automation Inc.
Amazon	®	Amazon Europe Holding Tech. SCS
American Express	®	The American Express Company
Android	™	Google Inc.
anlytica	®	Messe München GmbH
Apple	®	Apple Inc.
Applikon	®	Applikon B.V.
Axio	®	Carl-Zeiss-Stiftung DBA Carl Zeiss
Axiovert	®	Carl-Zeiss-Stiftung DBA Carl Zeiss
Biochrom	®	Harvard Apparatus, Inc
BIODISCOVERY	®	BioDiscovery, Inc.
Bio-Rad	®	Bio-Rad Laboratories
BioSpec	®	Secomam & Societe d'etudes et de construction
Brij	®	Croda Americas LLC
Centriprep	®	Millipore Corporation
Centronics	®	Centronics Data Computer Corporation
CompactLogix	™	Rockwell Automation Inc.
Cryotube	®	Vanguard International, Inc
Cryovial	®	Simport Plastiques Corporation
Diaphot	®	Nikon Inc
Duran	®	Schott AG
ErgoOne	®	Starlab International GmbH
ErgoOne logo	®	Starlab International GmbH
Excel	®	Microsoft Corporation
Facebook	®	Facebook Inc.
Falcon	®	Becton, Dickinson and Company
Fibra-Cel	®	Imerys Minerals California, Inc.
Ficoll	®	Pharmacia Fine Chemicals, Inc.
Fortron	®	Fortron Industries Corporation
FTA	®	Flinders Technologies Pty Ud.
FugeOne	®	Starlab International GmbH
Fujifilm	®	Fuji Photo Film Co., Ltd.
GAMP	®	International Society For Pharmaceutical Engineering Inc.
GE Healthcare	®	General Electric Company
Genequant	®	Harvard Apparatus, Inc
GEO	®	Gruner + Jahr AG & Co KG
GEO schützt den Regenwald e.V. logo	®	Gruner + Jahr AG & Co KG
GEO.DE	®	Gruner + Jahr AG & Co KG
Google Apps	™	Google Inc.

Trademark	Status	Owner
Google Maps	™	Google Inc.
Google Store	™	Google Inc.
HAMA	®	HAMA GmbH & Co. KG.
HARIBO	®	HARIBO GmbH
Hellma	®	Hellma GmbH
Hitachi	®	Hitachi, Ud
ilmac	®	MCH Group AG
ImaGene	®	BioDiscovery, Inc.
in-cosmetics	®	Reed Exhibitions Ltd.
Interphex	®	Reed Elsevier Properties Inc.
iOS	®	Apple Inc.
iPad	®	Apple Inc.
iPhone	®	Apple Inc.
iPod	®	Apple Inc.
iPod touch	®	Apple Inc.
ISM	®	Mettler-Toledo AG
iTunes	®	Apple Inc.
LabMed	®	Medirex a.s.
Laborama	®	UDIAS A.S.B.L
Leatherman	®	Leatherman Tool Group Inc.
Leica	®	Leica Technology
Leica logo	®	Leica Technology
LightCycler	®	Roche Diagnostics GmbH
Maglite	®	MAG Instrument, Inc.
MasterCard	®	MasterCard International tncorporated
Mathlab	®	Mathworks Inc.
MegaBACE	®	Amersham Pharmacia Biotech
Mettler Toledo	®	Mettler-Toledo AG
MICROONE	®	Starlab International GmbH
Microsoft	®	Microsoft Corporation
Microtainer	®	Becton , Dickinson And Company
Moleskine	®	Moleskine S.R.L.
MVS	®	MaeLean-Fogg Company
Nalgene	®	Nalge Nunc International Corp.
Nikon	®	Nikon Inc.
Nikon logo	®	Nikon Inc.
NIST	®	National Institute of Standards and Technology U.S.Department of Commerce
Nunc	®	Nunc NS Corporation
Ohaus	®	Ohaus Cooperation
Olympus	®	Olympus Optical Co., Ltd
Olympus logo	®	Olympus Optical Co., Ltd
Oregon Scientific	®	Oregon Scientific Inc.
Ortlieb	®	Ortlieb
Pentium	®	Intel Corporation
PerkinElmer	®	PerkinElmer, Inc.

Trademark	Status	Owner
Philips	®	Philips GmbH
PicoGreen	®	Molecular Probes, Inc.
Plexiglas	®	Arkema Inc.
QIAGEN	®	QIAGEN GmbH
Red dot design award logo	®	red dot GmbH & Co. KG
Reisenthal	®	Reisenthal
RepeatOne	®	Starlab International GmbH
SanDisk	®	SanDisk Corp.
Sartorius	®	Sartorius AG
SENSEO	®	Koninklijke Douwe Egberts B.V.
Shimadzu	®	Shimadzu Corporation
SIGG	®	SIGG Switzerland AG
SmartCycler	®	Cepheid Corporation
Speedminton	®	Speedminton GmbH
SQL Server	®	Microsoft Corporation
STAR LAB logo	®	Starlab International GmbH
Techne	®	Techne Corporation
Thermo Fisher Scientific	®	Thermo Fisher Scientific, Inc.
TIPONE	®	USA Scientific Inc.
TIPONE L	®	USA Scientific Inc.
Triton	®	Union Carbide Chemicals & Plastics Inc.
TUBEONE	®	Starlab International GmbH
TÜV Nord logo	®	TÜV Nord GmbH
Tween	®	ICI Americas, Inc.
Twitter	®	Twitter Inc.
UVEX	®	UVEX Med. LLC Lim.
Vacutainer	®	Becton, Dickinson and Company
VISA	®	Visa International Service Association
Windows	®	Microsoft Corporation
YouTube	®	Google Inc.
Zeiss	®	Carl-Zeiss-Stiftung DM Carl Zeiss
Zeiss logo	®	Carl-Zeiss-Stiftung DM Carl Zeiss

Application and Technical support



North America:
+1 800 645 3050, menu option 2
techserv@eppendorf.com

Asia Pacific:
+603 8023 6869
support_asiapacific@eppendorf.com



Eppendorf Online Shop
www.eppendorf.com/eshop



Your local distributor:
www.eppendorf.com/contact

Helago-CZ s.r.o.
Kladská 1082
500 03 Hradec Králové
Tel.: 495 220 229, 495 220 394
Fax: 495 220 154
<http://www.helago-cz.cz>
E-mail: info@helago-cz.cz

Eppendorf® and the Eppendorf logo are registered trademarks of Eppendorf AG, Germany. U.S. Design Patents are listed on www.eppendorf.com/ip. All rights reserved, including graphics and images. Order No.: AK01001120/EN1/9.3T/12019/OMP/Konradin Heckel. Copyright© 2020 by Eppendorf AG.

Eppendorf Bioprocessing-Catalog. More info at www.eppendorf.com/catalog



Your local distributor: www.eppendorf.com/contact
Eppendorf AG · Barkhausenweg 1 22339 · Hamburg · Germany
Eppendorf North America, Inc. · USA · Phone: +1 800 645 3050 · Email: info@eppendorf.com